

2024 FORD TRANSIT Owner's Manual

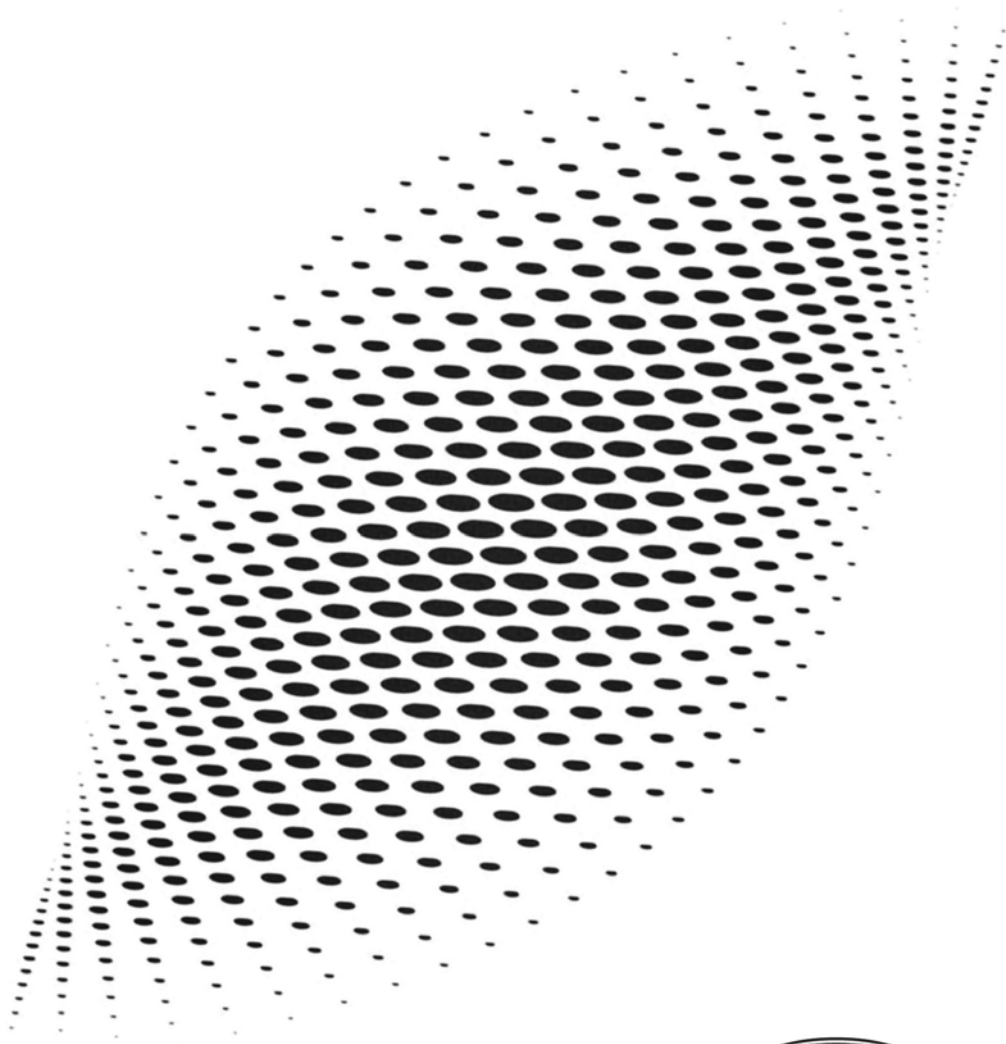

The information contained in this publication was correct at the time of release. In the interest of continuous development, we reserve the right to change specifications, design or equipment at any time without notice or obligation. No part of this publication may be reproduced, transmitted, stored in a retrieval system or translated into any language in any form by any means without our written permission. Errors and omissions excepted.

© Ford Motor Company 2023

All rights reserved.

Part Number: RK3J 19A321 AA-202308-20231012131454

California Proposition 65



WARNING: Operating, servicing and maintaining a passenger vehicle or off-highway motor vehicle can expose you to chemicals including engine exhaust, carbon monoxide, phthalates, and lead, which are known to the State of California to cause cancer and birth defects or other reproductive harm. To minimize exposure, avoid breathing exhaust, do not idle the engine except as necessary, service your vehicle in a well-ventilated area and wear gloves or wash your hands frequently when servicing your vehicle. For more information go to www.P65Warnings.ca.gov/passenger-vehicle.



WARNING: Battery posts, terminals and related accessories contain lead and lead compounds, chemicals known to the State of California to cause cancer and reproductive harm.
Wash your hands after handling.

Table of Contents

Contacting Us

Contacting Us	17
---------------------	----

Introduction

About This Publication	19
Using This Publication	19
Warnings and Notes Used in This Publication	19

Symbols Glossary

Symbols Used on Your Vehicle	20
------------------------------------	----

Data Privacy

Data Privacy - Gasoline	23
Data Privacy - Battery Electric Vehicle	24
Service Data - Gasoline	25
Service Data - Battery Electric Vehicle	26
Event Data	26
Settings Data	27
Connected Vehicle Data	27
Mobile Device Data - Vehicles With: SYNC 4	28
Emergency Call System Data - Gasoline	28
Emergency Call System Data - Battery Electric Vehicle	29

Environment

Protecting the Environment	30
----------------------------------	----

Visual Search

Steering Wheel	31
Instrument Panel - Vehicles With: SYNC 4	31
Instrument Panel - Vehicles With: SYNC 3 Lite, Vehicles Without: SYNC	32

Child Safety

Child Safety Precautions	34
--------------------------------	----

Child Restraints	36
Installing Child Restraints	38
Booster Seats	48
Child Safety Locks	50

Seatbelts

Seatbelt Precautions	51
Fastening and Unfastening the Seatbelts	51
Sensitive Locking Mode	52
Automatic Locking Mode	52
Adjusting the Seatbelts During Pregnancy	53
Adjusting the Seatbelt Height	54
Adjusting the Seatbelt Length	54
Seatbelt Reminder	54
Checking the Seatbelts	57
Seatbelt Extensions	57

Personal Safety System™

What Is the Personal Safety System	59
How Does the Personal Safety System Work	59
Personal Safety System Components	59

Airbags

How Do the Front Airbags Work	60
How Do the Side Airbags Work	60
How Does the Safety Canopy™ Work	61
Airbag Precautions	62
Switching the Passenger Airbag On and Off	63
Properly Adjusting the Driver and Front Passenger Seats	67
Children and Airbags	67
Crash Sensors and Airbag Indicator	68
Disposing of Airbags	69

Table of Contents

Pedestrian Alert System

What Is the Pedestrian Alert System	70
Pedestrian Alert System – Troubleshooting	70

911 Assist

What Is 911 Assist	71
How Does 911 Assist Work - Gasoline	71
How Does 911 Assist Work - Battery Electric Vehicle	71
Emergency Call Requirements	72
Emergency Call Limitations	72

Keys and Remote Controls

Remote Control Limitations	73
Opening and Closing the Flip Key	73
Removing the Key Blade - Vehicles With: Push Button Start	73
Sounding the Panic Alarm	74
Locating Your Vehicle	74
Changing the Remote Control Battery - Vehicles With: Keyed Ignition	74
Changing the Remote Control Battery - Vehicles With: Push Button Start	75
Replacing a Lost Key or Remote Control	77
Programming the Remote Control	77
Keys and Remote Controls Audible Warnings - Vehicles With: Keyed Ignition	77
Keys and Remote Controls Audible Warnings - Vehicles With: Push Button Start	77
Keys and Remote Controls – Troubleshooting	78
Frequently Asked Questions	78

MyKey™

What Is MyKey	79
MyKey Settings	79

Creating a MyKey - Vehicles With: Keyed Ignition	80
Creating a MyKey - Vehicles With: Push Button Start	80
Programming a MyKey	80
Clearing All MyKeys	81
Checking MyKey System Status	81
Using MyKey With Remote Start Systems	81
MyKey – Troubleshooting	81

Doors and Locks

Operating the Doors From Outside Your Vehicle	85
Operating the Doors From Inside Your Vehicle	86
Reprogramming the Unlocking Function	88
Autounlock	88
Autolock	89
Autorelock	89
Doors and Locks Audible Warnings	89
Doors and Locks – Troubleshooting	89

Sliding Door

Sliding Door Precautions	91
Opening the Sliding Door	91
Closing the Sliding Door	92

Keyless Entry

What Is Keyless Entry	93
Keyless Entry Limitations	93
Keyless Entry Settings	93
Using Keyless Entry	93
Keyless Entry – Troubleshooting	94

Keyless Entry Keypad

What Is the Keyless Entry Keypad	95
Keyless Entry Keypad Limitations	95
Locating the Keyless Entry Keypad	95

Table of Contents

Keyless Entry Keypad Master Access Code	95	Adjusting the Instrument Panel Lighting Brightness	110
Keyless Entry Keypad Personal Access Codes	95	Cargo Lamps - Van	111
Using the Keyless Entry Keypad	96	Windows	
Keyless Entry Keypad – Troubleshooting	96	Opening and Closing the Windows	112
		Window Bounce-Back	112
Security		Interior Mirror	
Passive Anti-Theft System	97	Interior Mirror Precautions	114
Anti-Theft Alarm System	97	Manually Dimming the Interior Mirror	114
Security – Troubleshooting	98	Auto-Dimming Interior Mirror	114
		Digital Interior Mirror	114
Steering Wheel		Exterior Mirrors	
Adjusting the Steering Wheel	100	Adjusting the Exterior Mirrors	115
Locking the Steering Wheel	100	Folding the Exterior Mirrors - Vehicles With: Manual Fold Exterior Mirrors	115
		Folding the Exterior Mirrors - Vehicles With: Power Fold Exterior Mirrors	115
Wipers and Washers		Instrument Cluster	
Wipers	101	Instrument Cluster Overview - Gasoline	117
Autowipers	101	Instrument Cluster Overview - Battery Electric Vehicle	118
Checking the Wiper Blades	102	Tachometer - Gasoline	118
Replacing the Front Wiper Blades	102	Power Gauge - Battery Electric Vehicle	118
Washers	102	Speedometer	119
Wipers and Washers – Troubleshooting	103	Fuel Gauge - Gasoline	119
		Vehicle Range Display - Battery Electric Vehicle	119
Exterior Lighting		High Voltage Battery Gauge - Battery Electric Vehicle	120
Exterior Lighting Control	104	Engine Coolant Temperature Gauge - Gasoline	120
Headlamps	104	What Are the Instrument Cluster Warning Lamps	120
Headlamps – Troubleshooting	105	Instrument Cluster Warning Lamps	120
Autolamps	105		
Exterior Lamps	106		
Automatic High Beam Control	107		
Automatic High Beam Control – Troubleshooting	109		
Interior Lighting			
Switching All of the Interior Lamps On and Off	110		
Interior Lamp Function	110		

Table of Contents

What Are the Instrument Cluster Indicators	123
Instrument Cluster Indicators	123

Instrument Cluster Display - Gasoline

Using the Instrument Cluster Display Controls	125
Instrument Cluster Display Main Menu	125
Customizing the Instrument Cluster Display	125
Personalized Settings	125
Fuel Economy Display	126

Instrument Cluster Display - Battery Electric Vehicle

Using the Instrument Cluster Display Controls	127
Instrument Cluster Display Main Menu	127
Customizing the Instrument Cluster Display	127
Personalized Settings	127
Trip Summary	128
Vehicle Charging Status	128

Trip Computer

Accessing the Trip Computer	129
Resetting the Trip Computer	129
Resetting the Individual Trip Values	129
Configuring the Trip Computer	129
Trip Data	129

Remote Start

What Is Remote Start	130
Remote Start Limitations - Gasoline	130
Remote Start Limitations - Battery Electric Vehicle	130
Enabling Remote Start	130

Remotely Starting and Stopping the Vehicle - Gasoline	130
Remotely Starting and Stopping the Vehicle - Battery Electric Vehicle	131
Extending the Remote Start Duration	131
Remote Start Settings	131

Climate Control - Vehicles With: Automatic Temperature Control

Switching Climate Control On and Off	133
Switching Recirculated Air On and Off	133
Switching Air Conditioning On and Off	133
Switching Defrost On and Off	133
Switching Maximum Defrost On and Off	133
Switching Maximum Cooling On and Off	134
Switching the Electric Heater On and Off - Battery Electric Vehicle	134
Switching the Heated Rear Window On and Off	134
Setting the Blower Motor Speed	134
Switching the Heated Mirrors On and Off - Vehicles Without: Heated Rear Window	134
Switching the Heated Mirrors On and Off - Vehicles With: Heated Rear Window	135
Setting the Temperature	135
Directing the Flow of Air	135
Auto Mode	135
Climate Control Hints - Gasoline	136
Climate Control Hints - Battery Electric Vehicle	137

Table of Contents

Climate Control - Vehicles With: Manual Temperature Control

Switching Climate Control On and Off	139
Switching Recirculated Air On and Off	139
Switching Air Conditioning On and Off	139
Switching Defrost On and Off	139
Switching Maximum Defrost On and Off	139
Switching Maximum Cooling On and Off	139
Switching the Heated Rear Window On and Off	140
Setting the Blower Motor Speed	140
Switching the Heated Mirrors On and Off - Vehicles Without: Heated Rear Window	140
Switching the Heated Mirrors On and Off - Vehicles With: Heated Rear Window	140
Setting the Temperature	140
Directing the Flow of Air	141
Climate Control Hints	141

Rear Passenger Climate Control

Setting the Blower Motor Speed	143
Directing the Flow of Air	143

Front Seats

Front Seat Precautions	144
Sitting in the Correct Position	144
Manual Seats	145
Power Seats	148
Heated Seats	151

Rear Seats

Rear Seat Precautions	152
Manual Seats	152

Rear Occupant Alert System

What is the Rear Occupant Alert System	156
How Does the Rear Occupant Alert System Work	156
Rear Occupant Alert System Precautions	156
Rear Occupant Alert System Limitations	156
Switching Rear Occupant Alert System On and Off	156
Rear Occupant Alert System Indicators	157
Rear Occupant Alert System Audible Warnings	157

USB Ports

Locating the USB Ports	158
Playing Media Using the USB Port - Vehicles With: SYNC 4	158
Charging a Device	159

Power Outlet - Vehicles With: 110-120V Power Outlet

What Is the Power Outlet	160
Power Outlet Precautions	160
Power Outlet Limitations	160
Locating the Power Outlets	160
Power Outlet Indicators	160

Power Outlet - Vehicles With: 110-120V 2.4kW Power Outlet

What Is the Power Outlet	162
Power Outlet Precautions	162
Locating the Power Outlets	162
Power Outlet Indicators	163
Switching the Rear Power Outlet On and Off	163
Setting the High Voltage Battery Reserve Limit	164

Table of Contents

Resetting Ground Fault Detection	164
Power Outlet – Troubleshooting	165

Power Outlet - Vehicles With: 12V Power Outlet

What Is the Power Outlet	167
Power Outlet Precautions	167
Locating the Power Outlets	167

Cigar Lighter

Cigar Lighter Precautions	168
Using the Cigar Lighter	168

Storage

Bottle Holders	169
Overhead Storage	169

Starting and Stopping the Engine - Gasoline

Starting and Stopping the Engine – Precautions	170
Ignition Switch	170
Push Button Ignition Switch	171
Starting the Engine	171
Engine Block Heater	173
Stopping the Engine	174
Automatic Engine Stop - Vehicles With: Push Button Start	175
Accessing the Passive Key Backup Position	176
Starting and Stopping the Engine – Troubleshooting	176

Starting and Powering Off - Battery Electric Vehicle

Starting and Powering Off Precautions	180
Starting the Vehicle	180
Powering Off	180
Restarting the Vehicle After Powering Off	180

Vehicle Power Down Timer	181
Accessing the Passive Key Backup Position	181
Starting and Powering Off – Troubleshooting	182

Fuel and Refueling

Fuel and Refueling Precautions	183
Fuel Quality	184
Locating the Fuel Filler Funnel	186
Running Out of Fuel	186
Refueling	187
Fuel Tank Capacity - 3.5L Duratec	189
Fuel Tank Capacity - 3.5L EcoBoost™	189
Fuel and Refueling – Troubleshooting	189

Catalytic Converter

What Is the Catalytic Converter	190
Catalytic Converter Precautions	190
Catalytic Converter – Troubleshooting	190

High Voltage Battery - Battery Electric Vehicle

What Is the High Voltage Battery	191
High Voltage Battery Precautions	191
Preserving Your High Voltage Battery	191
Recycling and Disposing of the High Voltage Battery	192
High Voltage Battery – Troubleshooting	192

Charging Your Vehicle - Battery Electric Vehicle

What is AC Charging	193
What is DC Charging	193
Charging Your Vehicle Precautions	193
Charging Equipment	193

Table of Contents

Locating the Charge Port	201
Charge Port Indicators	201
AC Charging	202
Charge Coupler Manual Release	205
Using Your Vehicle App and Charging	206
DC Charging	206
Setting the Charging Schedule and Preferences	208
Using FordPass and Charging	213
Charging Your Vehicle Hints	213
Charging Your Vehicle – Troubleshooting	214

Automatic Transmission

Automatic Transmission Precautions	216
Automatic Transmission Positions	216
Shifting Your Vehicle Into Gear - 1-Speed Automatic Transmission	217
Automatic Transmission Position Indicators - 1-Speed Automatic Transmission	217
Automatic Transmission Position Indicators - 10-Speed Automatic Transmission	218
Shifting Your Immobile Vehicle Out of Park (P) - 1-Speed Automatic Transmission	218
Shifting Your Immobile Vehicle Out of Park (P) - 10-Speed Automatic Transmission	219
Automatic Transmission Audible Warnings - 1-Speed Automatic Transmission	220
Automatic Transmission Audible Warnings - 10-Speed Automatic Transmission	220
Using Progressive Range Selection - 10-Speed Automatic Transmission	220
Manually Shifting Gears - 10-Speed Automatic Transmission	221
Temporary Neutral Mode - 1-Speed Automatic Transmission	221

Automatic Return to Park (P) - 1-Speed Automatic Transmission	222
Automatic Transmission – Troubleshooting	223

All-Wheel Drive

How Does All-Wheel Drive Work	224
All-Wheel Drive Precautions	224
All-Wheel Drive Limitations	224
All-Wheel Drive – Troubleshooting	224

Brakes

Brake Precautions	225
Anti-Lock Braking System	225
Brake Over Accelerator	225
Locating the Brake Fluid Reservoir	225
Checking the Brake Fluid	225
Brake Fluid Specification	226
Brakes – Troubleshooting	226

Parking Brake - Vehicles With: Conventional Mechanical Parking Brake

Applying the Parking Brake	228
Releasing the Parking Brake	228
Parking Brake Audible Warning	228
Parking Brake – Troubleshooting	228

Parking Brake - Vehicles With: Push Down Parking Brake

Applying the Parking Brake	229
Releasing the Parking Brake	229
Pushing the Parking Brake Lever Down	229
Parking Brake Audible Warning	229
Parking Brake – Troubleshooting	230

Electric Parking Brake

What Is the Electric Parking Brake	231
Applying the Electric Parking Brake	231

Table of Contents

Applying the Electric Parking Brake in an Emergency	231
Manually Releasing the Electric Parking Brake	231
Automatically Releasing the Electric Parking Brake	231
Electric Parking Brake Audible Warning	232
Releasing the Electric Parking Brake if the Vehicle Battery Has Run Out of Charge	232
Electric Parking Brake – Troubleshooting	232

Reverse Brake Assist

What Is Reverse Brake Assist	234
How Does Reverse Brake Assist Work	234
Reverse Brake Assist Precautions	234
Switching Reverse Brake Assist On and Off	235
Overriding Reverse Brake Assist	235
Reverse Brake Assist Indicators	235
Reverse Brake Assist – Troubleshooting	236

Hill Start Assist

What Is Hill Start Assist	238
How Does Hill Start Assist Work	238
Hill Start Assist Precautions	238
Hill Start Assist – Troubleshooting	238

Auto Hold

How Does Auto Hold Work	239
Switching Auto Hold On and Off	239
Using Auto Hold	239
Auto Hold Indicators	239

Traction Control

What Is Traction Control	241
How Does Traction Control Work	241

Switching Traction Control On and Off - Vehicles With: SYNC 3 Lite, Vehicles Without: SYNC	241
Switching Traction Control On and Off - Vehicles With: SYNC 4	241
Traction Control Indicator	241
Traction Control – Troubleshooting	242

Stability Control

What Is Stability Control	243
How Does Stability Control Work	243
Switching Stability Control On and Off	243
Stability Control Indicator	244

Steering

Electric Power Steering	245
Steering – Troubleshooting	245

Parking Aids

Parking Aid Precautions	246
Switching Parking Aid On and Off - Vehicles With: SYNC 3 Lite, Vehicles Without: SYNC	247
Switching Parking Aid On and Off - Vehicles With: SYNC 4	247
Rear Parking Aid	247
Front Parking Aid	248
Side Parking Aid	249
Parking Aid Indicators	250
Parking Aids – Troubleshooting	250

Rear View Camera

What Is the Rear View Camera	252
Rear View Camera Precautions	252
Rear View Camera Limitations	252
Locating the Rear View Camera	253
Rear View Camera Guide Lines	253
Rear View Camera Settings	254

Table of Contents

180 Degree Camera

What Is the 180 Degree Camera	256
How Does the 180 Degree Camera Work	256
180 Degree Camera Precautions	256
Switching the 180 Degree Camera On and Off	256

360 Degree Camera

What Is the 360 Degree Camera	257
How Does the 360 Degree Camera Work	257
360 Degree Camera Precautions	257
360 Degree Camera Limitations	257
Locating the 360 Degree Cameras	257
360 Degree Camera Guide Lines	258
Switching the 360 Degree Camera On and Off	259
Switching the 360 Degree Camera View	259

Active Park Assist

What Is Active Park Assist	260
Active Park Assist Precautions	260
Switching Active Park Assist On and Off - Vehicles With: SYNC 3 Lite, Vehicles Without: SYNC	260
Switching Active Park Assist On and Off - Vehicles With: SYNC 4	260
Entering a Parking Space	261
Exiting a Parking Space	261
Active Park Assist – Troubleshooting	261

Cruise Control

What Is Cruise Control	263
Switching Cruise Control On and Off	263
Setting the Cruise Control Speed	263
Canceling the Set Speed	263
Resuming the Set Speed	264
Cruise Control Indicators	264

Adaptive Cruise Control

How Does Adaptive Cruise Control Work	265
Adaptive Cruise Control Precautions	265
Adaptive Cruise Control Limitations	266
Switching Adaptive Cruise Control On and Off	268
Adaptive Cruise Control Automatic Cancellation	268
Setting the Adaptive Cruise Control Speed	268
Setting the Adaptive Cruise Control Gap	269
Canceling the Set Speed	270
Resuming the Set Speed	270
Overriding the Set Speed	270
Adaptive Cruise Control Indicators	270
Switching From Adaptive Cruise Control to Cruise Control	270
Intelligent Adaptive Cruise Control	271
Adaptive Cruise Control – Troubleshooting	272

Drive Mode Control

What Is Drive Mode Control	275
Selecting a Drive Mode - Vehicles With: SYNC 3 Lite, Vehicles Without: SYNC	275
Selecting a Drive Mode - Vehicles With: SYNC 4	275
Drive Modes - Gasoline	275
Drive Modes - Battery Electric Vehicle	276
Drive Mode Control – Troubleshooting	276

Eco Coach

What Is Eco Coach	277
How Does Eco Coach Work	277
How Does Instantaneous Efficiency Level Work	277

Table of Contents

Viewing the Instantaneous Efficiency Level	277
How Does Trip Summary Work	277
Viewing the Trip Summary	277

Speed Limiter

How Does the Speed Limiter Work	278
Speed Limiter Precautions	278
Switching the Speed Limiter On and Off	278
Setting the Speed Limit	278
Changing the Set Speed Limit	278
Canceling the Set Speed Limit	278
Resuming the Set Speed Limit	278
Intentionally Exceeding the Set Speed Limit	279
Speed Limiter Indicators	279
Speed Limiter Audible Warnings	279

Intelligent Speed Limiter

What Is the Intelligent Speed Limiter	280
How Does the Intelligent Speed Limiter Work	280
Intelligent Speed Limiter Precautions	280
Switching the Intelligent Speed Limiter On and Off	280
Setting the Speed Limit	280
Changing the Set Speed Limit	281
Adjusting the Speed Limit Tolerance	281
Canceling the Set Speed Limit	281
Resuming the Set Speed Limit	281
Intentionally Exceeding the Set Speed Limit	281
Intelligent Speed Limiter Indicators	281
Intelligent Speed Limiter Audible Warnings	282
Switching From Intelligent Speed Limiter to Speed Limiter	282

Intelligent Speed Limiter – Troubleshooting	282
---	-----

Lane Keeping System

What Is the Lane Keeping System	283
How Does the Lane Keeping System Work	283
Lane Keeping System Precautions	283
Lane Keeping System Limitations	284
Switching the Lane Keeping System On and Off	284
Switching the Lane Keeping System Mode	284
Lane Keeping System Settings	284
Alert Mode	285
Aid Mode	285
Alert and Aid Mode	286
Lane Keeping System Indicators	286
Blind Spot Assist - Vehicles With: Blind Spot Information System, Vehicles Without: Trailer Tow	286
Blind Spot Assist with Trailer Coverage - Vehicles With: Blind Spot Information System/Trailer Tow	288
Lane Keeping System – Troubleshooting	291

Blind Spot Information System

What Is Blind Spot Information System	292
How Does Blind Spot Information System Work	292
Blind Spot Information System Precautions	292
Blind Spot Information System Limitations	292
Blind Spot Information System Requirements	293
Switching Blind Spot Information System On and Off	293
Locating the Blind Spot Information System Sensors	293

Table of Contents

Blind Spot Information System With Trailer Coverage	294
Blind Spot Information System Indicators	295
Blind Spot Information System – Troubleshooting	295

Cross Traffic Alert

What Is Cross Traffic Alert	297
How Does Cross Traffic Alert Work	297
Cross Traffic Alert Precautions	297
Cross Traffic Alert Limitations	297
Switching Cross Traffic Alert On and Off	298
Locating the Cross Traffic Alert Sensors	298
Cross Traffic Alert With Trailer Coverage	298
Cross Traffic Alert Indicators	299
Cross Traffic Alert – Troubleshooting	299

Pre-Collision Assist

What Is Pre-Collision Assist	300
How Does Pre-Collision Assist Work	300
How Does Pre-Collision Assist with Intersection Assist Work	301
Pre-Collision Assist Precautions	301
Pre-Collision Assist Limitations	301
Locating the Pre-Collision Assist Sensors - Vehicles Without: Adaptive Cruise Control	302
Locating the Pre-Collision Assist Sensors - Vehicles With: Adaptive Cruise Control	302
Distance Indication	303
Forward Collision Warning	303
Distance Alert	304
Automatic Emergency Braking	304
Pre-Collision Assist – Troubleshooting	304

Speed Sign Recognition

What Is Speed Sign Recognition	306
How Does Speed Sign Recognition Work	306
Speed Sign Recognition Precautions	306
Speed Sign Recognition Limitations	306
Speed Sign Recognition Indicators	306
Setting the Speed Sign Recognition Speed Warning	307
Setting the Speed Sign Recognition Speed Tolerance	307
Speed Sign Recognition – Troubleshooting	307

Driver Alert

What Is Driver Alert	308
How Does Driver Alert Work	308
Driver Alert Precautions	308
Switching Driver Alert On and Off	308
Resetting Driver Alert	308
Driver Alert – Troubleshooting	309

Load Carrying

Load Carrying Precautions	310
Locating the Safety Compliance Certification Labels	311
What Is the Gross Axle Weight Rating	311
What Is the Gross Vehicle Weight Rating	311
What Is the Gross Combined Weight Rating	311
Calculating Payload	312
Calculating the Load Limit	312
Roof Rack	314

Rear Cargo Area

Rear Cargo Area Anchor Points	315
-------------------------------------	-----

Table of Contents

Connecting a Trailer

Connecting a Trailer Precautions	316
Connecting a Trailer	316
Connecting a Trailer – Troubleshooting	318

Towing a Trailer

Towing a Trailer Precautions - Gasoline	319
Towing a Trailer Precautions - Battery Electric Vehicle	319
Trailer Brake Precautions - Gasoline	319
Towing a Trailer Limitations - Gasoline	320
Loading Your Trailer - Gasoline	320
Trailer Towing Hints - Gasoline	320
Launching or Retrieving a Boat or Personal Watercraft - Gasoline	321
Towing Weights and Dimensions	322

Integrated Trailer Brake Controller

What Is the Integrated Trailer Brake Controller	324
Integrated Trailer Brake Controller Precautions	324
Using the Integrated Trailer Brake Controller	324
Adjusting the Integrated Trailer Brake Controller Mode	325
Integrated Trailer Brake Controller – Troubleshooting	326

Trailer Sway Control

How Does Trailer Sway Control Work	328
Trailer Sway Control Precautions	328

Driving Hints

Off-Road Driving - Vehicles With: Trail Package	329
---	-----

Cold Weather Precautions	330
Driving on Snow and Ice	330
Breaking-In	331
Driving Economically	331
Driving in Special Conditions	331
Driving Through Shallow Water - Gasoline	332
Driving Through Shallow Water - Battery Electric Vehicle	333
Electric Vehicle	333
Floor Mats	334

Crash and Breakdown Information

Roadside Assistance - Gasoline	335
Roadside Assistance - Battery Electric Vehicle	336
High Voltage Battery Vehicle Precautions - Battery Electric Vehicle	338
Switching the Hazard Flashers On and Off	339
Jump Starting the Vehicle	339
Post-Crash Alert System	342
Post-Collision Braking	342
Automatic Crash Shutoff	342
Recovery Towing	343
Transporting the Vehicle	344
Fail-Safe Cooling - 3.5L Duratec/3.5L EcoBoost™	344

Towing Your Vehicle

Towing Your Vehicle Precautions	346
Emergency Towing - Battery Electric Vehicle	346

Emergency Equipment

Storing a First Aid Kit	347
Storing a Warning Triangle	347

Fuses

Fuse Precautions	348
------------------------	-----

Table of Contents

Under Hood Fuse Box	348
Interior Fuse Box	353
Body Control Module Fuse Box	359
High Current Fuse Box	362
Identifying Fuse Types	364
Fuses – Troubleshooting	364

Maintenance

Maintenance Precautions	365
Opening and Closing the Hood	365
Under Hood Overview - 3.5L Duratec	367
Under Hood Overview - 3.5L Ecoboost™	368
Under Hood Overview - Battery Electric Vehicle	369
Engine Oil - Gasoline	370
Engine Air Filter - Gasoline	372
Engine Cooling Fan - Gasoline	373
Coolant - Gasoline	373
Coolant - Battery Electric Vehicle	377
12V Battery	380
12V Battery – Troubleshooting - Gasoline	384
12V Battery – Troubleshooting - Battery Electric Vehicle	385
Adjusting the Headlamps	386
Exterior Bulbs	388
Interior Bulbs	399
Fuel Filter - Gasoline	401
Drive Belt Routing - Gasoline, Vehicles With: Dual Generators	402
Drive Belt Routing - Gasoline, Vehicles With: Single Generator	402

Vehicle Care

Cleaning the Exterior	403
Cleaning the Interior	405
Repairing Minor Paint Damage	407
Waxing Your Vehicle	407

Storing Your Vehicle

Preparing Your Vehicle for Storage	408
Removing Your Vehicle From Storage	409

Wheel and Tire Information

Locating the Tire label	410
Department of Transportation Uniform Tire Quality Grades	410
Information on the Tire Sidewall	411
Glossary of Tire Terminology	416
Tire Replacement Requirements	417
Using Winter Tires	419
Using Snow Chains	419

Tire Care

Checking the Tire Pressures	421
Inflating the Tires	421
Inspecting the Tire for Wear	422
Inspecting the Tire for Damage	423
Inspecting the Wheel Valve Stems	427
Tire Rotation	427

Tire Pressure Monitoring System

What Is the Tire Pressure Monitoring System	429
Tire Pressure Monitoring System Overview	429
Tire Pressure Monitoring System Precautions	430
Tire Pressure Monitoring System Limitations	430
Viewing the Tire Pressures	431
Resetting Tire Pressure Monitoring System	431
Tire Pressure Monitoring System – Troubleshooting	432

Changing a Road Wheel

Changing a Flat Tire - Gasoline	434
---------------------------------------	-----

Table of Contents

Changing a Flat Tire - Battery Electric Vehicle	444
Wheel Nuts	451

Capacities and Specifications

Engine Specifications - 3.5L Duratec	452
Engine Specifications - 3.5L EcoBoost™	453
Motorcraft Parts - 3.5L Duratec	454
Motorcraft Parts - 3.5L EcoBoost™	455
Motorcraft Parts - Battery Electric Vehicle	456
Engine Oil Capacity and Specification - 3.5L Duratec	457
Engine Oil Capacity and Specification - 3.5L EcoBoost™	458
Cooling System Capacity and Specification - 3.5L Duratec	460
Cooling System Capacity and Specification - 3.5L EcoBoost™	461
Cooling System Capacity and Specification - Battery Electric Vehicle	461
Fuel Tank Capacity - 3.5L Duratec	463
Fuel Tank Capacity - 3.5L EcoBoost™	464
Air Conditioning System Capacity and Specification - Gasoline	465
Air Conditioning System Capacity and Specification - Battery Electric Vehicle, Vehicles With: Standard Range Battery	466
Air Conditioning System Capacity and Specification - Vehicles Built From: 03/2024, Battery Electric Vehicle, Vehicles With: Extended Range Battery	467
Washer Fluid Specification	467
Brake Fluid Specification	468
Rear Axle Fluid Capacity and Specification - Gasoline	468

Vehicle Identification

Vehicle Identification Number	470
-------------------------------------	-----

Connected Vehicle

What Is a Connected Vehicle - Gasoline	471
What Is a Connected Vehicle - Battery Electric Vehicle	471
Connected Vehicle Requirements	471
Connected Vehicle Limitations	471
Connecting the Vehicle to a Mobile Network	471
Connecting the Vehicle to a Wi-Fi Network - Vehicles With: SYNC 4	472
Connecting the Vehicle to a Wi-Fi Network - Vehicles With: SYNC 3 Lite	472
Connected Vehicle – Troubleshooting	472

Vehicle Wi-Fi Hotspot

Creating a Vehicle Wi-Fi Hotspot - Vehicles With: SYNC 4	475
Changing the Vehicle Wi-Fi Hotspot Name or Password - Vehicles With: SYNC 4	475
Vehicle Wi-Fi Hotspot – Troubleshooting	476

Audio System

Audio System Precautions	477
Switching the Audio Unit On and Off	477
Selecting the Audio Source - Vehicles Without: SYNC	477
Selecting the Audio Source - Vehicles With: SYNC 4	477
Selecting the Audio Source - Vehicles With: SYNC 3 Lite	477
Playing or Pausing the Audio Source	477
Adjusting the Volume	478
Setting a Memory Preset	478

Table of Contents

Muting the Audio	478	Status Bar	501
Scrolling Through Menu Items - Vehicles With: SYNC 3 Lite, Vehicles Without: SYNC	478	Information On Demand Screen	502
Scrolling Through Menu Items - Vehicles With: SYNC 4	478	Rebooting the Center Display	502
Selecting a Menu Item - Vehicles With: SYNC 3 Lite, Vehicles Without: SYNC	479	Voice Interaction	
Selecting a Menu Item - Vehicles With: SYNC 4	479	What is Voice Interaction	503
Adjusting the Sound Settings - Vehicles With: SYNC 3 Lite, Vehicles Without: SYNC	479	Setting the Wake Word	503
Adjusting the Sound Settings - Vehicles With: SYNC 4	479	Beginning a Voice Interaction	503
Setting the Clock and Date - Vehicles Without: SYNC	479	Voice Interaction Examples	503
Setting the Clock and Date - Vehicles With: SYNC 4	479	Alexa Built-In	
Setting the Clock and Date - Vehicles With: SYNC 3 Lite	480	What is Alexa Built-In	505
AM/FM Radio	480	Alexa Built-In Requirements	505
Switching the Display On and Off - Vehicles With: SYNC 3 Lite, Vehicles Without: SYNC	481	Signing In to Your Account	505
Switching the Display On and Off - Vehicles With: SYNC 4	481	Using Alexa Built-In	505
Digital Radio	481	Alexa Built-In Settings	505
Satellite Radio	483	Phone	
SYNC™		Phone Precautions	507
General Information	485	Connecting Your Phone	507
Using Voice Recognition	486	Phone Menu	507
Using SYNC™ With Your Phone	488	Making and Receiving a Phone Call	509
SYNC™ Applications and Services	489	Switching Text Message Notification On and Off	510
Using SYNC™ With Your Media Player	491	Bluetooth®	
SYNC™ Troubleshooting	491	Connecting a Bluetooth® Device	511
Center Display Overview		Playing Media Using Bluetooth®	511
Center Display Precautions	501	Apps	
Center Display Limitations	501	App Precautions	512
		App Requirements	512
		Enabling Apps on an iOS Device	512
		Enabling Apps on an Android Device	512
		Switching Apple CarPlay On and Off	512
		Switching Android Auto On and Off	513

Table of Contents

Navigation

Connected Navigation	514
Accessing Navigation	514
Navigation Map Updates	514
Adjusting the Map	514
Live Traffic	514
Setting a Destination	514
Waypoints	515
Route Guidance	515
Trailer Towing Navigation	516

Driver Identification

How Does Driver Identification Work	517
Signing In as a Driver	517
Driver Identification – Troubleshooting	517

Vehicle Software Updates

Vehicle Software Updates	518
Software Update Settings	518
Software Update Indicators	519

Vehicle System Reset

Performing a System Reset	520
---------------------------------	-----

Accessories

Accessories	521
-------------------	-----

Ford Protect

What Is Ford Protect	522
----------------------------	-----

Scheduled Maintenance

General Maintenance Information - Gasoline	524
General Maintenance Information - Battery Electric Vehicle	527
Normal Scheduled Maintenance - Gasoline	530
Normal Scheduled Maintenance - Battery Electric Vehicle	533

Special Operating Conditions Scheduled Maintenance	535
--	-----

Customer Information

Rollover Warning	538
The Better Business Bureau Auto Line Program	538
The Mediation and Arbitration Program	539
Ordering a Canadian French Owner's Manual	539
Reporting Safety Defects in the United States	540
Reporting Safety Defects in Canada	540
Third Party Software Copyright Acknowledgment	541
Radio Frequency Certification Labels	541
Perchlorate	576
Replacement Parts Recommendation	576
Mobile Communications Equipment	576
End User License Agreement	577
Emission Law	602
Export Unique Options	603
Warranty Information	604

Appendices

Electromagnetic Compatibility	606
-------------------------------------	-----

Contacting Us

If you require assistance or clarification on policies or procedures, please contact the customer relationship center.

United States

Ford Motor Company
Customer Relationship Center
PO Box 6248
Dearborn, MI 48126
1-800-392-3673 (FORD)
TDD for the hearing impaired:
7-1-1 (where offered by your telephone
service provider)
www.ford.com/help/contact/

Ford Credit - US Only

Ford Credit offers a full range of financing and lease plans to help you acquire your vehicle. If you have financed or leased your vehicle through Ford Credit, thank you for your business.

For assistance call 1-800-727-7000, or for more information about Ford Credit and access to an account manager, visit www.ford.com/finance.

Canada

Customer Relationship Centre
Ford Motor Company of Canada Limited
P.O. Box 2000
Oakville, Ontario L6J 5E4
1-800-565-3673 (FORD)
TDD for the hearing impaired:
7-1-1 (where offered by your telephone
service provider)
www.ford.ca

Australia

Ford Motor Company of Australia Pty Ltd.
Customer Relationship Centre
Private Mail Bag 5
Campbellfield, Victoria, 3061
Telephone: (13 FORD) 13 3673
E-mail: foacust1@ford.com

New Zealand

Ford Motor Company
Attention: Customer Relationship Centre
Private Bag 76912
Manukau City 2241
Telephone: 0800 367 369 (FORDNZ)
E-mail: fnzcust@ford.com

China - Imported Vehicle

Customer Relationship Center
Telephone: 400-690-1886
Website: <https://www.ford.com.cn/>

China - Chang'An Ford

Customer Relationship Center
Telephone: 800-810-8168
Mobile: 400-887-7766
Website: <https://www.ford.com.cn/>

Asia Pacific Direct Markets (APDM)

E-mail: apemcrc@ford.com

Caribbean, Central America and Israel

Ford Motor Company
Ford Export Operations
Attention: Owner Relations
1555 Fairlane Drive
Fairlane Business Park #3
Allen Park, MI 48101
Fax: (313) 390-0804
Telephone: (313) 594-4857
E-mail: expcac@ford.com

U.S. Virgin Islands and Puerto Rico

Ford Motor Company
Ford Export Operations
Attention: Owner Relations
1555 Fairlane Drive
Fairlane Business Park #3
Allen Park, MI 48101
Telephone: (800) 841-3673
E-mail: prcac@ford.com

Contacting Us

Argentina

Telephone: 0800-888-3673

Brazil

Website: www.ford.com.br
Telephone: 0800-703-3673
E-mail: central@ford.com

North Africa

E-mail: nafcrc@ford.com

South Africa

Telephone: 0860011022
Email: fordcrc2@ford.com

Sub-Saharan Africa

E-mail: ssacrc@ford.com

Puerto Rico

Ford International Business Development,
Inc.
P.O. Box 11957
Caparra Heights Station
San Juan, PR 00922-1957
1-800-392-3673 (FORD)
Fax: (313) 390-0804
E-mail: prcac@ford.com
www.ford.com.pr

Middle East

Ford Middle East Customer Relationship
Center
P.O. Box 21740
Dubai, United Arab Emirates
Telephone: 80004441066
Toll-free number for the Kingdom of Saudi
Arabia: 8008443673
Mobily and Zain cell phone users in Saudi
Arabia: 800850078
Kuwait: 22280384
Local telephone number for Kuwait: +965
1 898900
Fax: +971 4 3327266
E-mail: menacac@ford.com
www.me.ford.com

South Korea

Customer Relationship Center
Telephone: +82-02-1600-6003
E-mail: infokr1@ford.com
Emergency Dispatch Service call:
080-300-3673

Philippines

Telephone: 02-88669408
Email: emailus@ford.com

Taiwan

Telephone: 0800-032100
705 Zhonghua Rd., Sec. 1
Zhongli District, Taoyuan, Taiwan, 32068

Thailand

Telephone: 1383
E-mail: fordthai@ford.com

Vietnam

Telephone: 1800588888
E-mail: fordvn@ford.com

Introduction

ABOUT THIS PUBLICATION



WARNING: Driving while distracted can result in loss of vehicle control, crash and injury. We strongly recommend that you use extreme caution when using any device that may take your focus off the road. Your primary responsibility is the safe operation of your vehicle. We recommend against the use of any hand-held device while driving and encourage the use of voice-operated systems when possible. Make sure you are aware of all applicable local laws that may affect the use of electronic devices while driving.

Thank you for choosing Ford. We recommend that you take some time to get to know your vehicle by reading this publication. The more that you know about your vehicle, the greater the safety and pleasure you will get from driving it.

Note: Use and operate your vehicle in line with all applicable laws and regulations.

Note: Pass on all printed owner's information when selling this vehicle.

Features and Options

Note: This publication describes product features and options available throughout the range of available models, sometimes even before they are generally available. It could describe options that are not available on the vehicle you have purchased.

Illustrations

Note: Some of the illustrations in this publication could show features as used in different models, so could appear different to you on your vehicle.

Location of Components

This publication could qualify the location of a component as left-hand side or right-hand side. The side is determined when facing forward in the seat.

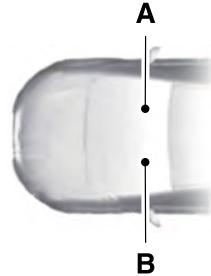

A Right-hand side.

B Left-hand side.

USING THIS PUBLICATION

To quickly locate information about your vehicle, use the word search within the Owner's Manual application.

WARNINGS AND NOTES USED IN THIS PUBLICATION

Warnings Used in This Publication

We include warnings in this publication to make you aware of possible danger. You can keep yourself and others safe if you follow the instructions highlighted by the warning symbol.





























Notes Used in This Publication

We include notes to give you more information to those instructions that require further explanation.

Symbols Glossary

SYMBOLS USED ON YOUR VEHICLE

These are some of the symbols you may see on your vehicle.

	Airbag		Child safety door lock or unlock
	Air conditioning system		Child seat lower anchor
	Air conditioning system lubricant type		Child seat tether anchor
	Anti-lock braking system		Cruise control
	Avoid smoking, flames or sparks		Do not open when hot
	Battery		Electric Parking brake
	Battery acid		Engine air filter
	Blower motor		Engine coolant
	Brake fluid - non petroleum based		Engine coolant temperature
	Brake system		Engine oil
	Brake system		Explosive gas
	Cabin air filter		Fan warning
	Check fuel cap		Fasten seatbelt
			Flammable
			Front fog lamps
			Front fog lamps

Symbols Glossary



Fuel pump reset



Fuse compartment



Hazard flashers



Headlamp high beams



Headlamps on



Heated rear window



Hill descent control



Horn control



Interior luggage compartment release



Jack



Keep out of reach of children



Lighting control



Low fuel level



Low tire pressure warning



Maintain correct fluid level



Malfunction Indicator Lamp (MIL)



Note operating instructions



Panic alarm



Parking aid



Parking lamps



Passenger airbag activated



Passenger airbag deactivated



Power steering fluid



Power windows front/rear



Power window lockout



Requires registered technician



Safety alert



See Owner's Manual



See Service Manual



Side airbag

Symbols Glossary



Shield the eyes



Stability control



Stability control off



Trail control



Turn Signal



Windshield defrosting system



Windshield wiping system



Windshield wash and wipe

Data Privacy

DATA PRIVACY - GASOLINE



WARNING: Do not connect wireless plug-in devices to the data link connector. Unauthorized third parties could gain access to vehicle data and impair the performance of safety related systems. Only allow repair facilities that follow our service and repair instructions to connect their equipment to the data link connector.

We respect your privacy and are committed to protecting it. The information contained in this publication was correct at the time of release, but as technology rapidly changes, we recommend that you visit the local Ford website for the latest information.

Your vehicle has electronic control units that have data recording functionality and the ability to permanently or temporarily store data. This data could include information on the condition and status of your vehicle, vehicle maintenance requirements, events and malfunctions. The types of data that can be recorded are described in this section. Some of the data recorded is stored in event logs or error logs.

Note: *Error logs are reset following a service or repair.*

Note: *We may provide information in response to requests from law enforcement, other government authorities and third parties acting with lawful authority or through a legal process. Such information could be used by them in legal proceedings.*

Data recorded includes, for example:

- Operating states of system components, for example fuel level, tire pressure and battery charge level.
- Vehicle and component status, for example wheel speed, deceleration, lateral acceleration and seatbelt status.
- Events or errors in essential systems, for example headlamps and brakes.
- System responses to driving situations, for example airbag deployment and stability control.
- Environmental conditions, for example temperature.

Some of this data, when used in combination with other information, for example an accident report, damage to a vehicle or eyewitness statements, could be associated with a specific person.

Services That We Provide

If you use our services, we collect and use data, for example account information, vehicle location and driving characteristics, that could identify you. We transmit this data through a dedicated, protected connection. We only collect and use data to enable your use of our services to which you have subscribed, with your consent or where permitted by law. For additional information, see the terms and conditions of the services to which you have subscribed.

For additional information about our privacy policy, refer to the local Ford website.

Data Privacy

Services That Third Parties Provide

We recommend that you review the terms and conditions and data privacy information for any services equipped with your vehicle or to which you subscribe. We take no responsibility for services that third parties provide.

Where equipped, SiriusXM with 360L could use the modem. To disable, turn off the SiriusXM with 360L or Vehicle Connectivity setting. See **Enabling and Disabling the Modem** (page 471).

DATA PRIVACY - BATTERY ELECTRIC VEHICLE



WARNING: Do not connect wireless plug-in devices to the data link connector. Unauthorized third parties could gain access to vehicle data and impair the performance of safety related systems. Only allow repair facilities that follow our service and repair instructions to connect their equipment to the data link connector.

We respect your privacy and are committed to protecting it. The information contained in this publication was correct at the time of release, but as technology rapidly changes, we recommend that you visit the local Ford website for the latest information.

Your vehicle has electronic control units that have data recording functionality and the ability to permanently or temporarily store data. This data could include information on the condition and status of your vehicle, vehicle maintenance requirements, events and malfunctions. The types of data that can be recorded are described in this section. Some of the data recorded is stored in event logs or error logs.

Note: *Error logs are reset following a service or repair.*

Note: *We may provide information in response to requests from law enforcement, other government authorities and third parties acting with lawful authority or through a legal process. Such information could be used by them in legal proceedings.*

Data recorded includes, for example:

- Operating states of system components, for example battery charge level and tire pressure.
- Vehicle and component status, for example wheel speed, deceleration, lateral acceleration and seatbelt status.
- Events or errors in essential systems, for example headlamps and brakes.
- System responses to driving situations, for example airbag deployment and stability control.
- Environmental conditions, for example temperature.

Some of this data, when used in combination with other information, for example an accident report, damage to a vehicle or eyewitness statements, could be associated with a specific person.

Data Privacy

Services That We Provide

If you use our services, we collect and use data, for example account information, vehicle location and driving characteristics, that could identify you. We transmit this data through a dedicated, protected connection. We only collect and use data to enable your use of our services to which you have subscribed, with your consent or where permitted by law. For additional information, see the terms and conditions of the services to which you have subscribed.

For additional information about our privacy policy, refer to the local Ford website.

Services That Third Parties Provide

We recommend that you review the terms and conditions and data privacy information for any services equipped with your vehicle or to which you subscribe. We take no responsibility for services that third parties provide.

Where equipped, SiriusXM with 360L could use the modem. To disable, turn off the SiriusXM with 360L or Vehicle Connectivity setting. See **Enabling and Disabling the Modem** (page 471).

SERVICE DATA - GASOLINE

Service data recorders in your vehicle are capable of collecting and storing diagnostic information about your vehicle. This potentially includes information about the performance or status of various systems and modules in the vehicle, such as engine, throttle, steering or brake systems. In order to properly diagnose and service your vehicle, Ford Motor Company (Ford of Canada in Canada), and service and repair facilities may access or share among them vehicle diagnostic

information received through a direct connection to your vehicle when diagnosing or servicing your vehicle. Additionally, Ford Motor Company (Ford of Canada, in Canada) may, where permitted by law, use vehicle diagnostic information for vehicle improvement or with other information we may have about you, for example, your contact information, to offer you products or services that may interest you. Data may be provided to our service providers such as part suppliers that may help diagnose malfunctions, and who are similarly obligated to protect data. We retain this data only as long as necessary to perform these functions or to comply with law. We may provide information where required in response to official requests to law enforcement or other government authorities or third parties acting with lawful authority or court order, and such information may be used in legal proceedings. For U.S. only (if equipped), if you choose to use connected apps and services, you consent that certain diagnostic information may also be accessed electronically by Ford Motor Company and Ford authorized service facilities, and that the diagnostic information may be used to provide services to you, personalizing your experience, troubleshoot, and to improve products and services and offer you products and services that may interest you, where permitted by law. For Canada only, for more information, please review the Ford of Canada privacy policy at www.ford.ca, including our U.S. data storage and use of service providers in other jurisdictions who may be subject to legal requirements in Canada, the United States and other countries applicable to them, for example, lawful requirements to disclose personal information to governmental authorities in those countries.

Data Privacy

SERVICE DATA - BATTERY ELECTRIC VEHICLE

Service data recorders in your vehicle are capable of collecting and storing diagnostic information about your vehicle. This potentially includes information about the performance or status of various systems and modules in the vehicle, such as the high voltage battery, throttle, and steering or brake systems. In order to properly diagnose and service your vehicle, Ford Motor Company (Ford of Canada in Canada), and service and repair facilities may access or share among them vehicle diagnostic information received through a direct connection to your vehicle when diagnosing or servicing your vehicle. Additionally, Ford Motor Company (Ford of Canada, in Canada) may, where permitted by law, use vehicle diagnostic information for vehicle improvement or with other information we may have about you, for example, your contact information, to offer you products or services that may interest you. Data may be provided to our service providers such as part suppliers that may help diagnose malfunctions, and who are similarly obligated to protect data. We retain this data only as long as necessary to perform these functions or to comply with law. We may provide information where required in response to official requests to law enforcement or other government authorities or third parties acting with lawful authority or court order, and such information may be used in legal proceedings. For U.S. only (if equipped), if you choose to use connected apps and services, you consent that certain diagnostic information may also be accessed electronically by Ford Motor Company and Ford authorized service facilities, and that the diagnostic information may be used to provide services to you, personalizing your experience, troubleshoot, and to improve

products and services and offer you products and services that may interest you, where permitted by law. For Canada only, for more information, please review the Ford of Canada privacy policy at www.ford.ca, including our U.S. data storage and use of service providers in other jurisdictions who may be subject to legal requirements in Canada, the United States and other countries applicable to them, for example, lawful requirements to disclose personal information to governmental authorities in those countries.

EVENT DATA

This vehicle is equipped with an event data recorder. The main purpose of an event data recorder is to record, in certain crash or near crash-like situations, such as an airbag deployment or hitting a road obstacle; this data will assist in understanding how a vehicle's systems performed. The event data recorder is designed to record data related to vehicle dynamics and safety systems for a short period of time, typically 30 seconds or less.

The event data recorder in this vehicle is designed to record such data as:

- How various systems in your vehicle were operating.
- Whether or not the driver and passenger seatbelts were buckled/fastened.
- How far (if at all) the driver was depressing the accelerator and/or the brake pedal.
- How fast the vehicle was traveling.
- Where the driver was positioning the steering wheel.

This data can help provide a better understanding of the circumstances in which crashes and injuries occur.

Data Privacy

Note: *Event data recorder data is recorded by your vehicle only if a non-trivial crash situation occurs; no data is recorded by the event data recorder under normal driving conditions and no personal data or information (for example name, gender, age, and crash location) is recorded. However, parties, such as law enforcement, could combine the event data recorder data with the type of personally identifying data routinely acquired during a crash investigation.*

To read data recorded by an event data recorder, special equipment is required, and access to the vehicle or the event data recorder is needed. In addition to the vehicle manufacturer, other parties, such as law enforcement, that have such special equipment, can read the information if they have access to the vehicle or the event data recorder.

SETTINGS DATA

Your vehicle has electronic control units that have the ability to store data based on your personalized settings. The data is stored locally in the vehicle or on devices that you connect to it, for example, a USB drive or digital music player. You can delete some of this data and also choose whether to share it through the services to which you subscribe.

Comfort and Convenience Data

Data recorded includes, for example:

- Seat and steering wheel position.
- Climate control settings.
- Radio presets.

Entertainment Data

Data recorded includes, for example:

- Music, videos or album art.
- Contacts and corresponding address book entries.
- Navigation destinations.

CONNECTED VEHICLE DATA



The modem has a SIM. The modem was enabled when your vehicle was built and periodically sends messages to stay connected to the cell phone network, receive automatic software updates and send vehicle-related information to us, for example diagnostic information. These messages could include information that identifies your vehicle, the SIM and the electronic serial number of the modem. Cell phone network service providers could have access to additional information, for example cell phone network tower identification. For additional information about our privacy policy, visit www.FordConnected.com or refer to your local Ford website.

Note: *The modem continues to send this information unless you disable the modem or stop the modem from sharing vehicle data by changing the modem settings. See **Connecting the Vehicle to a Mobile Network** (page 471).*

Note: *The service can be unavailable or interrupted for a number of reasons, for example environmental or topographical conditions and data plan coverage.*

Note: *To find out if your vehicle has a modem, visit www.FordConnected.com.*

Data Privacy

MOBILE DEVICE DATA - VEHICLES WITH: SYNC 4

If you connect a mobile device to your vehicle, you can display data from your device on the touchscreen for example, music and album art. You can share your vehicle data with mobile apps on your device through the system. See **App Requirements** (page 512).

The mobile apps function operates by your connected device sending data to us in the United States. The data is encrypted and includes, for example, the vehicle identification number of your vehicle, the SYNC module serial number, odometer, enabled apps, usage statistics and debugging information. We retain it only as long as necessary to provide the service, to troubleshoot, for continuous improvement and to offer you products and services that may be of interest to you according to your preferences and where allowed by law.

If you connect a cell phone to the system, the system creates a profile that links to that cell phone. The cell phone profile enables more mobile features and efficient operation. The profile contains, for example data from your phonebook, read and unread text messages and call history, including history of calls when your cell phone was not connected to the system.

If you connect a media device, the system creates and retains a media device index of supported media content. The system also records a short diagnostic log of approximately 10 minutes of all recent system activity.

The cell phone profile, media device index and diagnostic log remain in your vehicle unless you delete them and are generally accessible only in your vehicle when you connect your cell phone or media device. If you no longer plan to use the system or your vehicle, we recommend you use the system reset function to erase the stored information. See **Performing a System Reset** (page 520).

System data cannot be accessed without special equipment and access to your vehicle's module.

For additional information about our privacy policy, refer to the local Ford website.

Note: *To find out if your vehicle has connectivity technology, visit www.FordConnected.com.*

EMERGENCY CALL SYSTEM DATA - GASOLINE

When the emergency call system is active, it may disclose to emergency services that your vehicle has been in a crash involving the deployment of an airbag or activation of the fuel pump shut-off. Certain versions or updates to the emergency call system may also be capable of electronically or verbally disclosing to emergency services operators your vehicle location or other details about your vehicle or crash to assist emergency services operators to provide the most appropriate emergency services. If you do not want to disclose this information, do not activate the emergency call system.

Note: *You cannot deactivate emergency call systems that are required by law.*

EMERGENCY CALL SYSTEM DATA - BATTERY ELECTRIC VEHICLE

When the emergency call system is active, it may disclose to emergency services that your vehicle has been in a crash involving the deployment of an airbag or activation of the battery shut-off. Certain versions or updates to the emergency call system may also be capable of electronically or verbally disclosing to emergency services operators your vehicle location or other details about your vehicle or crash to assist emergency services operators to provide the most appropriate emergency services. If you do not want to disclose this information, do not activate the emergency call system.

Note: *You cannot deactivate emergency call systems that are required by law.*

Environment

PROTECTING THE ENVIRONMENT

Sustainability is a priority at Ford. We are constantly looking for ways to reduce our impact on the planet while providing customers with great products and delivering a strong business. You should play your part in protecting the environment. Correct vehicle usage and the authorized disposal of waste, cleaning and lubrication materials are significant steps toward this aim.

For additional information about our sustainability progress and initiatives, visit www.sustainability.ford.com.

Visual Search

STEERING WHEEL



- A Cruise control buttons. See **Switching Cruise Control On and Off** (page 263).
- B Information display controls. See **Using the Instrument Cluster Display Controls** (page 125). See **Using the Instrument Cluster Display Controls** (page 127).

INSTRUMENT PANEL - VEHICLES WITH: SYNC 4

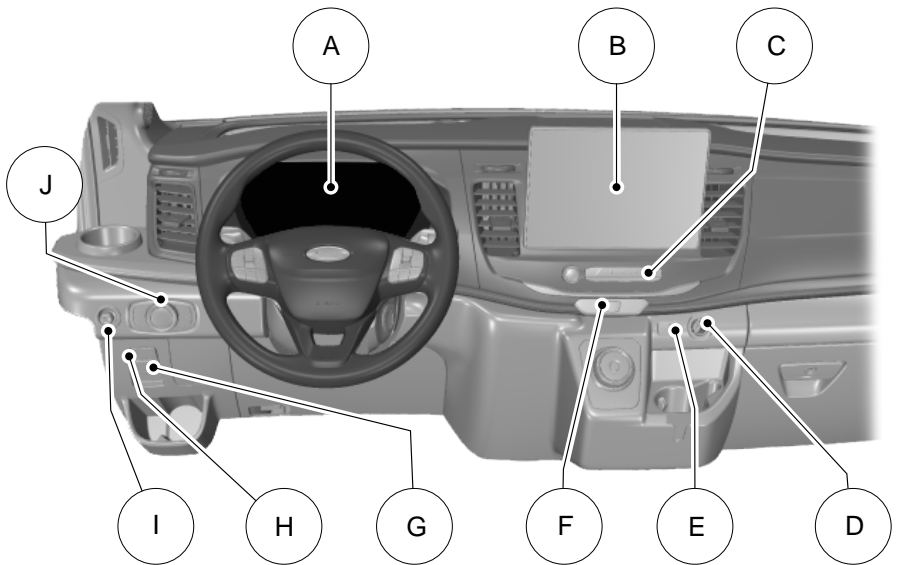

Visual Search

- A See **Instrument Cluster Overview** (page 117). See **Instrument Cluster Overview** (page 118).
- B See **Status Bar** (page 501).
- C See **Selecting a Drive Mode** (page 275).
- D See **Power Outlet Precautions** (page 160).
- E See **Playing Media Using the USB Port** (page 158).
- F See **Switching the Hazard Flashers On and Off** (page 339).
- G See **Applying the Electric Parking Brake** (page 231).
- H See **Switching Auto Hold On and Off** (page 239).
- I See **Adjusting the Exterior Mirrors** (page 115).
- J See **Exterior Lighting Control** (page 104).

INSTRUMENT PANEL - VEHICLES WITH: SYNC 3 LITE, VEHICLES WITHOUT: SYNC

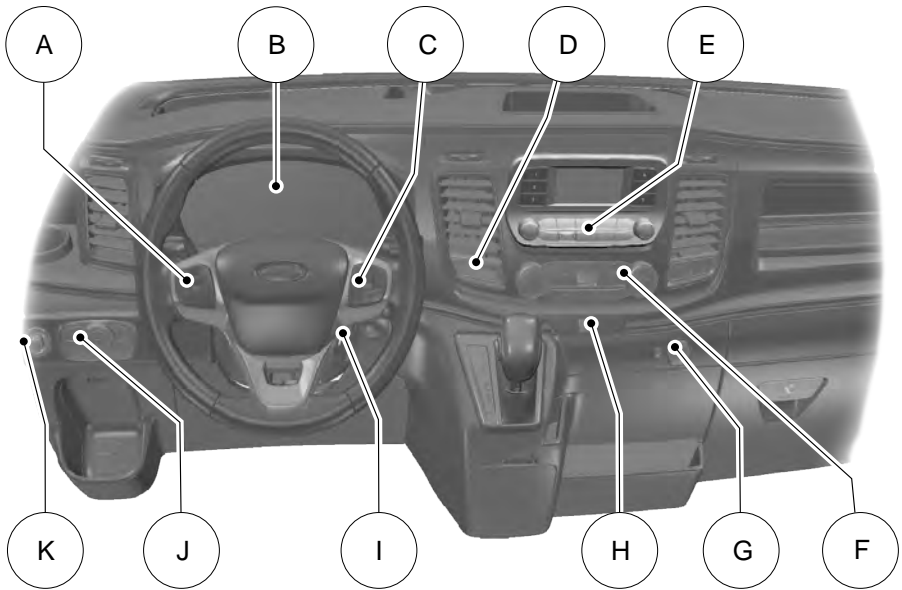

Visual Search

- A See **Switching Cruise Control On and Off** (page 263).
- B See **Instrument Cluster Overview** (page 117).
- C See **Using the Instrument Cluster Display Controls** (page 125).
- D See **Switching Traction Control On and Off** (page 241). See **Selecting a Drive Mode** (page 275).
- E See **Switching the Audio Unit On and Off** (page 477).
- F See **Switching Climate Control On and Off** (page 139).
- G See **Locating the Power Outlets** (page 167).
- H See **Switching the Hazard Flashers On and Off** (page 339).
- I See **Ignition Switch** (page 170).
- J See **Exterior Lighting Control** (page 104).
- K See **Adjusting the Exterior Mirrors** (page 115).

Child Safety

CHILD SAFETY PRECAUTIONS



WARNING: Always make sure your child is secured properly in a device that is appropriate for their height, age and weight. Child safety restraints must be bought separately from your vehicle. Failure to follow these instructions and guidelines may result in an increased risk of serious injury or death to your child.



WARNING: All children are shaped differently. The National Highway Traffic Safety Administration and other safety organizations, base their recommendations for child restraints on probable child height, age and weight thresholds, or on the minimum requirements of the law. We recommend that you check with a NHTSA Certified Child Passenger Safety Technician (CPST) to make sure that you properly install the child restraint in your vehicle and that you consult your pediatrician to make sure you have a child restraint appropriate for your child. To locate a child restraint fitting station and CPST, contact NHTSA toll free at 1-888-327-4236 or go to www.nhtsa.dot.gov. In Canada, contact Transport Canada toll free at 1-800-333-0371 or go to www.tc.gc.ca to find a Child Car Seat Clinic in your area. Failure to properly restrain children in child restraints made especially for their height, age and weight, may result in an increased risk of serious injury or death to your child.



WARNING: On hot days, the temperature inside the vehicle can rise very quickly. Exposure of people or animals to these high temperatures for even a short time can cause death or serious heat related injuries, including brain damage. Small children are particularly at risk.



WARNING: Do not place a rearward facing child restraint in front of an active airbag. Failure to follow this instruction could result in personal injury or death.



WARNING: Properly secure children 12 years old and under in a rear seating position whenever possible. If you are unable to properly secure all children in a rear seating position, properly secure the largest child on the front seat. If you must use a forward facing child restraint on the front seat, move the seat as far back as possible. Failure to follow these instructions could result in personal injury or death.



WARNING: Always carefully follow the instructions and warnings provided by the manufacturer of any child restraint to determine if the restraint device is appropriate for your child's size, height, weight, or age. Follow the child restraint manufacturer's instructions and warnings provided for installation and use in conjunction with the instructions and warnings provided by your vehicle manufacturer. A safety seat that is improperly installed or utilized, is inappropriate for your child's height, age, or weight or does not properly fit the child may increase the risk of serious injury or death.

Child Safety



WARNING: Do not allow a passenger to hold a child on their lap when your vehicle is moving. Failure to follow this instruction could result in personal injury or death in the event of a sudden stop or crash.



WARNING: Do not use pillows, books or towels to boost your child's height. Failure to follow this instruction could result in personal injury or death.



WARNING: Properly secure child restraints or booster seats when they are not in use. They could become projectiles in a sudden stop or crash. Failure to follow this instruction could result in personal injury or death.



WARNING: Do not put the shoulder section of the seatbelt or allow the child to put the shoulder section of the seatbelt under their arm or behind their back. Failure to follow this instruction could reduce the effectiveness of the seatbelt and increase the risk of injury or death in a crash.



WARNING: Do not leave children or pets unattended in your vehicle. Failure to follow this instruction could result in personal injury or death.

When installing a child restraint with seatbelts:

- Place the vehicle seat in the upright position before you install the child restraint.
- Use the correct seatbelt buckle for that seating position.
- Insert the belt tongue into the buckle. Make sure the tongue is securely fastened in the buckle.
- Keep the buckle release button pointing up and away from the child restraint, with the tongue between the child restraint and the release button, to prevent accidental unbuckling.
- Put the seatbelt in the automatic locking mode.

Child Safety

CHILD RESTRAINTS

CHILD RESTRAINT POSITION INFORMATION

Restraint Type	Combined Weight of Child and Child Restraint	Use Any Attachment Method as Indicated Below by X				
		LATCH (Lower Anchors and Top Tether Anchor)	LATCH (Lower Anchors Only)	Seatbelt and Top Tether Anchor	Seatbelt and LATCH (Lower Anchors and Top Tether Anchor)	Seatbelt Only
Rear facing child restraint	Up to 65 lb (29.5 kg)		X			X
Rear facing child restraint	Over 65 lb (29.5 kg)					X
Forward facing child restraint	Up to 65 lb (29.5 kg)	X		X	X	
Forward facing child restraint	Over 65 lb (29.5 kg)			X	X	

Note: *The child restraint must rest tightly against the vehicle seat upon which it is installed. It may be necessary to lift or remove the head restraint. See **Front Seat Precautions** (page 144).*

Child Safety

CHILD RESTRAINTS RECOMMENDATION

Child	Child Size, Height, Weight, or Age	Recommended Restraint Type
Infants or toddlers	Children weighing 40 lb (18 kg) or less (generally age four or younger).	Use a child restraint (sometimes called an infant carrier, convertible seat, or toddler seat).
Small children	Children who have outgrown or no longer properly fit in a child restraint (generally children who are less than 57 in (1.45 m) tall, are greater than age four and less than age 12, and between 40 lb (18 kg) and 79 lb (36 kg) and upward to 99 lb (45 kg) if recommended by your child restraint manufacturer).	Use a belt-positioning booster seat.
Larger children	Children who have outgrown or no longer properly fit in a belt-positioning booster seat (generally children who are at least 57 in (1.45 m) tall or greater than 79 lb (36 kg) or 99 lb (45 kg) if recommended by child restraint manufacturer).	Use a vehicle seatbelt having the lap belt snug and low across the hips, shoulder belt centered across the shoulder and chest, and seat backrest upright.

- You are required by law to properly use child restraints for infants and toddlers in the United States and Canada.
- Many states and provinces require that small children use approved booster seats until they reach age eight, a height of 57 in (1.45 m) tall, or 79 lb (36 kg). Check your local and state or provincial laws for specific requirements about the safety of children in your vehicle.
- When possible, always properly restrain children 12 years of age and under in a rear seating position of your vehicle. Accident statistics suggest that children are safer when properly restrained in the rear seating positions than in a front seating position.
- When installing a rear facing child restraint, adjust the vehicle seats to avoid interference between the child restraint and the vehicle seat in front of the child restraint.

Child Safety

INSTALLING CHILD RESTRAINTS

USING SEATBELTS



WARNING: Depending on where you secure a child restraint, and depending on the child restraint design, you may block access to certain seatbelt buckle assemblies and LATCH lower anchors, rendering those features potentially unusable. To avoid risk of injury, make sure occupants only use seating positions where they are able to be properly restrained.

Note: Although the child restraint illustrated is a forward facing child restraint, the steps are the same for installing a rear facing child restraint.

Perform the following steps when installing a child restraint with seatbelts.

1. Position the child restraint in a seat with a seatbelt.



2. Pull down on the shoulder belt and then grasp the shoulder belt and lap belt together.



3. While holding the shoulder and lap belt portions together, route the tongue through the child restraint according to the child restraint manufacturer's instructions. Make sure you did not twist the belt webbing.

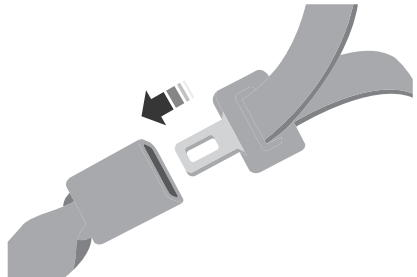

4. Insert the belt tongue into the proper buckle for that seating position until the latch engages. Make sure the tongue is latched securely by pulling on it.

Child Safety



5. To put the retractor in the automatic locking mode, grasp the shoulder portion of the belt and pull downward until you pull all of the seatbelt out.

Note: *The automatic locking mode is available on the front passenger and rear seats. This vehicle does not require the use of a locking clip.*

6. Allow the belt to retract to remove slack. The seatbelt clicks as it retracts to indicate it is in the automatic locking mode.
7. Pull the seatbelt out of the retractor to make sure the retractor is in the automatic locking mode. You should not be able to pull more belt out. If the retractor is not locked, unbuckle the belt and repeat Steps 5 and 6.



8. Remove remaining slack from the belt. Force the seat down with extra weight, for example, by pressing down or kneeling on the child restraint while pulling up on the shoulder belt in order to force slack from the belt. This is necessary to remove the remaining slack that exists once you add the extra weight of the child to the child restraint. It also helps to achieve the proper snugness of the child restraint to your vehicle. Sometimes, a slight lean toward the buckle helps to remove remaining slack from the belt.
9. If the child restraint has a tether strap, attach it.



10. Before placing the child in the seat, forcibly move the seat forward and back to make sure the seat is securely held in place.

To check this, grab the seat at the belt path and attempt to move it side to side and forward and back. There should be no more than 1 in (2.5 cm) of movement.

We recommend checking with a NHTSA Certified Child Passenger Safety Technician to make certain the child restraint is properly installed. In Canada, check with Transport Canada for referral to a Child Car Seat Clinic.

Child Safety

USING LOWER ANCHORS AND TETHERS FOR CHILDREN



WARNING: Do not attach two child safety restraints to the same anchor. In a crash, one anchor may not be strong enough to hold two child safety restraint attachments and may break, causing serious injury or death.



WARNING: Depending on where you secure a child restraint, and depending on the child restraint design, you may block access to certain seatbelt buckle assemblies and LATCH lower anchors, rendering those features potentially unusable. To avoid risk of injury, make sure occupants only use seating positions where they are able to be properly restrained.

The LATCH system has three vehicle anchor points:

- Two lower anchors where the vehicle seat backrest and seat cushion meet, called the seat bight.
- One top tether anchor behind that seating position.

LATCH compatible child restraints have two rigid or webbing mounted attachments. These attachments connect to the two lower anchors at the LATCH equipped seating positions in your vehicle. This type of attachment method eliminates the need to use seatbelts to attach the child restraint.

However, you can still use the seatbelt to attach the child restraint if the lower anchors are not used. For forward-facing child restraints, you must also attach the top tether strap to the proper top tether anchor if a top tether strap has been provided with your child restraint.

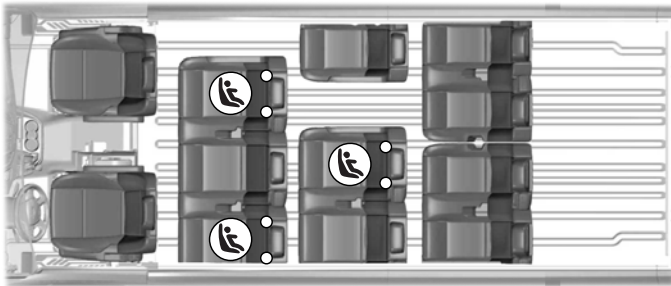

Child Safety

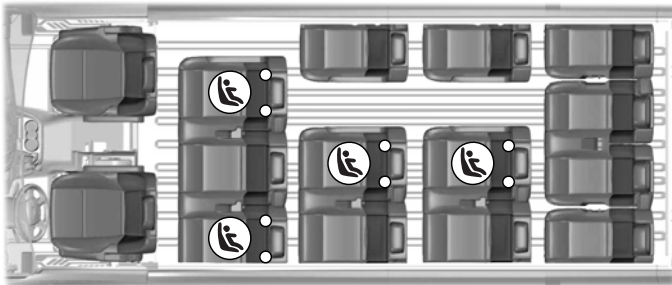
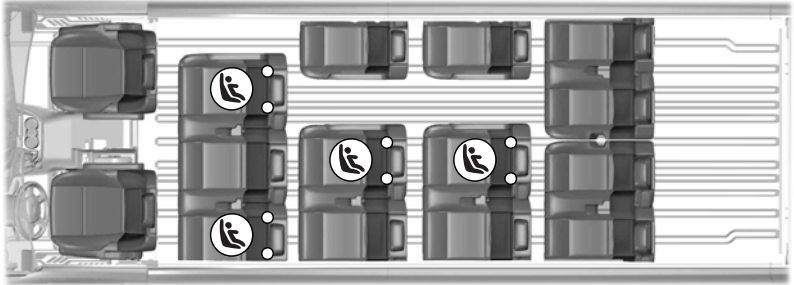

INSTALLING A CHILD RESTRAINT IN A CENTER SEAT



WARNING: The standardized spacing for LATCH lower anchors is 11 in (280 mm) center to center. Do not use LATCH lower anchors for the center seating position unless the child restraint manufacturer's instructions permit and specify using anchors spaced at least as far apart as those in this vehicle.

The lower anchors at the center of the second row rear seat are spaced 25.7 in (652 mm) apart. The standardized spacing for LATCH lower anchors is 11 in (280 mm) center to center.

Child Safety

You cannot install a child restraint with rigid LATCH attachments at the center seating position. You can only use LATCH compatible child restraints with attachments on belt webbing at this seating position provided that the child restraint manufacturer's instructions permit use with the anchor spacing stated. Do not attach a child restraint to any lower anchor if another child restraint is attached to that anchor.

Each time you use the child restraint, check that the seat is properly attached to the lower anchors and tether anchor, if applicable. Tug the child restraint from side to side and forward and back where it is secured to the vehicle. The seat should move less than 1 in (2.5 cm).

If you did not properly anchor the child restraint, the risk of a child being injured in a crash greatly increases.

COMBINING THE SEATBELT AND LOWER ANCHORS FOR ATTACHING CHILD RESTRAINTS

When used in combination, you may attach either the seatbelt or the LATCH lower anchors first, provided a proper installation is achieved. Attach the tether strap afterward, if it is included with the child restraint.

USING TETHER STRAPS

Many forward-facing child restraints include a tether strap which extends from the back of the child restraint and hooks to an anchoring point called the top tether anchor. Tether straps are available as an accessory for many older child restraints.

Contact the manufacturer of your child restraint for information about ordering a tether strap, or to obtain a longer tether strap if the tether strap on your child restraint does not reach the appropriate top tether anchor in the vehicle.

Attach the tether strap only to the appropriate tether anchor. The tether strap may not work properly if attached somewhere other than the correct tether anchor.

If you install a child restraint with rigid LATCH attachments, do not tighten the tether strap enough to lift the child restraint off the vehicle seat cushion when the child is seated in it. Keep the tether strap just snug without lifting the front of the child restraint. Keeping the child restraint just touching the vehicle seat gives the best protection in a severe crash.

Once you have installed the child restraint using either the seatbelt, the lower anchors of the LATCH system, or both, you can attach the top tether strap.

The tether strap anchors in your vehicle are in the following positions (shown from top view):

Child Safety

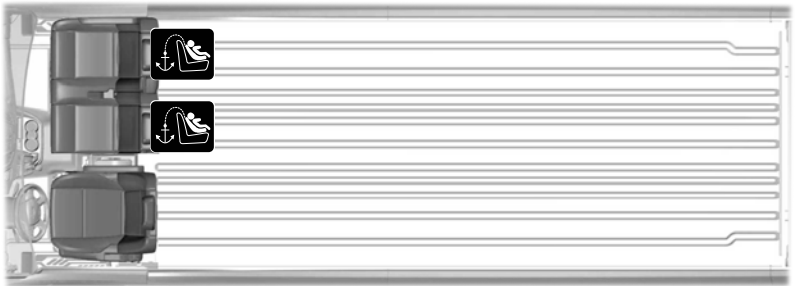
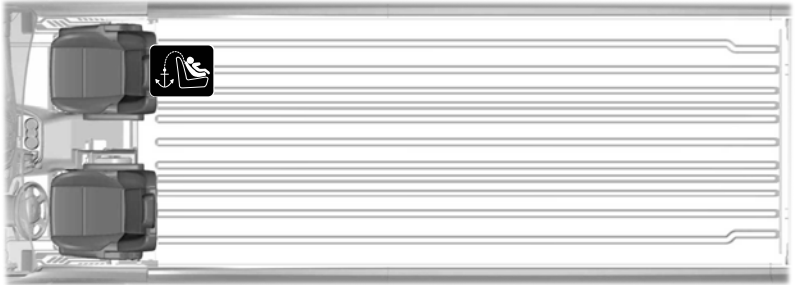

Child Safety

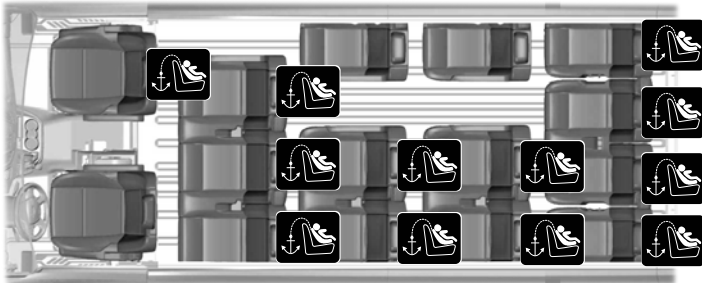

Child Safety

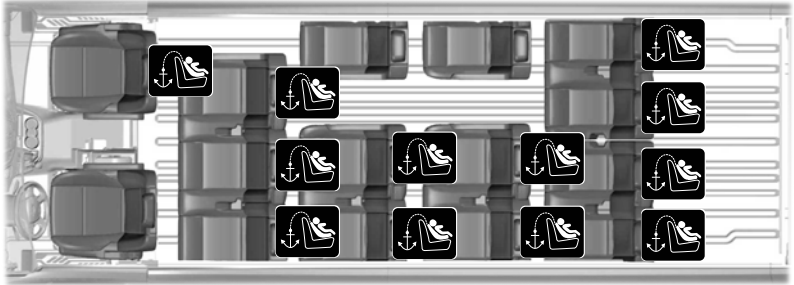

Child Safety

ATTACHING THE FRONT SEAT TETHER STRAP

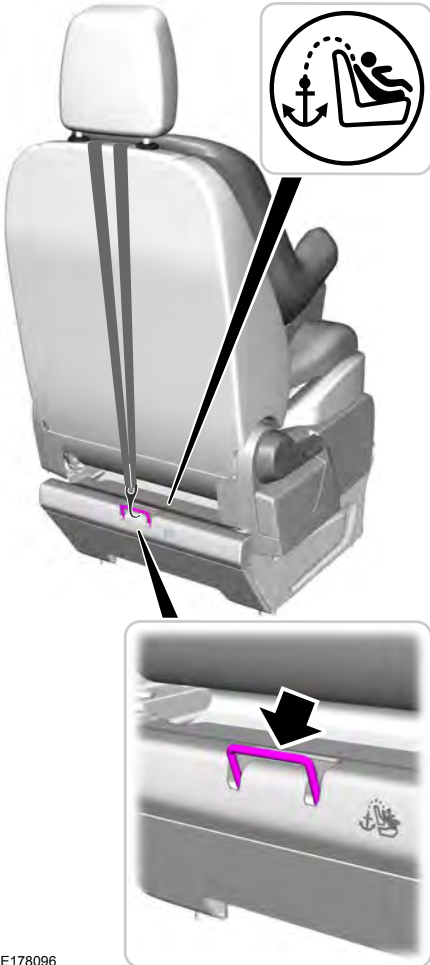

E178096

1. Adjust the front passenger seat fully forward.

2. Route the child restraint tether strap over the back of the seat and under the head restraint.

Note: For vehicles with adjustable head restraints, route the tether strap under the head restraint and between the head restraint posts. Otherwise, route the tether strap over the top of the seat backrest.

3. Locate the correct anchor for the selected seating position. You may need to pull the seat backrest forward to access the tether anchors. Make sure the seat is locked in the upright position before installing the child restraint.
4. Clip the tether strap to the anchor.
5. Tighten the child restraint tether strap according to the manufacturer's instructions.

If you incorrectly clip the tether strap, the child restraint may not be retained properly in the event of a crash.

If you did not properly anchor the child restraint, the risk of a child being injured in a crash greatly increases.

If your child restraint system has a tether strap, and the child restraint manufacturer recommends its use, we also recommend its use.

ATTACHING THE REAR SEAT TETHER STRAP

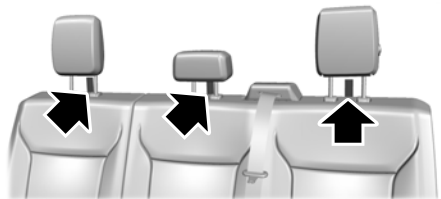

Child Safety

There are three loops of webbing above the back of the rear seat. Use these loops as routing loops and anchor loops for up to three child restraint tether straps.

For example, you can use the center loop as a routing loop for a child restraint in the center rear seat and as an anchoring loop for child restraints installed in the outermost rear seats.

Many tether straps cannot be tightened if the tether strap is hooked to the loop directly behind the child restraint.

To provide a tight tether strap:

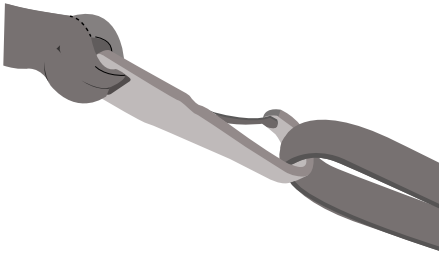

1. Route the vehicle tether loop between the head restraint posts, then route the child restraint tether strap through the loop, forward of the head restraint.
2. Hook the strap to the vehicle tether anchor loop in the adjacent seating position. If using the driver side, pass the strap behind the shoulder belt for the center seat. Put the tether strap through the routing loop. The head restraint support post holds the child restraint tightly, but the head restraint post is not strong enough to hold the child restraint during a crash.
3. Tighten the tether strap according to the child restraint manufacturer's instructions.

Perform the following steps to install a child safety restraint with tether anchors:

1. Route the child safety restraint tether strap over the back of the seat, under the head restraint and between the head restraint posts.



E177640

2. Locate the correct anchor on the back panel of the seat for the selected seating position. The anchors are labeled with the tether strap symbol and are partially covered by the gap panel. Pull the panel back to fully expose the anchors.
3. Clip the tether strap to the anchor as shown.
4. Tighten the child safety restraint tether strap according to the manufacturer's instructions.

If you did not properly anchor the child restraint, the risk of a child being injured in a crash greatly increases.

Child Safety

If your child restraint system has a tether strap, and the child restraint manufacturer recommends its use, we also recommend its use.

BOOSTER SEATS

Use a belt-positioning booster seat for children who have outgrown or no longer properly fit in a child restraint and meet the following criteria.

- Generally children who are less than 57 in (1.45 m) tall.
- Are greater than age four (4) and less than age twelve (12).
- Are between 40 lb (18 kg) and 80 lb (36 kg) and upward to 100 lb (45 kg).

Many state and provincial laws require that children use approved booster seats until they reach age eight, a height of 57 in (1.45 m) tall, or 80 lb (36 kg).

Booster seats should be used until you can answer yes to all of these questions when seated without a booster seat:

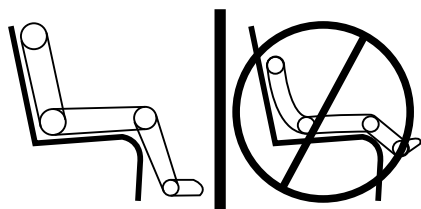

- Can the child sit all the way back against their vehicle seat backrest with knees bent comfortably at the edge of the seat cushion?
- Can the child sit without slouching?
- Does the lap belt rest low across the hips?

- Is the shoulder belt centered on the shoulder and chest?
- Can the child stay seated like this for the whole trip?

Always use booster seats in conjunction with your vehicle lap and shoulder belt.

Types of Booster Seats



- Backless booster seats

If your backless booster seat has a removable shield, remove the shield.

If a vehicle seating position has a low seat backrest or no head restraint, a backless booster seat may place your child's head, as measured at the tops of the ears, above the top of the seat. In this case, move the backless booster to another seating position with a higher seat backrest or head restraint and lap and shoulder belts, or consider using a high-back booster seat.

Child Safety



- High-back booster seats

If, with a backless booster seat, you cannot find a seating position that adequately supports your child's head, a high-back booster seat would be a better choice.

Children and booster seats vary in size and shape. Choose a booster that keeps the lap belt low and snug across the hips, never up across the stomach, and lets you adjust the shoulder belt to cross the chest and rest snugly near the center of the shoulder.

The following drawings compare the ideal fit to a shoulder belt uncomfortably close to the neck and a shoulder belt that could slip off the shoulder. The drawings also show how the lap belt should be low and snug across the child's hips.



Child Safety

If the booster seat slides on the vehicle seat upon which it is being used, placing a rubberized mesh sold as shelf or carpet liner under the booster seat may improve this condition. Do not use any item thicker than this under the booster seat. Check with the booster seat manufacturer's instructions.

Note: To open the rear doors from inside the vehicle when the child lock is engaged, roll down the rear window and use the outside door handle. Or have someone outside the vehicle open the door.

CHILD SAFETY LOCKS



WARNING: You cannot open the rear doors from inside if you have put the child safety locks on.



A child safety lock is on the rear edge of each rear door.

You must set the child safety lock separately on each door.

Left-Hand Side

Turn it counterclockwise to switch the child lock on and clockwise to switch it off.

Right-Hand Side

Turn it clockwise to switch the child lock on and counterclockwise to switch it off.

Note: To make sure the child safety lock is on, pull the inside door handle twice to verify the door does not open.

Seatbelts

SEATBELT PRECAUTIONS



WARNING: Make sure that the seatbelts are securely stowed away when not in use and not outside your vehicle when closing the doors.



WARNING: Always drive and ride with your seatback upright and the lap belt snug and low across the hips.



WARNING: Do not allow a passenger to hold a child on their lap when your vehicle is moving. Failure to follow this instruction could result in personal injury or death in the event of a sudden stop or crash.



WARNING: All occupants of your vehicle, including the driver, should always properly wear their seatbelts, even when an airbag supplemental restraint system is provided. Failure to properly wear your seatbelt could seriously increase the risk of injury or death.



WARNING: It is extremely dangerous to ride in a cargo area, inside or outside of a vehicle. In a crash, people riding in these areas are more likely to be seriously injured or killed. Do not allow people to ride in any area of your vehicle that is not equipped with seats and seatbelts. Make sure everyone in your vehicle is in a seat and properly using a seatbelt. Failure to follow this warning could result in serious personal injury or death.



WARNING: In a rollover crash, an unbelted person is significantly more likely to die than a person wearing a seatbelt.



WARNING: Each seating position in your vehicle has a specific seatbelt assembly made up of one buckle and one tongue designed to be used as a pair. Use the shoulder belt on the outside shoulder only. Never wear the shoulder belt under the arm. Never use a single seatbelt for more than one person.



WARNING: Properly secure children 12 years old and under in a rear seating position whenever possible. If you are unable to properly secure all children in a rear seating position, properly secure the largest child on the front seat. If you must use a forward facing child restraint on the front seat, move the seat as far back as possible. Failure to follow these instructions could result in personal injury or death.



WARNING: Seatbelts and seats may be hot in a vehicle that is in the sunshine. The hot seatbelts or seats may burn a small child. Check seat covers and buckles before you place a child anywhere near them.

FASTENING AND UNFASTENING THE SEATBELTS

Fastening the Seatbelts

All seatbelts in your vehicle are a three-point combination lap and shoulder seatbelt.

Seatbelts

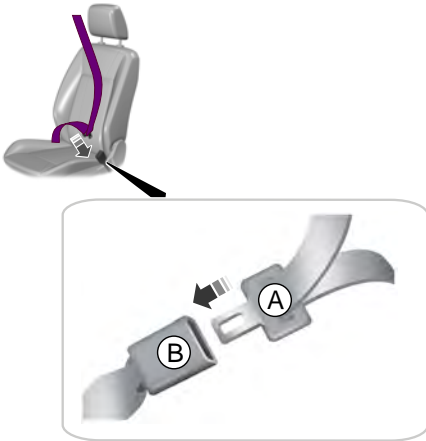

- A Seatbelt tongue.
- B Seatbelt buckle.

1. Pull the seatbelt out steadily.

Note: It may lock if you pull it sharply or if the vehicle is on a slope.

2. Insert the tongue into the buckle.
3. Pull the seatbelt tight to remove any slack.

Unfastening the Seatbelts

1. Press the red button on the buckle to release the seatbelt.
2. Hold the seatbelt tongue and let it retract completely and smoothly to its stowed position.

SENSITIVE LOCKING MODE

WHAT IS SENSITIVE LOCKING MODE

Sensitive locking mode is a seatbelt retractor feature that allows shoulder belt length adjustment according to your movements and locking in response to vehicle movement.

HOW DOES SENSITIVE LOCKING MODE WORK

If the driver suddenly brakes, turns a corner sharply, or the vehicle receives an impact of about 5 mph (8 km/h) or more, the seatbelts lock to help reduce forward movement of the driver and passengers.

In addition, the seatbelt retractor locks if you pull the seatbelt webbing out too quickly. If the retractor locks, slowly lower the height adjuster to allow the seatbelt to retract.

If the retractor does not unlock, pull the seatbelt out slowly then feed a small length of webbing back toward the stowed position.

For rear seatbelts, recline the rear seat backrest or push the seat backrest cushion away from the seatbelt. Feed a small length of webbing back toward the stowed position.

AUTOMATIC LOCKING MODE

WHAT IS AUTOMATIC LOCKING MODE

This feature keeps the seatbelts pre-locked. The belt still retracts to remove any slack in the shoulder belt.

Seatbelts

WHEN TO USE AUTOMATIC LOCKING MODE

Use this mode any time you install a child restraint in a front or rear seating position. Properly restrain children 12 years old and under in a rear seat whenever possible. See **Child Safety** (page 34).

Note: Automatic locking mode is not available on the driver seatbelt.

Note: Vehicles with optional front seat center may not have this function.

ENGAGING AUTOMATIC LOCKING MODE



1. Fasten the combination lap and shoulder belt.
2. Grasp the shoulder portion and pull downward until you pull the entire belt out.
3. Allow the belt to retract. As the belt retracts, you will hear a clicking sound. This indicates the seatbelt is now in the automatic locking mode.

DISENGAGING AUTOMATIC LOCKING MODE

Unbuckle the combination lap and shoulder belt and allow it to retract completely to disengage the automatic locking mode and activate the vehicle sensitive locking mode.

ADJUSTING THE SEATBELTS DURING PREGNANCY

WARNING: Position the seatbelt correctly for your safety and that of your unborn child. Do not use only the lap strap or the shoulder strap.

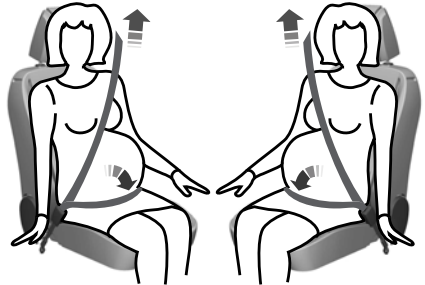

Pregnant women should always wear their seatbelt. The lap belt portion of a combination lap and shoulder belt should be positioned low across the hips below the belly and worn as tight as comfort will allow. The shoulder belt portion of a combination lap and shoulder belt should be positioned to cross the middle of the shoulder and the center of the chest.

Seatbelts

ADJUSTING THE SEATBELT HEIGHT



WARNING: Position the seatbelt height adjuster so that the seatbelt rests across the middle of your shoulder. Failure to adjust the seatbelt correctly could reduce its effectiveness and increase the risk of injury in a crash.

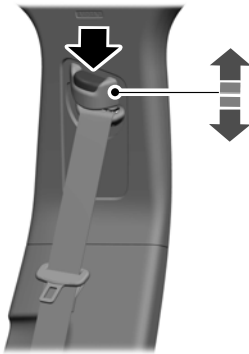

1. Press the button and slide the height adjuster up or down.
2. Release the button and pull down on the height adjuster to make sure it is locked in place.

ADJUSTING THE SEATBELT LENGTH



1. Pull some seatbelt webbing out of the shoulder belt retractor.
2. While holding the webbing below the tongue, grasp the metal tip of the tongue so that it is parallel to the webbing and slide the tongue up.
3. Provide enough lap belt length so that the tongue can reach the buckle.

SEATBELT REMINDER

HOW DOES THE SEATBELT REMINDER WORK

This feature supplements the seatbelt warning function by providing additional reminders that intermittently sound a tone and illuminate the seatbelt warning lamp when you are in the driver seat or you have a front seat passenger and a seatbelt is unbuckled.

Seatbelts

The system uses information from the front passenger sensing system to determine if a front seat passenger is present and therefore potentially in need of a warning. To avoid the system switching on the Belt-Minder feature for objects you place on the front passenger seat, only the front seat passengers receive

warnings as determined by the front passenger sensing system.

If the Belt-Minder warnings expire (warnings for about five minutes) for one passenger (driver or front passenger), the other passenger can still cause the Belt-Minder feature to switch on.

If	Then
You and the front seat passenger buckle your seatbelts before you switch the ignition on or less than 1–2 minutes elapse after you switch the ignition on...	The Belt-Minder feature will not activate.
You or the front seat passenger do not buckle your seatbelts before your vehicle reaches at least 6.0 mph (9.7 km/h) and 1–2 minutes elapse after you switch the ignition on...	The Belt-Minder feature activates, the seatbelt warning lamp illuminates and an indicator tone sounds for 6 seconds every 25 seconds, repeating for about 5 minutes or until you and the front seat passenger buckle your seatbelts.
The seatbelt for the driver or front passenger is unbuckled for about 1 minute while the vehicle is traveling at least 6.0 mph (9.7 km/h) and more than 1–2 minutes elapse after you switch the ignition on...	The Belt-Minder feature activates, the seatbelt warning lamp illuminates and an indicator tone sounds for 6 seconds every 25 seconds, repeating for about 5 minutes or until you and the front seat passenger buckle your seatbelts.

Seatbelts

SEATBELT REMINDER INDICATORS

A warning lamp illuminates if the ignition is on, a front seat is occupied and the seatbelt has not been fastened.



The warning lamp illuminates until you fasten your seatbelt.

SEATBELT REMINDER AUDIBLE WARNINGS

A warning tone sounds and the warning lamp illuminates if you are not wearing your seatbelt when your vehicle exceeds a relatively low speed.

The warning tone sounds for a short period of time or until you fasten your seatbelt.

SWITCHING THE SEATBELT REMINDER ON AND OFF



WARNING: While the system allows you to deactivate it, this system is designed to improve your chances of being safely belted and surviving an accident. We recommend you leave the system activated for yourself and others who may use the vehicle.

Note: The driver and front passenger warnings switch off independently. When you perform this procedure for one seating position, do not buckle the other position as this cancels the process.

Note: If you are using MyKey, you cannot disable the seatbelt reminder. Also, if the seatbelt reminder has been previously disabled, it will be re-enabled during the use of MyKey. See **MyKey™** (page 79).

Read Steps 1 - 4 before proceeding with the programming procedure.

Make sure that:

- The parking brake is set.
 - The transmission is in park (P).
 - The ignition is off.
 - The driver and front passenger seatbelts are unfastened.
1. Switch the ignition on. Do not start the engine.
 2. Wait about one minute until the seatbelt warning light switches off. After Step 2, wait an additional five seconds before proceeding with Step 3. Once you start Step 3, you must complete the procedure within 30 seconds.
 3. For the seating position you are switching off, buckle then unbuckle the seatbelt three times at a moderate speed, ending in the unbuckled state. After Step 3, the seatbelt warning light switches on.
 4. When the seatbelt warning light is on, buckle then unbuckle the seatbelt. After Step 4, the seatbelt warning light flashes for confirmation.

This switches the feature off for that seating position if it is currently on.

This switches the feature on for that seating position if it is currently off.

Seatbelts

CHECKING SEATBELT STATUS



- A Seatbelt fastened.
- B Seatbelt not fastened.
- C Rear seatbelt recently unfastened.
- D Fault.

Checking Seatbelt Status

1. Press the menu button on the steering wheel to enter the information display main menu.
2. Select **Settings**.
3. Select **Information**.
4. Select **Seatbelts**.

CHECKING THE SEATBELTS

Check the seatbelts and child restraints periodically to make sure they work properly and are not damaged. Make sure there are no nicks, tears or cuts. Replace if necessary.

Check the following seatbelt assemblies after a crash.

- Retractors.
- Buckles.
- Front seatbelt buckle assemblies.
- Shoulder belt height adjusters.
- Shoulder belt guide on seat backrest.

- Child restraint LATCH and tether anchors.
- Attaching hardware.

Read the child restraint manufacturer's instructions for additional inspection and maintenance information specific to the child restraint.

We recommend that all seatbelt assemblies in use in vehicles involved in a crash be replaced. However, if the crash was minor and an authorized dealer finds that the belts do not show damage and continue to operate properly, they do not need to be replaced. Seatbelt assemblies not in use during a crash should also be checked and replaced if either damage or improper operation is noted.

Properly care for seatbelts. See **Cleaning Seatbelts** (page 406).

SEATBELT EXTENSIONS



WARNING: Persons who fit into the vehicle's seatbelt should not use an extension. Unnecessary use could result in serious personal injury in the event of a crash.



WARNING: Only use extensions provided free of charge by our dealers. The dealer will provide an extension designed specifically for this vehicle, model year and seating position. The use of an extension intended for another vehicle, model year or seating position may not offer you the full protection of your vehicle's seatbelt restraint system.



WARNING: Never use seatbelt extensions to install child restraints.

Seatbelts



WARNING: Do not use extensions to change the way the seatbelt fits across the torso, over the lap or to make the seatbelt buckle easier to reach.

If, because of body size or driving position, it is not possible to properly fasten the seatbelt over your lap and shoulder, an extension that is compatible with the seatbelts is available free of charge from our dealers. Only use our seatbelt extensions made by the original equipment seatbelt manufacturer with our seatbelts. Ask your authorized dealer if your extension is compatible with your vehicle restraint system.

WHAT IS THE PERSONAL SAFETY SYSTEM

An advanced safety system that protects occupants in frontal crashes.

HOW DOES THE PERSONAL SAFETY SYSTEM WORK

This system provides an improved level of frontal crash protection to front seat occupants and is designed to reduce the risk of airbag-related injuries. The system analyzes occupant conditions and crash severity before activating the appropriate safety devices. During a crash, the restraints control module may deploy the seatbelt pretensioners and airbags based on crash severity and occupant conditions.

PERSONAL SAFETY SYSTEM COMPONENTS

- Driver and passenger airbag supplemental restraints.
- Front seat outermost seatbelts with pretensioners, energy management retractors and seatbelt usage sensors.
- Front passenger sensing system.
- Passenger airbag off and on indicators.
- Front crash severity sensors.
- Restraints control module with impact and safing sensors.
- Restraint system warning light and tone.
- The electrical wiring for the airbags, crash sensors, seatbelt pretensioners, front seatbelt usage sensors, front passenger sensing system and indicator lights.

Airbags

HOW DO THE FRONT AIRBAGS WORK

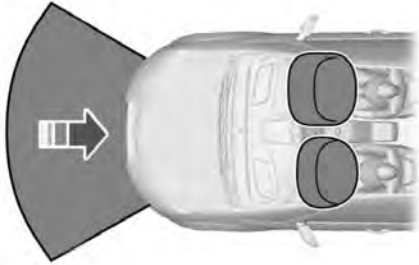

The driver and front passenger airbags deploy during significant frontal and near frontal crashes.

The driver and passenger front airbag system consists of:

- Driver and passenger airbag modules.
- Front passenger sensing system.
- Crash sensors and monitoring system with readiness indicator. See **Crash Sensors and Airbag Indicator** (page 68).

The airbags are a supplemental restraint system and are designed to work with the seatbelts to help protect the driver and right front passenger from certain upper body injuries. Airbags do not inflate slowly; there is a risk of injury from a deploying airbag.

Note: *You will hear a loud bang and see a cloud of harmless powdery residue if an airbag deploys. This is normal.*

The airbags inflate and deflate rapidly upon activation. After airbag deployment, it is normal to notice a smoke-like, powdery residue or smell the burnt propellant. This may consist of cornstarch, talcum powder (to lubricate the bag) or sodium

compounds (for example, baking soda) that result from the combustion process that inflates the airbag. Small amounts of sodium hydroxide may be present which may irritate the skin and eyes, but none of the residue is toxic.

Contact with a deploying airbag may cause abrasions or swelling. Temporary hearing loss is also a possibility as a result of the noise associated with a deploying airbag.

Because airbags must inflate rapidly and with considerable force, there is the risk of death or serious injuries such as fractures, facial and eye injuries or internal injuries, particularly to occupants who are not properly restrained or are otherwise out of position at the time of airbag deployment. Thus, it is extremely important that occupants be properly restrained as far away from the airbag module as possible.

Routine maintenance of the airbags is not required.

HOW DO THE SIDE AIRBAGS WORK



WARNING: Do not place objects or mount equipment on or near the airbag cover, on the side of the front or rear seatbacks, or in areas that may come into contact with a deploying airbag. Failure to follow these instructions may increase the risk of personal injury in the event of a crash.



WARNING: Accessory seat covers not released by Ford Motor Company could prevent the deployment of the airbags and increase the risk of injuries in a crash.

Airbags



WARNING: Do not lean your head on the door. The side airbag could injure you as it deploys from the side of the seatback.

The side airbags are on the outermost side of the seat backrests of the front seats. In certain sideways crashes or rollovers, the airbags will be inflated. The airbag was designed to inflate between the door panel and occupant to further enhance the protection provided to occupants in side impact crashes.



The system consists of the following:

- A label or embossed side panel indicating that side airbags are fitted to your vehicle.
- Side airbags inside the driver and front passenger seat backrests.
- Crash sensors and monitoring system with readiness indicator. See **Crash Sensors and Airbag Indicator** (page 68).

HOW DOES THE SAFETY CANOPY™ WORK



WARNING: Do not place objects or mount equipment on or near the headliner at the siderail that may come into contact with a deploying curtain airbag. Failure to follow these instructions may increase the risk of personal injury in the event of a crash.



WARNING: Do not lean your head on the door. The curtain airbag could injure you as it deploys from the headliner.



WARNING: To reduce risk of injury, do not obstruct or place objects in the deployment path of the airbag.

The Safety Canopy deploys during significant side crashes or when a certain likelihood of a rollover event is detected by the rollover sensor. The Safety Canopy is mounted to the roof side-rail sheet metal, behind the headliner, above each row of seats. In certain sideways crashes or rollover events, the Safety Canopy will be activated, regardless of which seats are occupied. The Safety Canopy inflates between the side window area and occupants to further enhance protection provided in side impact crashes and rollover events.

Airbags

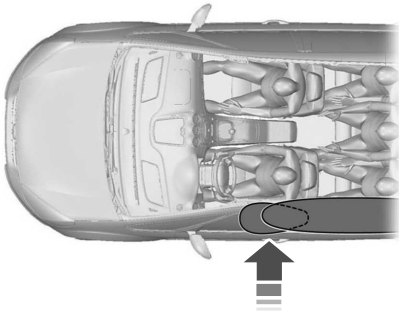

The system consists of the following:

- Safety Canopy curtain airbags above the trim panels over the front and rear side windows identified by a label or wording on the headliner or roof-pillar trim.
- A flexible headliner which opens above the side doors to allow air curtain deployment



• Crash sensors and monitoring system with a readiness indicator. See **Crash Sensors and Airbag Indicator** (page 68).

Properly restrain children 12 years old and under in the rear seats. The Safety Canopy will not interfere with children restrained using a properly installed child or booster seat because it is designed to inflate downward from the headliner above the doors along the side window opening.

AIRBAG PRECAUTIONS



WARNING: Airbags do not inflate slowly or gently, and the risk of injury from a deploying airbag is the greatest close to the trim covering the airbag module.



WARNING: All occupants of your vehicle, including the driver, should always properly wear their seatbelts, even when an airbag supplemental restraint system is provided. Failure to properly wear your seatbelt could seriously increase the risk of injury or death.



WARNING: Properly secure children 12 years old and under in a rear seating position whenever possible. If you are unable to properly secure all children in a rear seating position, properly secure the largest child on the front seat. If you must use a forward facing child restraint on the front seat, move the seat as far back as possible. Failure to follow these instructions could result in personal injury or death.



WARNING: Do not place your arms on the airbag cover or through the steering wheel. Failure to follow this instruction could result in personal injury.



WARNING: Keep the areas in front of the airbags free from obstruction. Do not affix anything to or over the airbag covers. Objects could become projectiles during airbag deployment. Failure to follow this instruction could result in personal injury or death.





WARNING: To reduce risk of injury, do not obstruct or place objects in the deployment path of the airbag.





WARNING: Do not place a rearward facing child restraint in front of an active airbag. Failure to follow this instruction could result in personal injury or death.

Airbags

 **WARNING:** Do not attempt to service, repair, or modify the supplementary restraint system or associated components. Failure to follow this instruction could result in personal injury or death.

 **WARNING:** Several airbag system components get hot after inflation. To reduce the risk of injury, do not touch them after inflation.

 **WARNING:** If a supplementary restraint system component has deployed, it will not function again. Have the system and associated components inspected as soon as possible. Failure to follow this instruction could result in personal injury or death.

 **WARNING:** The front passenger airbag is not designed to offer protection to an occupant in the center seating position.

 **WARNING:** Your vehicle may have an airbag deactivation switch. Before driving, always look at the switch to make sure it is in the appropriate position. Failure to put the switch in the proper position can increase the risk of serious injury or death in a crash.



SWITCHING THE PASSENGER AIRBAG ON AND OFF

 **WARNING:** Even with advanced restraints systems, properly restrain children 12 and under in a rear seating position. Failure to follow this could seriously increase the risk of injury or death.

E279408

The front passenger airbag on and off switch has indicators that illuminate, indicating that the front passenger frontal airbag is either on or off. The indicators are near the center of the instrument panel.

Note: *The indicators illuminate for a short period of time when you switch the ignition on to confirm it is functional.*

Switch Position	Passenger Airbag Status Indicator	Passenger Airbag
Off	OFF: Illuminated	Disabled
	ON: Not Illuminated	
On	OFF: Not Illuminated	Enabled
	ON: Illuminated	

Airbags

Switching the Passenger Airbag Off

WARNING: If the light does not illuminate when the passenger airbag switch is off and you switch the ignition on, have the passenger airbag switch serviced immediately by a qualified technician.

WARNING: To avoid switching on the airbag, always remove the ignition key with the switch in the off position.

WARNING: If your vehicle has rear seats, always transport children who are 12 and younger in the rear seat. Always use seatbelts and child restraints properly. Do not place a child in a rear facing infant seat in the front seat unless your vehicle is equipped with an airbag on and off switch and the passenger airbag is turned off. This is because the back of the infant seat is too close to the inflating airbag and the risk of a fatal injury to the infant when the airbag inflates is substantial.

The passenger airbag on and off switch is in the glovebox.



1. Insert the ignition key, turn the switch to OFF and hold in OFF while removing the key.
2. When you switch the ignition on, the passenger airbag off light illuminates briefly, momentarily shuts off and then switches back on. This indicates that the passenger airbag is deactivated.

Switching the Passenger Airbag On

WARNING: The seatbelts for the driver and right front passenger seating positions are specifically designed to operate together with the airbags in certain types of crashes. When you switch off your airbag, you not only lose the protection of the airbag, you also may reduce the effectiveness of your seatbelt system. If the passenger does not meet the requirements stated in the National Highway Traffic Safety Administration or Transport Canada deactivation criteria, switching off the airbag can increase the risk of serious injury or death in a crash.

WARNING: If your vehicle has rear seats, always transport children who are 12 and younger in the rear seat. Always use seatbelts and child restraints properly. Do not place a child in a rear facing infant seat in the front seat unless your vehicle is equipped with an airbag on and off switch and the passenger airbag is turned off. This is because the back of the infant seat is too close to the inflating airbag and the risk of a fatal injury to the infant when the airbag inflates is substantial.

Airbags



WARNING: If the passenger airbag off light is illuminated when the passenger airbag switch is on and the ignition is on, have the passenger airbag switch serviced immediately by a qualified technician.

The passenger airbag remains off until you switch it back on.



1. Insert the ignition key and turn the switch to ON.
2. The passenger airbag off light briefly illuminates when you switch the ignition on. This indicates that the passenger airbag is operational.

The passenger side airbag should always be on, and the passenger airbag off light should not be illuminated, unless the passenger is a person who meets the requirements stated either in Category 1, 2 or 3 of the National Highway Traffic Safety Administration or Transport Canada deactivation criteria which follows.

The vast majority of drivers and passengers are much safer with an airbag than without. To do their job and reduce the risk of life threatening injuries, airbags must open with great force, and this force can pose a potentially deadly risk in some situations, particularly when a front seat occupant is not properly buckled up. The most effective way to reduce the risk of unnecessary airbag injuries without reducing the overall safety of the vehicle is to make sure all occupants are properly restrained in the vehicle, especially in the front seat. This provides the protection of seatbelts and permits the airbags to provide the additional protection they were designed to provide. If you choose to deactivate your airbag, you are losing the very significant risk reducing benefits of the airbag and you are also reducing the effectiveness of the seatbelts. Seatbelts in modern vehicles are designed to work as a safety system with the airbags.

National Highway Traffic Safety Administration Deactivation Criteria-Excluding Canada



WARNING: This vehicle has special energy management seatbelts for the driver and right front passenger. These particular seatbelts are specifically designed to work with airbags to help reduce the risk of injury in a crash. The energy management seatbelt gives or releases additional seatbelt webbing in some accidents to reduce the concentration of force on an occupant's chest and to reduce the risk of certain bone fractures and injuries to underlying organs. In a crash, if the airbag is off, this energy management seatbelt might permit the passenger wearing the seatbelt to move forward enough to have a serious or fatal injury. The more

Airbags

severe the crash, and the heavier the occupant, the greater the risk. Make sure the airbag is on for any passenger who does not qualify under the National Highway Traffic Safety Administration deactivation criteria.

1. **Infant.** An infant, less than 1 year old, must ride in the front seat because:

- The vehicle has no rear seat.
- The vehicle has a rear seat too small to accommodate a rear-facing infant seat.
- The infant has a medical condition which, according to the infant's physician, makes it necessary for the infant to ride in the front so that the driver can constantly monitor the child's condition.

2. **Children age 1 to 12.** Children age 1 to 12 must ride in the front seat because:

- The vehicle has no rear seat.
- Although children ages 1 to 12 ride in the rear seat(s) whenever possible, children ages 1 to 12 sometimes must ride in the front because no space is available in the rear seat(s) of your vehicle.
- The child has a medical condition which, according to the child's physician, makes it necessary for the child to ride in the front seat so that the driver can constantly monitor the child's condition.

3. **Medical condition.** A passenger has a medical condition which, according to his or her physician:

- Causes the passenger airbag to pose a special risk for the passenger.
- Makes the potential harm from the passenger airbag in a crash greater than the potential harm from turning off the airbag and allowing the passenger, even if belted, to hit the dashboard or windshield in a crash.

Transport Canada Deactivation Criteria-Canada Only



WARNING: This vehicle has special energy management seatbelts for the driver and right front passenger. These particular seatbelts are specifically designed to work with airbags to help reduce the risk of injury in a crash. The energy management seatbelt gives or releases additional seatbelt webbing in some accidents to reduce the concentration of force on an occupant's chest and to reduce the risk of certain bone fractures and injuries to underlying organs. In a crash, if the airbag is off, this energy management seatbelt might permit the passenger wearing the seatbelt to move forward enough to have a serious or fatal injury. The more severe the crash, and the heavier the occupant, the greater the risk. Make sure the airbag is on for any passenger who does not qualify under the Transport Canada deactivation criteria.

1. **Infant:** An infant, less than 1 year old, must ride in the front seat because:

Airbags

- The vehicle has no rear seat.
- The rear seat in my vehicle cannot accommodate a rear-facing infant seat.
- The infant has a medical condition which, according to the infant's physician, makes it necessary for the infant to ride in the front seat so that the driver can monitor the infant's condition.

2. **Children age 12 or under:** Children age 12 or under must ride in the front seat because:

- The vehicle has no rear seat.
- Although children age 12 and under ride in the rear seat whenever possible, children age 12 and under have no option but to sometimes ride in the front seat because rear seat space is insufficient.
- The child has a medical condition that, according to the child's physician, makes it necessary for the child to ride in the front seat so that the driver can monitor the child's condition.

3. **Medical condition:** A passenger has a medical condition that, according to his or her physician:

- Poses a special risk for the passenger if the airbag deploys.
- Makes the potential harm from the passenger airbag deployment greater than the potential harm from turning off the airbag and experiencing a crash without the protection offered by the airbag.

PROPERLY ADJUSTING THE DRIVER AND FRONT PASSENGER SEATS



WARNING: National Highway Traffic Safety Administration (NHTSA) recommends a minimum distance of at least 10 in (25 cm) between an occupant's chest and the driver airbag module.

To properly position yourself away from the airbag:

- Move your seat to the rear as far as you can while still reaching the pedals comfortably.
- Recline the seat slightly one or two degrees from the upright position.

After all occupants have adjusted their seats and put on seatbelts, it is very important that they continue to sit properly. Properly seated occupants sit upright, lean against the seat backrest, and center themselves on the seat cushion, with their feet comfortably extended on the floor. Sitting improperly can increase the chance of injury in a crash event. For example, if an occupant slouches, lies down, turns sideways, sits forward, leans forward or sideways, or puts one or both feet up, the chance of injury during a crash greatly increases.

CHILDREN AND AIRBAGS



WARNING: Do not place a rearward facing child restraint in front of an active airbag. Failure to follow this instruction could result in personal injury or death.

Airbags



Children must always be properly restrained. Accident statistics suggest that children are safer when properly restrained in the rear seating positions than in the front seating position. Failure to follow these instructions may increase the risk of injury in a crash.

If two adults and a child occupy a vehicle without rear seats, properly restrain the child in the center front seat unless doing so would interfere with driving your vehicle. This provides lap and shoulder belt protection for all occupants, and airbag protection for the adults. A child or infant properly restrained in the center front seat should have a reduced risk to serious injury from the airbags.

CRASH SENSORS AND AIRBAG INDICATOR



WARNING: Modifying or adding equipment to the front of your vehicle could affect the performance of the airbag system, increasing the risk of injury. This includes the hood, bumper system, frame, front body structure, tow hooks, hood pins, push bar and snowplows.

Your vehicle is equipped with multiple crash and occupant sensors. These sensors provide information to the restraints control module which activates the following:

- Front and rear seatbelt pretensioners.
- Driver airbag.
- Passenger airbag.
- Seat mounted side airbags.
- Safety Canopy.

Based on the type of crash, the restraints control module which, in the event of a crash, activates the following:

The restraints control module also monitors the readiness of the above safety devices plus the crash and occupant sensors. The readiness of the safety system is indicated by a warning indicator in the instrument cluster or by a backup tone if the warning indicator is not working. Routine maintenance of the airbag is not required.

A difficulty with the system is indicated by one or more of the following:



The readiness light will not illuminate immediately after you switch the ignition on.

- The readiness light either flashes or stays on.
- You hear a series of five tones. The tone pattern repeats periodically until the problem, the light or both are repaired.

If any of these things happen, even intermittently, have the supplemental restraint system serviced immediately. Unless serviced, the system may not function properly in the event of a crash.

Airbags

The fact the seatbelt pretensioners or front airbags did not activate for both front seat occupants in a crash does not mean that something is wrong with the system. Rather, it means the restraints control module determined the accident conditions (crash severity, seatbelt usage) were not appropriate to activate these safety devices.

- The front airbags activate only in frontal and near-frontal crashes. Front airbags may activate in rollovers, side impacts or rear impacts if the crash causes sufficient frontal deceleration.
- The seatbelt pretensioners activate in frontal, near-frontal and side crashes, and in rollovers.
- The side airbags inflate in certain side impact crashes or rollover events. Side airbags may activate in other types of crashes if the vehicle experiences sufficient sideways motion or deformation.
- The Safety Canopy inflates in certain side impact crashes or rollover events. The Safety Canopy may activate in other types of crashes if the vehicle experiences sufficient sideways motion or deformation, or a certain likelihood of rollover.

DISPOSING OF AIRBAGS

Contact your authorized dealer as soon as possible. Airbags must be disposed of by qualified personnel.

Pedestrian Alert System

WHAT IS THE PEDESTRIAN ALERT SYSTEM

Electric drive vehicles can be extremely

quiet. The pedestrian alert system is designed to generate a sound to alert pedestrians to the presence of an electric drive vehicle.

PEDESTRIAN ALERT SYSTEM – TROUBLESHOOTING

PEDESTRIAN ALERT SYSTEM – INFORMATION MESSAGES

Message	Condition	Action
Pedestrian Sounder Fault Service Now	The system has malfunctioned.	Have your vehicle checked as soon as possible.

911 Assist

WHAT IS 911 ASSIST

911 Assist is a SYNC system feature that can call for help.

For more information, visit www.owner.ford.com.

HOW DOES 911 ASSIST WORK - GASOLINE

If a crash deploys an airbag, excluding knee airbags and rear inflatable seatbelts, or activates the fuel pump shut-off, your vehicle may be able to contact emergency services by dialing 911 through a paired and connected **Bluetooth**® enabled phone.

Not all crashes deploy an airbag or activate the fuel pump shut-off. If a connected cell phone sustains damage or loses its connection to SYNC during a crash, SYNC searches for and tries to connect to a previously paired cell phone. SYNC then attempts to call the emergency services.

Before making the call:

- SYNC provides about 10 seconds to cancel the call. If you fail to cancel the call, SYNC attempts to dial 911.
- SYNC says the following, or a similar message: SYNC will attempt to call 911, to cancel the call, press Cancel on your screen or press and hold the phone button on your steering wheel.

If you do not cancel the call and SYNC makes a successful call a pre-recorded message plays for the 911 operator. The occupants in your vehicle are able to talk with the operator. Be prepared to provide your name, phone number and location immediately because not all 911 systems are capable of receiving this information electronically.

During an emergency call the system transmits vehicle data to the emergency service.

HOW DOES 911 ASSIST WORK - BATTERY ELECTRIC VEHICLE

If a crash deploys an airbag, excluding knee airbags and rear inflatable seatbelts, or activates the battery shut-off, your vehicle may be able to contact emergency services by dialing 911 through a paired and connected **Bluetooth**®-enabled phone.

Not all crashes will deploy an airbag or activate the battery shut-off. If a connected cell phone sustains damage or loses its connection to SYNC during a crash, SYNC will search for and try to connect to a previously paired cell phone. SYNC will then attempt to call the emergency services.

Before making the call:

- SYNC provides about 10 seconds to cancel the call. If you fail to cancel the call, SYNC attempts to dial 911.
- SYNC says the following, or a similar message: "SYNC will attempt to call 911, to cancel the call, press Cancel on your screen or press and hold the phone button on your steering wheel."

If you do not cancel the call and SYNC makes a successful call a pre-recorded message plays for the 911 operator. The occupants in your vehicle are able to talk with the operator. Be prepared to provide your name, phone number and location immediately because not all 911 systems are capable of receiving this information electronically.

During an emergency call the system transmits vehicle data to the emergency service.

911 Assist

EMERGENCY CALL REQUIREMENTS



WARNING: Do not wait for 911 Assist to make an emergency call if you can do it yourself. Dial emergency services immediately to avoid delayed response time which could increase the risk of serious injury or death after a crash. If you do not hear 911 Assist within five seconds of the crash, the system or phone may be damaged or non-functional.



WARNING: Always place your phone in a secure location in your vehicle so it does not become a projectile or get damaged in a crash. Failure to do so may cause serious injury to someone or damage the phone which could prevent 911 Assist from working properly.



WARNING: Unless the 911 Assist setting is set on before a crash, the system will not dial for help which could delay response time, potentially increasing the risk of serious injury or death after a crash.

- SYNC must be powered and working properly at the time of the incident and throughout feature activation and use.
- The 911 Assist feature must be set on before the incident.
- You must pair and connect a **Bluetooth®** enabled and compatible cell phone to SYNC.
- A connected **Bluetooth®** enabled phone must have the ability to make and maintain an outgoing call at the time of the incident.

- A connected **Bluetooth®** enabled phone must have adequate network coverage, battery power and signal strength.
- The vehicle must have battery power and be located in the U.S., Canada or in a territory in which 911 is the emergency number.

Note: *If any user sets 911 Assist to on or off, that setting applies for all paired phones. If 911 Assist is switched off and the phone is connected to SYNC, an icon displays on the status bar.*

Note: *Every phone operates differently. While SYNC 911 Assist works with most cellular phones, some may have trouble using this feature.*

EMERGENCY CALL LIMITATIONS

The SYNC 911 Assist feature only operates in the U.S., Canada or in a territory in which 911 is the emergency number.

- Your cellular phone or 911 Assist hardware sustains damage in a crash.
- The vehicle's battery or the SYNC system has no power.
- The phone(s) thrown from your vehicle are the ones paired and connected to the system.

Keys and Remote Controls

REMOTE CONTROL LIMITATIONS



WARNING: Changes or modifications not expressly approved by the party responsible for compliance could void the user's authority to operate the equipment. The term "IC:" before the radio certification number only signifies that Industry Canada technical specifications were met.

This device complies with Part 15 of the FCC Rules and with Industry Canada license-exempt RSS standard(s). Operation is subject to the following two conditions: (1) This device may not cause harmful interference, and (2) This device must accept any interference received, including interference that may cause undesired operation.

Make sure a valid remote control is within 3 ft (1 m) from the front door handles and rear of vehicle.

The system may not function if:

- The remote control remains stationary for about a minute.
- The vehicle battery has no charge.
- The remote control battery has no charge.
- There is interference causing issues with the remote control frequencies.
- The remote control is too close to metal objects or electronic devices, for example keys or a cell phone.

OPENING AND CLOSING THE FLIP KEY



Press the button to release the key. Press and hold the button to fold the key back when not in use.

REMOVING THE KEY BLADE - VEHICLES WITH: PUSH BUTTON START



Push the release button and pull the key blade out.

Keys and Remote Controls

SOUNDING THE PANIC ALARM



Press the button to sound the panic alarm. Press the button again or switch the vehicle on to turn it off.

Note: The panic alarm only operates when the vehicle is off.

LOCATING YOUR VEHICLE



Press the lock button on the key twice within three seconds. The direction indicators will flash.

CHANGING THE REMOTE CONTROL BATTERY - VEHICLES WITH: KEYED IGNITION



WARNING: Keep batteries away from children to prevent ingestion. Failure to follow this instruction could result in personal injury or death. If ingested, immediately seek medical attention.



WARNING: If the battery compartment does not securely close, stop using the remote control and replace it as soon as possible. In the meantime, keep the remote control away from children. Failure to follow this instruction could result in personal injury or death.



CAUTION: The battery can cause severe or fatal injuries in two hours or less if swallowed or placed inside any part of the body. Seek medical attention immediately.



Make sure that you dispose of old batteries in an environmentally friendly way. Seek advice from your local authority about recycling old batteries.

The remote control uses one coin-type three-volt lithium battery CR2032 or equivalent.

1. Press the key release button.



2. Insert a suitable tool, for example a screwdriver, in the position shown and gently push the clip.
3. Press the clip down to release the battery cover.

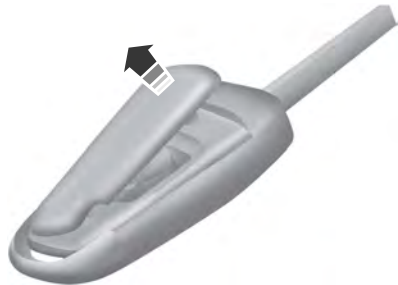

4. Carefully remove the cover.

Keys and Remote Controls



5. Insert a screwdriver as shown to release the battery.

Note: Do not touch the battery contacts or the printed circuit board with the screwdriver.



6. Remove the battery.
7. Install a new battery with the + facing upward.
8. Replace the battery cover.

CHANGING THE REMOTE CONTROL BATTERY - VEHICLES WITH: PUSH BUTTON START

 **WARNING:** Keep batteries away from children to prevent ingestion. Failure to follow this instruction could result in personal injury or death. If ingested, immediately seek medical attention.

 **WARNING:** If the battery compartment does not securely close, stop using the remote control and replace it as soon as possible. In the meantime, keep the remote control away from children. Failure to follow this instruction could result in personal injury or death.



CAUTION: The battery can cause severe or fatal injuries in two hours or less if swallowed or placed inside any part of the body. Seek medical attention immediately.



Make sure that you dispose of old batteries in an environmentally friendly way. Seek advice from your local authority about recycling old batteries.

The remote control uses one coin-type three-volt lithium battery CR2450 or equivalent.

Keys and Remote Controls



1. Push the release button and pull the key blade out.



2. Twist a thin coin under the tab hidden behind the key blade head to remove the battery cover.

Keys and Remote Controls

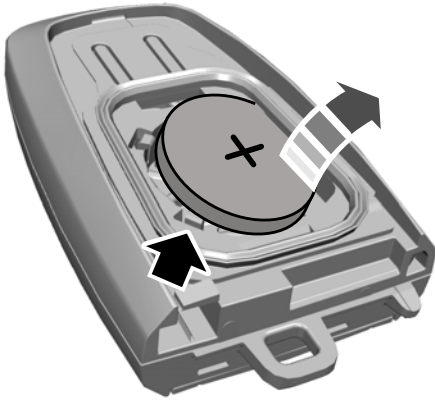

3. Insert a suitable tool, for example a screwdriver, in the position shown and carefully remove the battery.
4. Install a new battery with the + facing upward.

Note: Do not wipe off any grease on the battery terminals or on the back surface of the circuit board.

5. Reinstall the battery cover and the key blade.

REPLACING A LOST KEY OR REMOTE CONTROL

You can purchase replacement keys or remote controls from an authorized dealer. If possible, provide them with the key number from the tag provided with the original key. You can also obtain extra keys.

PROGRAMMING THE REMOTE CONTROL

Contact an authorized dealer to program remote controls for your vehicle.

KEYS AND REMOTE CONTROLS AUDIBLE WARNINGS - VEHICLES WITH: KEYED IGNITION

Sounds when you open the driver's door, turn off the vehicle and you have left the key in the ignition.

KEYS AND REMOTE CONTROLS AUDIBLE WARNINGS - VEHICLES WITH: PUSH BUTTON START

Key In Reminder

Sounds when the following conditions are met:

- Vehicle is out of park (P).
- You switch the vehicle off.
- You open the driver's door.
- You have left the key inside the vehicle.

Keys and Remote Controls

KEYS AND REMOTE CONTROLS – TROUBLESHOOTING

KEYS AND REMOTE CONTROLS – INFORMATION MESSAGES

Message	Details
Key Battery Low Replace Soon	Displays when the remote control battery requires replacing.

FREQUENTLY ASKED QUESTIONS

Question	Answer
What is the fan noise I hear when I press the unlock button on the remote control?	This is the blower motor pushing fresh air into the cabin and out through cabin exhaust vents. Your vehicle has air purge that could turn on when you press the unlock button on the remote control or when certain conditions are met.

WHAT IS MYKEY

MyKey allows you to program keys with restricted settings to promote good driving habits.

MYKEY SETTINGS

NON-CONFIGURABLE MYKEY SETTINGS

Seatbelt Reminder or Belt-Minder™

MyKey mutes the audio system until the front seat belts are buckled.

Note: *If your vehicle includes an AM/FM radio or a very basic audio system, then the radio may not mute.*

Satellite Radio (If Equipped)

Some Satellite radio channels have restricted access to adult radio content.

Driving and Parking Aids

Settings for parking aids, blind spot information system, and cross traffic alert cannot be configured. These systems turn on when the vehicle turns on and cannot be switched off with a MyKey.

Settings for pre-collision assist and lane keeping cannot be configured. These systems turn on when the vehicle turns on but can be switched off with a MyKey.

A new destination in the navigation system can only be set using voice commands when using a MyKey, and with your vehicle moving.

Note: *MyKey drivers may be able to turn the lane departure warning feature off, but this feature turns back on automatically with every new key cycle.*

CONFIGURABLE MYKEY SETTINGS

You can configure the following settings after creating a MyKey. See **Creating a MyKey** (page 80).

Speed Limit



WARNING: Do not set MyKey maximum speed limit to a limit that will prevent the driver from maintaining a safe speed considering posted speed limits and prevailing road conditions. The driver is always responsible to drive in accordance with local laws and prevailing conditions. Failure to do so could result in accident or injury.

You can set a speed limit for your vehicle. Warning messages appear in the information display and a tone sounds if your vehicle reaches the set speed. You cannot override the set speed when using a MyKey.

Speed Reminder

You can set a speed reminder for your vehicle. Warning messages appear in the information display and a tone sounds if your vehicle exceeds the set speed.

Audio System Volume Limit

The audio system maximum volume is reduced. A message appears in the information display if you attempt to exceed the volume limit. Automatic volume control turns off.

Emergency Assistance

If you set emergency assistance to be always on, it cannot be switched off with a MyKey.

Do Not Disturb

If you set do not disturb to be always on, it cannot be switched off with a MyKey.

Traction and Stability Control

If you set traction control or stability control to be always on, you cannot switch it off with a MyKey.

CREATING A MYKEY - VEHICLES WITH: KEYED IGNITION

1. Switch the ignition on using an admin key.
2. Using the information display controls on the steering wheel, select **Settings**.
3. Select **MyKey**.
4. Select **Create MyKey**.
5. Press and hold the **OK** button until a confirmation message appears in the information display.
6. Switch the ignition off.

Note: We recommend that you label this key.

CREATING A MYKEY - VEHICLES WITH: PUSH BUTTON START

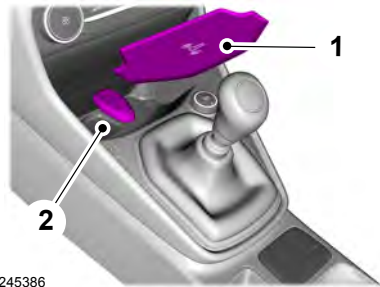

1. Remove the rubber mat.
2. Place the admin key in the position shown, with the buttons facing upward.
3. Switch the ignition on.
4. Using the information display controls on the steering wheel, select **Settings**.
5. Select **MyKey**.
6. Select **Create MyKey**.
7. Press and hold the **OK** button until a confirmation message appears in the information display.
8. Switch the ignition off.

Note: We recommend that you label this key.

PROGRAMMING A MYKEY

You can only program MyKeys to the same settings.

1. Switch the ignition on using an admin key.
2. Using the information display controls on the steering wheel, select **Settings**.
3. Select **MyKey**.

4. Select a setting and press the **OK** button.
5. Configure the setting.
6. Switch the ignition off.

CLEARING ALL MYKEYS

When you clear all MyKeys, you remove all restrictions and return all MyKeys to their original admin key status.

1. Switch the ignition on using an admin key.
2. Using the information display controls on the steering wheel, select **Settings**.
3. Select **MyKey**.
4. Select **Clear MyKeys**.
5. Press and hold the **OK** button until a confirmation message appears in the information display.

MYKEY – TROUBLESHOOTING

MYKEY – INFORMATION MESSAGES - VEHICLES WITH: KEYED IGNITION

Message	Details
The key is already a MyKey.	Displays when trying to create a MyKey with a key already designated as a MyKey.
MyKey will be enabled at the next key cycle. Please label the key as a MyKey.	Displays to confirm that the key is restricted after you switch the ignition off.

CHECKING MYKEY SYSTEM STATUS

You can find information about the distance traveled using a MyKey and also the number of admin keys and MyKeys created for your vehicle.

1. Switch the ignition on.
2. Using the information display controls on the steering wheel, select **Settings**.
3. Select **MyKey**.
4. Select **MyKey Info**.

USING MYKEY WITH REMOTE START SYSTEMS

The system is not compatible with non-Ford remote start systems.

MYKEY – INFORMATION MESSAGES - VEHICLES WITH: PUSH BUTTON START

Message	Details
To create a MyKey, please place the key in the backup location.	Displays when trying to create a MyKey and the admin key is not placed in the backup position. See Creating a MyKey (page 80). See Creating a MyKey (page 80).
The key is already a MyKey.	Displays when trying to create a MyKey with a key already designated as a MyKey.
MyKey will be enabled at the next key cycle. Please label the key as a MyKey.	Displays to confirm that the key is restricted after you switch the ignition off.

MYKEY – FREQUENTLY ASKED QUESTIONS - VEHICLES WITH: KEYED IGNITION

What is an admin key?

- An admin key is a key that has not been created as a MyKey. See **Creating a MyKey** (page 80).

Why can I not create a MyKey?

- The key used to switch the ignition on is not an admin key.
- The key used to switch the ignition on is the only admin key. There always has to be at least one admin key.

Why can I not program a MyKey?

- The key used to switch the ignition on is not an admin key.
- No MyKeys are created. See **Creating a MyKey** (page 80).

Why can I not clear the MyKeys?

- The key used to switch the ignition on is not an admin key.
- No MyKeys are created. See **Creating a MyKey** (page 80).

Why does the MyKey distance not accumulate?

- The key used to start the engine is an admin key.
- No MyKeys are created. See **Creating a MyKey** (page 80).
- The MyKeys have been cleared.

MYKEY – FREQUENTLY ASKED QUESTIONS - VEHICLES WITH: PUSH BUTTON START

What is an admin key?

- An admin key is a key that has not been created as a MyKey. See **Creating a MyKey** (page 80).

Why can I not create a MyKey?

- The admin key is not placed in the backup position. See **Creating a MyKey** (page 80).
- The key used to switch the ignition on is not an admin key.
- The key used to switch the ignition on is the only admin key. There always has to be at least one admin key.
- The last MyKey was created without switching the ignition off.

Why can I not program a MyKey?

- The admin key is not inside your vehicle.
- The key used to switch the ignition on is not an admin key.
- No MyKeys are created. See **Creating a MyKey** (page 80).

Why can I not clear the MyKeys?

- The admin key is not inside your vehicle.
- The key used to switch the ignition on is not an admin key.
- No MyKeys are created. See **Creating a MyKey** (page 80).

Why does the MyKey distance not accumulate?

- The key used to start the engine is an admin key.
- An admin key and a MyKey are inside your vehicle.
- No MyKeys are created. See **Creating a MyKey** (page 80).
- The MyKeys have been cleared.

Why can I not start the engine with a MyKey?

- An admin key and a MyKey are inside your vehicle.

Doors and Locks

OPERATING THE DOORS FROM OUTSIDE YOUR VEHICLE

UNLOCKING AND LOCKING THE DOORS USING THE REMOTE CONTROL

You can only use the remote control when your vehicle is stationary.

Unlocking the Doors



Press the button to unlock all doors. One long flash of the turn signal lamps confirms that your vehicle has unlocked.

Locking the Doors



Press the button to lock all doors. One short flash of the turn signal lamps confirms that your vehicle has locked.

Note: For more information on operating the doors from outside your vehicle See **Keyless Entry** (page 93).

UNLOCKING AND LOCKING THE DOORS USING THE KEY BLADE

Unlocking the Doors

1. Release the key blade from the remote control.
2. Fully insert the key into the driver door lock cylinder.
3. Turn the top of the key toward the front of your vehicle.

Locking the Doors

1. Release the key blade from the remote control.
2. Fully insert the key into the driver door lock cylinder.

3. Turn the top of the key toward the rear of your vehicle.

OPENING AND CLOSING THE DOORS

Opening the Double Rear Doors



E148805

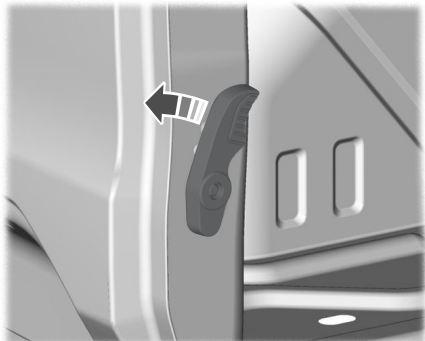

E148806

Doors and Locks

Fully Opening the Double Rear Doors

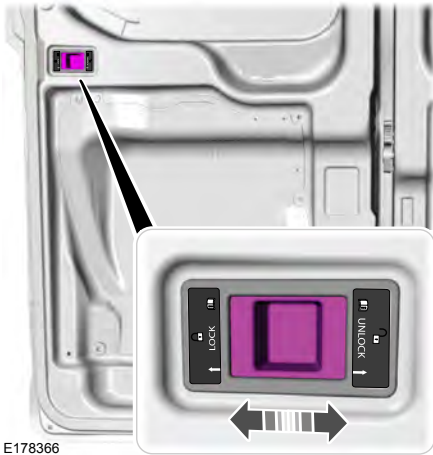

E178366

1. Slide the switch to release the catch.
2. Fully open the cargo door.

Note: If you open the rear doors the rear lights might be covered. Make sure the vehicle is visible from the rear in compliance with local regulations, for example use a warning triangle if necessary.

Central position

You can open the rear door up to 90° when the switch is in the central position.

Lock position



Open the door at 90°, slide the switch to the lock position to stop the door from closing accidentally. Slide the switch back to the central position to close the door, or to the unlock position to fully open it.

Unlock position



Open the door at 90°, slide and hold the switch at the unlock position to fully open the rear door.

Note: Do not place heavy items against the door when the door is open, to avoid causing damage to the hinges or lock system.

OPERATING THE DOORS FROM INSIDE YOUR VEHICLE

UNLOCKING AND LOCKING THE DOORS USING THE CENTRAL LOCKING

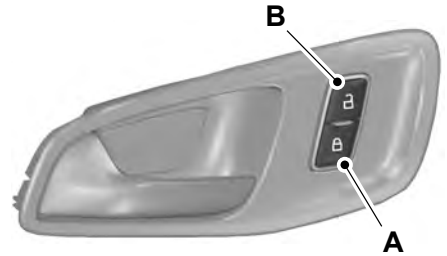

E148829

- A Lock
- B Unlock

You can see the door lock status in the instrument panel. The lamp will illuminate when you lock your vehicle.

Doors and Locks

OPENING THE REAR DOORS FROM INSIDE YOUR VEHICLE IN AN EMERGENCY

Wagon and Bus

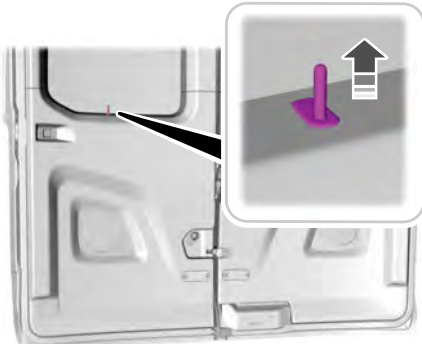

E236264

1. Lift the locking button up.

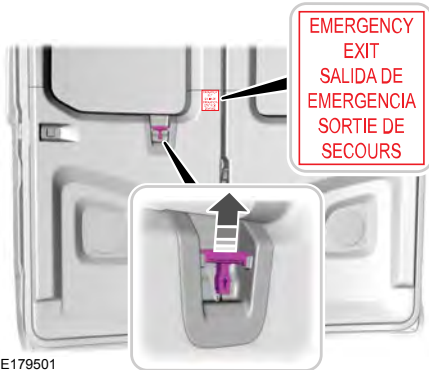

E179501

2. Pull the interior handle up to open the door in an emergency.

OPENING THE DOORS FROM INSIDE YOUR VEHICLE

Double Rear Door

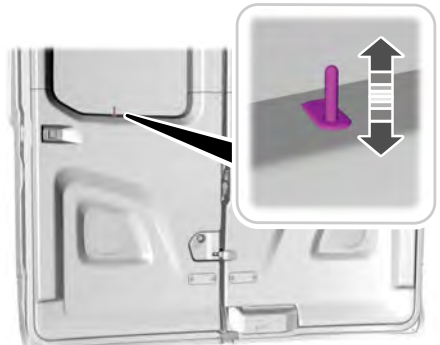

E175828

1. Lift the locking button up.

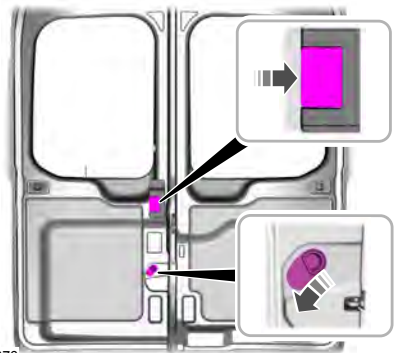

E255876

2. Pull the upper release lever toward you or slide the lower release lever downward to open the door.

Doors and Locks

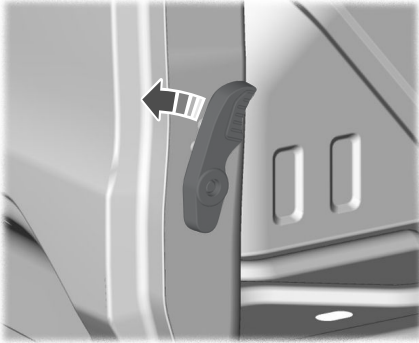

E148806

3. Pull the release lever to open the other door.

REPROGRAMMING THE UNLOCKING FUNCTION

You can program the unlocking function so that only the driver door, or cabin door unlocks.

Press and hold the unlock and lock buttons on the remote control simultaneously for at least four seconds with the ignition off. The direction indicators flash twice to confirm the change.

To return to the original unlocking function, repeat the process.

If you program the unlocking function so that only the driver door, or cabin door unlocks, the following occurs:

- If you unlock the driver door, or cabin door first, all other doors remain locked. You can unlock all of the other doors from inside your vehicle using the power door lock control on the driver door or cabin door. Doors can be individually unlocked by pulling the interior door handles on those doors.
- If you press the unlocking button on the remote control once, only the driver door, or cabin door unlocks. Press the unlocking button on the remote control twice within three seconds to unlock all doors.
- If you unlock any other door first, all other doors and the liftgate unlock.

Note: Depending on the locking mechanism, you can program the unlocking function to unlock the driver door or the cabin doors.

You can also change between the unlocking modes in the information display.

1. Using the information display controls on the steering wheel, select **Settings**.
2. Select **Vehicle Settings**.
3. Select **Locks**.
4. Select **Remote Unlock**.
5. Select **All Doors** or **Driver's Door**.

AUTOUNLOCK

WHAT IS AUTOUNLOCK

Autounlock is a feature that centrally unlocks the vehicle doors when your vehicle comes to a stop and you open the driver door.

Doors and Locks

AUTOUNLOCK REQUIREMENTS

Autounlock unlocks all the doors after:

1. The vehicle speed exceeds 12 mph (20 km/h).
2. Your vehicle comes to a stop.
3. You open the driver door.

Note: *Autounlock operates for only 10 minutes after the ignition is switched off.*

SWITCHING AUTOUNLOCK ON AND OFF - VEHICLES WITH: SYNC 3 LITE, VEHICLES WITHOUT: SYNC

1. Using the information display controls on the steering wheel, select **Settings**.
2. Select **Vehicle Settings**.
3. Select **Locks**.
4. Switch **Autounlock** on or off.

SWITCHING AUTOUNLOCK ON AND OFF - VEHICLES WITH: SYNC 4

1. Press **Settings** on the touchscreen.
2. Press **Vehicle**.
3. Press **Locks**.
4. Switch **Autounlock** on or off.

AUTOLOCK (IF EQUIPPED)

WHAT IS AUTOLOCK

Autolock is a locking feature that locks the vehicle doors when you start driving.

AUTOLOCK REQUIREMENTS

Autolock locks all the doors after:

1. All doors are closed and the ignition is on.
2. Your vehicle speed exceeds 12 mph (20 km/h).

Autolock repeats if:

1. Your vehicle is stopped.
2. Any door is opened and closed again.
3. Your vehicle speed exceeds 12 mph (20 km/h).

AUTORELOCK (IF EQUIPPED)

HOW DOES AUTORELOCK WORK

The doors automatically relock if you do not open a door within 45 seconds of unlocking the doors with the remote control. The doors lock and the alarm return to its previous state.

DOORS AND LOCKS AUDIBLE WARNINGS

Door Ajar Audible Warning

Sounds when any door is not fully closed and your vehicle is moving.

DOORS AND LOCKS – TROUBLESHOOTING

DOORS AND LOCKS – WARNING LAMPS

Door Ajar Warning Lamp



Illuminates when you switch the ignition on and remains on if any door or the hood is open.

Doors and Locks

DOORS AND LOCKS – INFORMATION MESSAGES

Message	Details
Driver Door Ajar	Displays if a door is open. Fully close the door.
Passenger Door Ajar	
Rear Left Door Ajar	
Rear Right Door Ajar	
Hood Ajar	Displays if a hood is open. Fully close the hood.

Sliding Door

SLIDING DOOR PRECAUTIONS



WARNING: Fully close the sliding door before driving, to prevent passengers and cargo from falling out. Failure to follow this instruction could result in personal injury or death.



WARNING: Do not open or close the sliding door when your hands are near the tracks or rollers. Failure to follow this instruction could result in personal injury.

Note: When opening the sliding door make sure you fully open it until you hear a click. This way the door stop engage can protect you from accidentally closing.

Note: Do not leave the sliding door open when you are driving. This could damage the sliding door and its components.

OPENING THE SLIDING DOOR

OPENING THE SLIDING DOOR FROM INSIDE YOUR VEHICLE

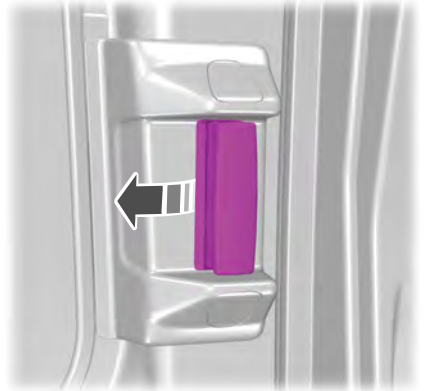

Pull the interior door handle to open the sliding door.

OPENING THE SLIDING DOOR FROM OUTSIDE YOUR VEHICLE

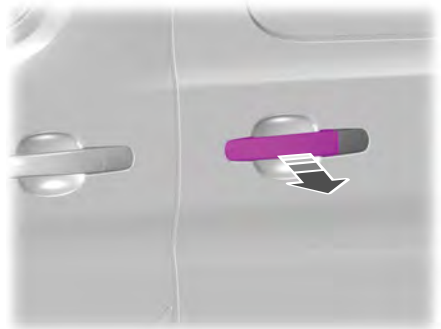

Sliding Door

Pull the exterior door handle to open the sliding door.

CLOSING THE SLIDING DOOR FROM OUTSIDE YOUR VEHICLE

CLOSING THE SLIDING DOOR

CLOSING THE SLIDING DOOR FROM INSIDE YOUR VEHICLE

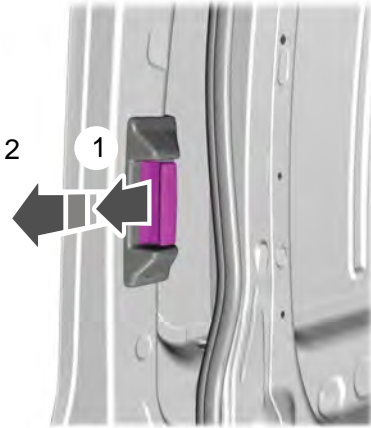

1. Pull the interior door handle to release the door check feature.
2. Slide the door to close.

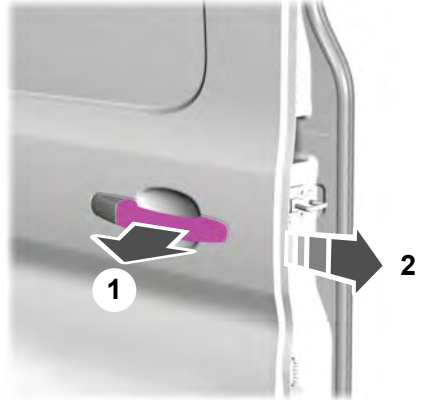

1. Pull the exterior door handle to release the door check feature.
2. Slide the door to close.

Keyless Entry

WHAT IS KEYLESS ENTRY

The system allows you to lock and unlock your vehicle without taking the passive key out of your pocket or purse.

KEYLESS ENTRY LIMITATIONS

Make sure your remote control is within 3 ft (1 m) from the front door handles and the tailgate.

The system could not function if:

- The remote control remains stationary for about a minute.
- The vehicle battery has no charge.
- The remote control battery has no charge.
- There is interference causing issues with the remote control frequencies.
- The remote control is too close to metal objects or electronic devices, for example keys or a cell phone.

KEYLESS ENTRY SETTINGS

Switching Keyless Entry On and Off

1. Using the instrument cluster controls on the steering wheel, select **Settings**.
2. Select **Vehicle Settings**.
3. Select **Locks**.
4. Switch **Intelligent Access** on or off.

Reprogramming the Unlocking Function

You can program the unlocking function so that only the driver door unlocks when you touch the unlock sensor on the exterior door handle.

If you program the unlocking function so that only the driver door unlocks, the following occurs:

- If you open the driver door first, all other doors remain locked. You can unlock all of the other doors from inside your vehicle using the power door lock control on the driver door. You can unlock individual doors by pulling the interior door handles on those doors.
- If you open any other door first, all other doors unlock.

You can change between the unlocking modes in the information display.

1. Using the instrument cluster controls on the steering wheel, select **Settings**.
2. Select **Vehicle Settings**.
3. Select **Locks**.
4. Select **Remote Unlock**.
5. Select **All Doors** or **Driver's Door**.

USING KEYLESS ENTRY

Unlocking the Doors

Unlock sensors are on the back of the exterior front door handles.

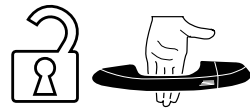

Touch the unlock sensor to unlock your vehicle and disarm the alarm. The direction indicators flash. Do not touch the lock sensor on the outer surface of the door handle.

Keep the door handle clean to make sure the system correctly operates.

Keyless Entry

After unlocking the doors with the unlock sensor, there is a brief delay before you can lock your vehicle. When the delay period is over, you can lock the doors again, provided the passive key is within the respective detection range.

Locking the Doors

Lock sensors are on the top of the exterior front door handles.



Touch a lock sensor once to lock your vehicle and arm the alarm. The direction indicators flash.

Keep the door handle clean to make sure the system correctly operates.

Note: *Your vehicle does not automatically lock. If you do not touch a lock sensor your vehicle remains unlocked.*

After locking the doors with the lock sensor, there is a brief delay before you can unlock your vehicle. This delay lets you pull the handle to make sure your vehicle is locked. When the delay period is over, you can unlock the doors again, provided the passive key is within the respective detection range.

KEYLESS ENTRY – TROUBLESHOOTING

KEYLESS ENTRY – FREQUENTLY ASKED QUESTIONS

Why does the keyless entry system not function?

- If the system does not function it may be limited. See **Keyless Entry Limitations** (page 93). If the system still does not function use the remote control or the key blade to lock and unlock your vehicle.

Why can I not lock my vehicle?

- If you electronically lock your vehicle with a rear door or the liftgate open, the system searches for a passive key inside your vehicle after you close the last door. If the system detects a key, all doors unlock indicating that a key is inside. Your vehicle locks if another passive key is within the detection range after you close the last door.

Why does the passive key not work?

- The system deactivates passive keys left inside your vehicle when you lock it. You cannot switch the ignition on using a deactivated passive key. Press the unlock button on the remote control to reactivate a passive key.

Keyless Entry Keypad

WHAT IS THE KEYLESS ENTRY KEYPAD

The keyless entry keypad allows you to lock and unlock your vehicle using the keypad under the driver door window.

KEYLESS ENTRY KEYPAD LIMITATIONS

The system may not function if:

- The vehicle battery has no charge.

LOCATING THE KEYLESS ENTRY KEYPAD



The keypad is under the driver door window. It may illuminate when you press a button.

KEYLESS ENTRY KEYPAD MASTER ACCESS CODE

The master access code is a factory-set five-digit entry code. You can operate the keypad with the master access code at any time.

KEYLESS ENTRY KEYPAD PERSONAL ACCESS CODES

Reprogramming the Unlocking Function

You can program the unlocking function so that only the driver door, or cabin door unlocks.

Note: *Depending on the locking mechanism, you can program the unlocking function to unlock the driver door or the cabin doors.*

Press and hold the unlock and lock buttons on the remote control simultaneously for at least four seconds with the ignition off. The direction indicators flash twice to confirm the change.

To return to the original unlocking function, repeat the process.

You can also change between the unlocking modes in the instrument cluster display.

1. Using the information display controls on the steering wheel, select **Settings**.
2. Select **Vehicle Settings**.
3. Select **Locks**.
4. Select **Remote Unlock**.
5. Select **All Doors** or **Driver's Door**.

Creating Personal Access Codes

1. Enter the master access code.

Note: *You can find the master access code on the owner's wallet card or at an authorised dealer.*

2. Within five seconds press and hold the 1-2 button for one second.

Note: *A red light flashes twice.*

3. Enter your personal access code.

Keyless Entry Keypad

Note: Your personal access code must be a five-digit code. You must enter each number within five seconds of each other.

The doors unlock, lock and then unlock and the red light flashes twice to confirm that a personal access code has been created.

Clearing All Personal Access Codes

1. Enter the master access code.
2. Within five seconds press and hold the 1-2 button for five seconds.

USING THE KEYLESS ENTRY KEYPAD

Unlocking the Doors

Enter the master access code or your personal access code to unlock the driver door or cabin door, then press the 3-4 button within five seconds to unlock all doors.

Note: If you program the unlocking function so that all doors unlock, you do not have to press the 3-4 button. See **Reprogramming the Unlocking Function** (page 88).

The interior lamps illuminate to confirm that the doors have been unlocked.

Note: Depending on the locking mechanism, you can program the unlocking function to unlock the driver door or the cabin doors.

Unlocking the Rear Cargo Doors

Enter the master access code or your personal access code, then press the 5-6 button within five seconds.

Locking the Doors

Press and hold the 7-8 and 9-0 buttons at the same time with the driver door, or cabin door closed.

Note: Depending on the locking mechanism, you can program the unlocking function to unlock the driver door or the cabin doors.

KEYLESS ENTRY KEYPAD – TROUBLESHOOTING

KEYLESS ENTRY KEYPAD – FREQUENTLY ASKED QUESTIONS

Why does the keypad not accept the access code?

If you enter the access code too fast on the keypad, the unlock function may not work. Slowly re-enter the access code.

Why does the keypad not function?

The keypad goes into an anti-scan mode if you enter a wrong code seven times. The anti-scan mode disables the keypad for one minute and the red light flashes.

Security

PASSIVE ANTI-THEFT SYSTEM

WHAT IS THE PASSIVE ANTI-THEFT SYSTEM

The passive anti-theft system prevents someone from starting the vehicle with an incorrectly coded key.

Note: *The system is not compatible with non-Ford aftermarket remote start systems.*

Note: *Do not leave a duplicate coded key in your vehicle. Always take the keys and lock all doors when leaving your vehicle.*

ARMING THE PASSIVE ANTI-THEFT SYSTEM

The passive anti-theft system arms your vehicle after a short period of time when you switch the power off.

DISARMING THE PASSIVE ANTI-THEFT SYSTEM

The passive anti-theft system disarms when you switch the power on with a correctly coded key.

Note: *You could have difficulty starting the vehicle if you have metallic objects, electronic devices or a second coded key on the same key chain.*

ANTI-THEFT ALARM SYSTEM

WHAT IS THE ANTI-THEFT ALARM SYSTEM

The anti-theft alarm system warns you of an unauthorized entry to your vehicle.

HOW DOES THE ANTI-THEFT ALARM SYSTEM WORK

When armed, the anti-theft alarm is triggered in any of the following ways:

- If someone opens a door, the liftgate or the hood without a correctly coded key or remote control.
- If you turn the power on without a correctly coded key.
- If someone disconnects your vehicle's 12V battery or the battery backup alarm.

If the anti-theft alarm is triggered, the alarm horn sounds for 30 seconds and the turn signals flash for 5 minutes.

Any further attempts to carry out one of the above sounds the alarm again.

WHAT IS THE BATTERY BACKUP ALARM (If Equipped)

The battery backup alarm is an additional alarm sounder that has its own battery. It can detect if your vehicle's 12V battery is disconnected to overcome the alarm system.

ARMING THE ANTI-THEFT ALARM SYSTEM

The alarm is ready to arm when you switch your vehicle off.

Lock your vehicle with your remote control to arm the alarm.

Security

DISARMING THE ANTI-THEFT ALARM SYSTEM

Disarm the alarm by performing any of the following actions:

- Unlock the doors or luggage compartment with the remote control.
- Switch your vehicle on or start your vehicle.

SECURITY – TROUBLESHOOTING

SECURITY – INFORMATION MESSAGES

Message	Details
No Key Detected	The system has not detected a correctly coded key.
Starting System Fault	The system has malfunctioned. Have your vehicle checked as soon as possible.
Vehicle Alarm To Stop Alarm, Start Vehicle.	Displays when the alarm has been triggered due to unauthorized entry.
Alarm	

Security

SECURITY – FREQUENTLY ASKED QUESTIONS

What should I do if there is a potential alarm problem with my vehicle?

- Take all remote controls to an authorized dealer if there is a potential alarm problem with your vehicle.

What should I do if my vehicle is unable to start with a correctly coded key?

- Have your vehicle checked as soon as possible.

Steering Wheel

ADJUSTING THE STEERING WHEEL



WARNING: Do not adjust the steering wheel when your vehicle is moving.

Note: Make sure that you are sitting in the correct position. See **Sitting in the Correct Position** (page 144).

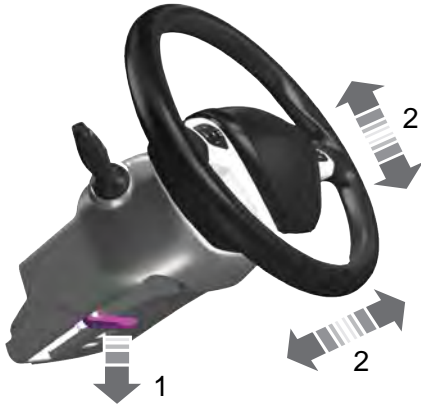

1. Unlock the steering column.
2. Adjust the steering wheel to the desired position.



3. Lock the steering column.

LOCKING THE STEERING WHEEL

1. Remove the key from the ignition.
2. Slightly rotate the steering wheel to engage the lock.

Unlocking the Steering Wheel



WARNING: Always check that the steering is unlocked before attempting to move your vehicle.

1. Insert the key in the ignition.
2. Turn the key to position **I**.

Note: You may have to slightly rotate the steering wheel to assist unlocking it.

Wipers and Washers

WIPERS

WIPER PRECAUTIONS

Fully defrost the windshield before you switch the windshield wipers on.

Make sure that you switch the windshield wipers off before entering a car wash.

If streaks or smears appear on the windshield, clean the windshield and the wiper blades. See **Checking the Wiper Blades** (page 102). If that does not resolve the issue, install new wiper blades. See **Replacing the Front Wiper Blades** (page 102).

Do not operate the wipers on a dry windshield. This may scratch the glass or damage the wiper blades. Always use the windshield washers before wiping a dry windshield.

When your vehicle speed increases, the interval between intermittent wipes may decrease.

SWITCHING WINDSHIELD WIPERS ON AND OFF

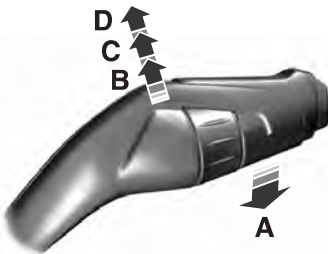

- A Single wipe.
- B Intermittent wipe.

- C Normal wipe.
- D High-speed wipe.

AUTOWIPERS

WHAT ARE AUTOWIPERS

Autowipers turns on and controls the speed and frequency of the windshield wipers.

AUTOWIPERS SETTINGS

1. Using the instrument cluster display controls on the steering wheel, select **Settings**.
2. Select **Vehicle Settings**.
3. Select **Wipers**.
4. Switch **Rain Sensing** on or off.

ADJUSTING THE SENSITIVITY OF THE RAIN SENSOR

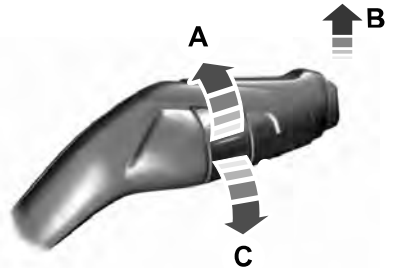

E197526

- A High sensitivity.
- B Autowipers on.
- C Low sensitivity.

Use the rotary control to adjust the sensitivity of the autowipers.

Wipers and Washers

Note: Keep the outside of the windshield clean. The rain sensor is very sensitive and the wipers may operate if dirt, mist or insects hit the windshield.

CHECKING THE WIPER BLADES



Run the tip of your fingers over the edge of the blade to check for roughness.

REPLACING THE FRONT WIPER BLADES

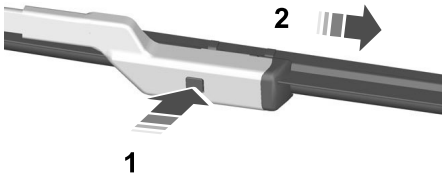

1. Lift the wiper arm. Press the wiper blade locking button.

Note: Do not hold the wiper blade when lifting the wiper arm.

2. Remove the wiper blade

Note: Make sure that the wiper arm does not spring back against the glass when the wiper blade is not attached.

3. To install, reverse the removal procedure.

Note: Make sure that the wiper blade locks into place.

WASHERS

WASHER PRECAUTIONS



WARNING: If you operate your vehicle in temperatures below 41°F (5°C), use washer fluid with antifreeze protection. Failure to use washer fluid with antifreeze protection in cold weather could result in impaired windshield vision and increase the risk of injury or accident.

Do not operate the washers when the washer reservoir is empty. This could cause the washer pump to overheat.

USING THE WINDSHIELD WASHER



Pull the lever toward you to operate the windshield washer.

Note: A courtesy wipe occurs a short time after the wipers stop to clear any remaining washer fluid when switched on. See **Switching the Courtesy Wipe On and Off** (page 103).

Wipers and Washers

SWITCHING THE COURTESY WIPE ON AND OFF

1. Using the instrument cluster display controls on the steering wheel, select **Settings**.
2. Select **Vehicle Settings**.
3. Select **Wipers**.
4. Switch **Courtesy Wipe** on or off.

ADDING WASHER FLUID

1. Open the hood.
2. Remove the washer fluid reservoir cap.
3. Add washer fluid that meets our specification. See **Washer Fluid Specification** (page 467).
4. Install the washer fluid reservoir cap.

Note: *The reservoir supplies the front and rear washer systems.*

WIPERS AND WASHERS – TROUBLESHOOTING

WIPERS AND WASHERS – WARNING LAMPS



Illuminates when the windshield washer fluid is low.

WIPERS AND WASHERS – FREQUENTLY ASKED QUESTIONS

Why are there streaks and smears on the windshield?

- The wiper blades could be dirty, worn or damaged. Check the wiper blades. See **Checking the Wiper Blades** (page 102). If the wiper blades are dirty, clean them with washer fluid or water applied with a soft sponge or cloth. If the wiper blades are worn or damaged, install new ones. See **Replacing the Front Wiper Blades** (page 102).

Exterior Lighting

EXTERIOR LIGHTING CONTROL

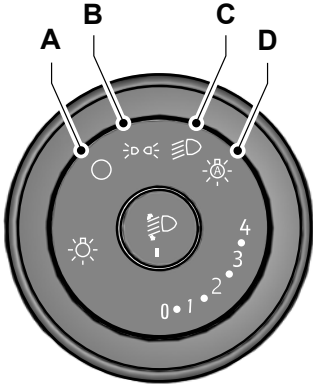

- A Lamps off.
- B Parking lamps, instrument panel lamps and license plate lamps on.
- C Headlamps on.
- D Autolamps on. See **What Are Autolamps** (page 105).

Rotate the control to make a selection.

HEADLAMPS

USING THE HIGH BEAM HEADLAMPS



Push the lever away from you to switch the high beams on.

Push the lever forward again or pull the lever toward you to switch the high beams off.

Slightly pull the lever toward you and release it to flash the headlamps.

Note: *Continuous activation only with headlamps on.*

HEADLAMP INDICATORS

Lamps On



Illuminates when you switch the low beam headlamps or the parking lamps on.

Headlamp High Beam



Illuminates when you switch the high beam headlamps on.

Exterior Lighting

HEADLAMPS – TROUBLESHOOTING

HEADLAMPS – FREQUENTLY ASKED QUESTIONS

Why is there condensation in the headlamps?

- Headlamps have vents to accommodate normal changes in air pressure. Condensation can be a natural by-product of this design. When moist air enters the lamp assembly through the vents, there is a possibility that condensation can occur when the temperature is cold. When normal condensation occurs, a fine mist can form on the interior of the lens. The fine mist eventually clears and exits through the vents during normal operation.

How much condensation is acceptable?

- The presence of a fine mist, for example no streaks, drip marks or large droplets. A fine mist covers less than 50% of the lens.

How long does it take for the acceptable condensation to clear?

- Clearing time can take as long as 48 hours under dry weather conditions.

How much condensation is unacceptable?

- A water puddle inside the lamp. Streaks, drip marks or large droplets present on the interior of the lens.

What should I do if unacceptable condensation is present?

- Have your vehicle checked as soon as possible.

Why do my headlamps turn off when I have them switched on when I switch my vehicle off?

- The battery saver turns the headlamps off after a short period of time after you switch your vehicle off.

AUTOLAMPS

WHAT ARE AUTOLAMPS

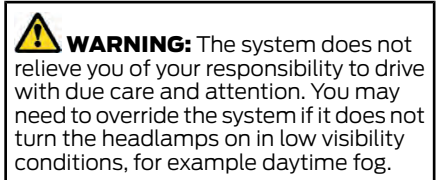

Autolamps turn the headlamps on in low light situations or when the windshield wipers operate.

AUTOLAMP SETTINGS

1. Using the instrument cluster display controls on the steering wheel, select **Settings**.
2. Select **Vehicle Settings**.
3. Select **Lighting**.
4. Select **Autolamp Delay**.
5. Select a setting and press the **OK** button.

Exterior Lighting

EXTERIOR LAMPS

USING THE TURN SIGNAL LAMPS



Push the lever up or down to switch the turn signal lamps on.

Set the lever to the middle position to switch the turn signal lamps off.

Note: Tap the lever up or down to make the turn signal lamps flash three times.

Turn Signal Lamp Indicator



It flashes when you switch the turn signal lamps on.

Note: An increase in the rate of flashing warns of a failed turn signal lamp.

HOW DO CORNERING LAMPS WORK

The cornering lamps illuminate the inside of a corner when you are turning the steering wheel or when you switch the turn signal lamps on.

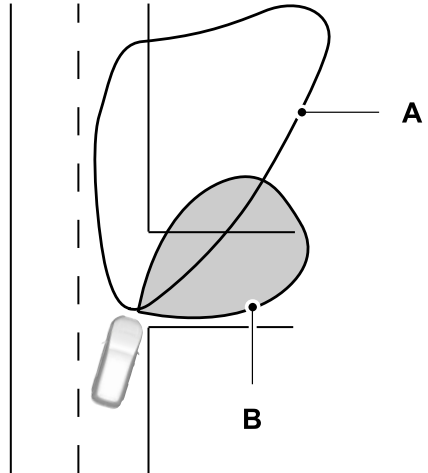

A Headlamp beam.

B Cornering lamp beam.

SWITCHING THE DAYTIME RUNNING LAMPS ON AND OFF - VEHICLES WITH: DAYTIME RUNNING LAMPS (DRL)



WARNING: The daytime running lamps system may not activate the rear lamps and may not provide adequate lighting during low visibility driving conditions. Make sure you switch the headlamps on, as appropriate, during all low visibility conditions. Failure to do so may result in a crash.

Daytime running lamps are always on unless you switch on the headlamps or your vehicle is in park (P).

Exterior Lighting

SWITCHING THE DAYTIME RUNNING LAMPS ON AND OFF - VEHICLES WITH: CONFIGURABLE DAYTIME RUNNING LAMPS



WARNING: The daytime running lamps system does not activate the rear lamps and may not provide adequate lighting during low visibility driving conditions. Make sure you switch the headlamps on, as appropriate, during all low visibility conditions. Failure to do so may result in a crash.

1. Using the instrument cluster display controls on the steering wheel, select **Settings**.
2. Select **Vehicle Settings**.
3. Select **Lighting**.
4. Switch **Daytime Running Lights** on or off.

The daytime running lamps turn on when all of the following occur:

- You switch the system on.
- You switch your vehicle on.
- The transmission is not in park (P).
- The lighting control is in the autolamps position.
- The headlamps are off.

Note: Other lighting control positions do not turn on the daytime running lamps.

USING THE FRONT FOG LAMPS

To switch the lamps on or off:

1. Set the lighting control to the parking lamps, headlamps or autolamps position.

Note: When the lighting control is in the autolamps position, you cannot switch the fog lamps on unless the low beam headlamps are on.

2.



Press the button on the lighting control to switch the front fog lamps on or off.

Note: Only switch the front fog lamps on during reduced visibility.

Note: The brightness of the daytime running lamps may decrease when the front fog lamps are switched on.

Note: The front fog lamps lights switch off automatically when high beams are activated.

Front Fog Lamps Indicator



It illuminates when you switch the front fog lamps on.

EXTERIOR LAMPS ON AUDIBLE WARNING

Sounds when you open the driver door and the exterior lamps are on.

AUTOMATIC HIGH BEAM CONTROL

HOW DOES AUTOMATIC HIGH BEAM CONTROL WORK

Automatic high beam control turns the high beams on if it is dark enough and no other traffic is present. If it detects an approaching vehicle's headlamps or tail lamps, or street lighting ahead, the system turns the high beams off.

A camera sensor, centrally mounted behind the windshield of your vehicle, continuously monitors conditions to turn the high beams on and off.

Exterior Lighting

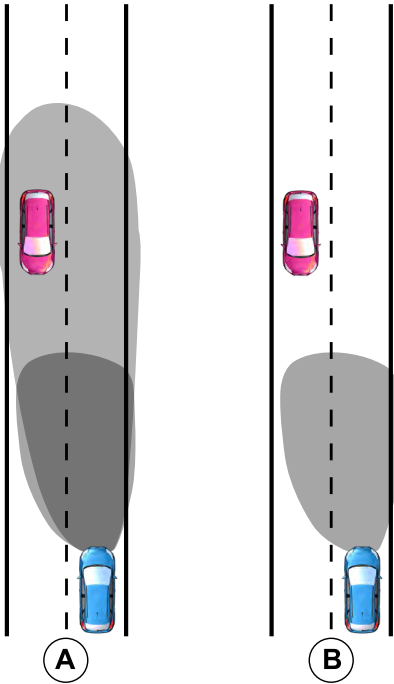

- A Without automatic high beam control.
- B With automatic high beam control.

AUTOMATIC HIGH BEAM CONTROL PRECAUTIONS

WARNING: The system does not relieve you of your responsibility to drive with due care and attention. You may need to override the system if it does not turn the high beams on or off.

- WARNING:** The system may not switch the high beams off if the lights of oncoming vehicles are hidden by obstacles, for example guard rails.
- WARNING:** You may need to override the system when approaching other road users.
- WARNING:** In situations with poor visibility, such as fog, heavy rain or other inclement weather, you may need to override or completely switch off the system.

AUTOMATIC HIGH BEAM CONTROL REQUIREMENTS

The system turns the high beams on if all of the following occur:

- You switch the system on.
- You set the lighting control to the autolamps position.
- The ambient light level is low enough that you require high beams.
- There is no traffic in front of your vehicle.
- The vehicle speed is greater than approximately 25 mph (40 km/h).

AUTOMATIC HIGH BEAM CONTROL LIMITATIONS

The system turns the high beams off if any of the following occur:

- You switch the system off.
- You set the lighting control to any position except autolamps.
- You switch the rear fog lamps on.
- The ambient light level is high enough that you do not require high beams.

Exterior Lighting

- The system detects an approaching vehicle's headlamps or a leading vehicle's tail lamps.
- The system detects severe rain, snow or fog.
- The system detects street lighting.
- The camera has reduced visibility.
- The vehicle speed falls below approximately 19 mph (30 km/h).

Note: *The deactivation speed may be lower on curves.*

SWITCHING AUTOMATIC HIGH BEAM CONTROL ON AND OFF

1. Using the instrument cluster display controls on the steering wheel, select **Settings**.
2. Select **Vehicle Settings**.
3. Select **Lighting**.
4. Switch **Auto Highbeam** on or off.

AUTOMATIC HIGH BEAM CONTROL INDICATORS



Illuminates white to confirm when the system is ready to assist. Illuminates blue when the high beam is activated.

OVERRIDING AUTOMATIC HIGH BEAM CONTROL



Push the lever away from you to switch between high beam and low beam.

AUTOMATIC HIGH BEAM CONTROL – TROUBLESHOOTING

AUTOMATIC HIGH BEAM CONTROL – INFORMATION MESSAGES

Message	Details
Front Camera Low Visibility Clean Screen	The camera has reduced visibility. Clean the windshield. If the message continues to appear, have your vehicle checked as soon as possible.
Front Camera Temporarily Not Available	The camera has malfunctioned. Wait a short period of time for the camera to cool down. If the message continues to appear, have your vehicle checked as soon as possible.
Front Camera Malfunction Service Required	The camera has malfunctioned. Have your vehicle checked as soon as possible.

Interior Lighting

SWITCHING ALL OF THE INTERIOR LAMPS ON AND OFF



INTERIOR LAMP FUNCTION

WHAT IS THE INTERIOR LAMP FUNCTION

The interior lamp function switches the courtesy and door lamps on or off.

SWITCHING THE INTERIOR LAMP FUNCTION ON AND OFF - BUS/VAN



When you set the switch to the middle position, the interior lamps turn on if:

- You open any door.
- You press the unlock button on the remote control.
- You switch the ignition off.

Note: If you switch the ignition off, the interior lamps could turn off after a short time to prevent the vehicle battery from running out of charge.

ADJUSTING THE INSTRUMENT PANEL LIGHTING BRIGHTNESS

The instrument lighting dimmer buttons are on the lighting control.



Repeatedly press one of the buttons to adjust the brightness.



Interior Lighting

CARGO LAMPS - VAN

SWITCHING THE CARGO LAMPS ON AND OFF



Press the button to switch the cargo lamps on. Press the button again to switch the cargo lamps off.

The cargo lamps turn off after a short period of time to prevent the battery from running out of charge.

Windows

OPENING AND CLOSING THE WINDOWS



WARNING: Do not leave children or pets unattended in your vehicle and do not let children play with the power windows. Failure to follow this instruction could result in personal injury or death.



WARNING: When closing the power windows, verify that they are free of obstructions and make sure children and pets are not in the proximity of the window openings. Failure to follow this instruction could result in personal injury or death.



WARNING: If an obstruction is detected, release the switch and reverse the window immediately. Failure to follow this instruction could result in personal injury or death.



WARNING: Do not leave a key or remote control unattended in the vehicle. Children or pets could operate the power windows and could become trapped in a closing window. Failure to follow this instruction could result in personal injury or death.



Press the window control switch to open the window. Lift the window control switch to close the window.

Note: *The power windows operate with the ignition on, and for several minutes after you switch the ignition off or until you open a front door.*

To reduce wind noise or pulsing noise when one window is open, slightly open the opposite window.

Driver Side One-Touch Open

Fully press the window control switch and release it. Press again or lift it to stop the window.

Driver Side One-Touch Close

Fully lift the window control switch and release it. Press again or lift it to stop the window.

Resetting Driver Side One-Touch Close

1. Lift and hold the window control switch until the window is fully closed.
2. Release the window control switch.
3. Lift the window control switch for one more second.
4. Release the window control switch.
5. Lift the window control switch again for one more second.

Note: *Repeat the procedure if the window does not close when you use one-touch.*

WINDOW BOUNCE-BACK

WHAT IS WINDOW BOUNCE-BACK

The window stops and reverses if it detects an obstruction when closing.

OVERRIDING WINDOW BOUNCE-BACK



WARNING: If you override bounce-back, the window does not reverse if it detects an obstacle. Take care when closing the windows to avoid personal injury or damage to your vehicle.

1. Close the window twice until it reaches the point of resistance and let it reverse.

Windows

2. Close the window a third time to the point of resistance. Bounce-back is now disabled and you can close the window manually.

Note: *The window goes past the point of resistance and you can fully close it.*

Note: *If the window does not close, have your vehicle checked as soon as possible.*

RESETTING WINDOW BOUNCE-BACK



WARNING: Bounce-back is off until you reset the memory. Take care when closing the windows to avoid personal injury or damage to your vehicle.

1. Lift and hold the window control switch until the window is fully closed.
2. Release the switch.
3. Lift the switch again for one more second.
4. Release the switch.
5. Lift the switch again for one more second.

Note: *Repeat the procedure if the window does not close when you use one-touch.*

Note: *If you have disconnected the battery, you must reset the bounce-back memory.*

Interior Mirror

INTERIOR MIRROR PRECAUTIONS



WARNING: Do not adjust the mirrors when your vehicle is moving. This could result in the loss of control of your vehicle, serious personal injury or death.

Note: Do not clean the mirror housing or glass with harsh abrasives, fuel or other petroleum-based cleaning products.

MANUALLY DIMMING THE INTERIOR MIRROR

Pull the tab below the mirror toward you to reduce glare at night.

AUTO-DIMMING INTERIOR MIRROR

WHAT IS THE AUTO-DIMMING INTERIOR MIRROR

The mirror dims to reduce the effect of bright light from behind. It returns to normal when the bright light from behind is no longer present or if you shift into reverse (R).

AUTO-DIMMING INTERIOR MIRROR LIMITATIONS

Do not block the sensors on the front and back of the mirror.

Note: A rear center passenger or raised rear center head restraint could prevent light from reaching the sensor.

DIGITAL INTERIOR MIRROR

WHAT IS THE DIGITAL INTERIOR MIRROR

The digital interior mirror provides a normal rear view and a panoramic rear view in the mirror using a camera at the back of your vehicle.

DIGITAL INTERIOR MIRROR LIMITATIONS

The camera is above the rear door. Optimal system performance requires a clear view by the camera lens.

When your vehicle is in reverse the mirror does not display the panoramic rear view.

SWITCHING BETWEEN NORMAL VIEW AND CAMERA VIEW

Pull or push the tab below the mirror to change the view.

DIGITAL INTERIOR MIRROR SETTINGS

1. Start your vehicle.
2. Pull the tab below the mirror toward you.
3. Adjust the angle and the brightness of the mirror.

Note: You can adjust the brightness with the arrow buttons.

Note: Push and hold the menu button for a few seconds to adjust the angle with the arrow buttons.

Exterior Mirrors

ADJUSTING THE EXTERIOR MIRRORS



WARNING: Do not adjust the mirrors when your vehicle is moving. This could result in the loss of control of your vehicle, serious personal injury or death.

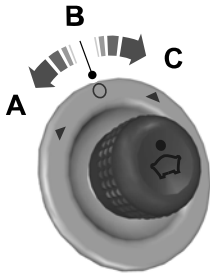

- A Left-hand mirror switch.
- B Neutral.
- C Right-hand mirror switch.

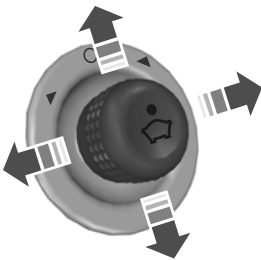

Move the adjustment control in the direction of the arrows to adjust the mirror.

FOLDING THE EXTERIOR MIRRORS - VEHICLES WITH: MANUAL FOLD EXTERIOR MIRRORS

Push the mirror toward the door window glass.

Make sure that you fully engage the mirror in its support when returning it to its original position.

FOLDING THE EXTERIOR MIRRORS - VEHICLES WITH: POWER FOLD EXTERIOR MIRRORS

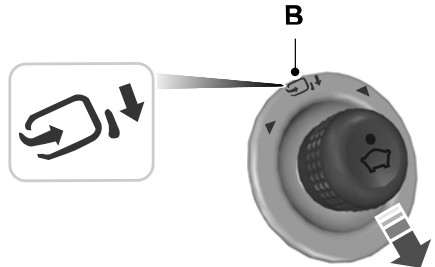

Move the adjustment control downward to fold or unfold the mirrors.

Note: The power folding mirrors operate with the ignition on, and for several minutes after you switch the ignition off.

Note: You can only fold the mirrors when the adjustment control is set to position B.

Note: If you fold and unfold the mirrors several times within one minute, the power fold function could turn off to protect the motors from overheating.

Note: Do not manually fold or unfold power folding mirrors.

Exterior Mirrors

Loose Mirror

If your power-folding mirrors are manually folded, they may not work properly, even after you re-position them. You need to reset them if:

- The mirrors vibrate when you drive.
- The mirrors feel loose.
- The mirrors do not stay in the folded or unfolded position.
- One of the mirrors is not in its normal driving position.

To reset the power-fold feature, use the power-folding mirror control to fold and unfold the mirrors. You may hear a loud noise as you reset the power-folding mirrors. This sound is normal. Repeat this process as needed each time the mirrors are manually folded.

Instrument Cluster

INSTRUMENT CLUSTER OVERVIEW - GASOLINE

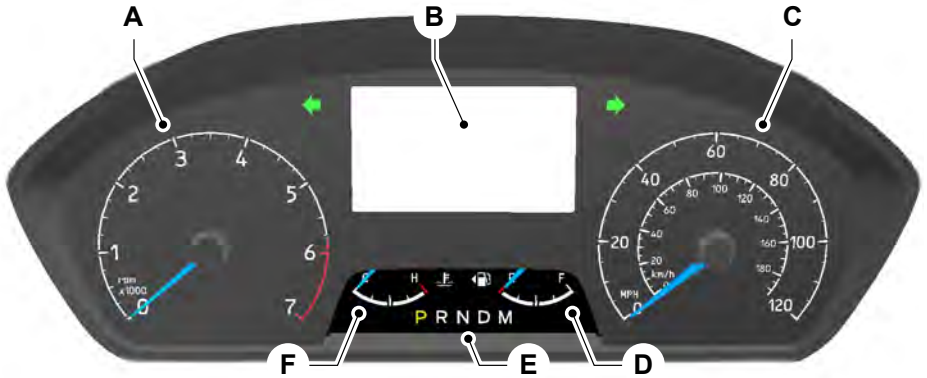

- A Tachometer.
- B Instrument cluster display.
- C Speedometer.
- D Fuel gauge.
- E Automatic transmission position indicators.
- F Engine coolant temperature gauge.

Instrument Cluster

INSTRUMENT CLUSTER OVERVIEW - BATTERY ELECTRIC VEHICLE

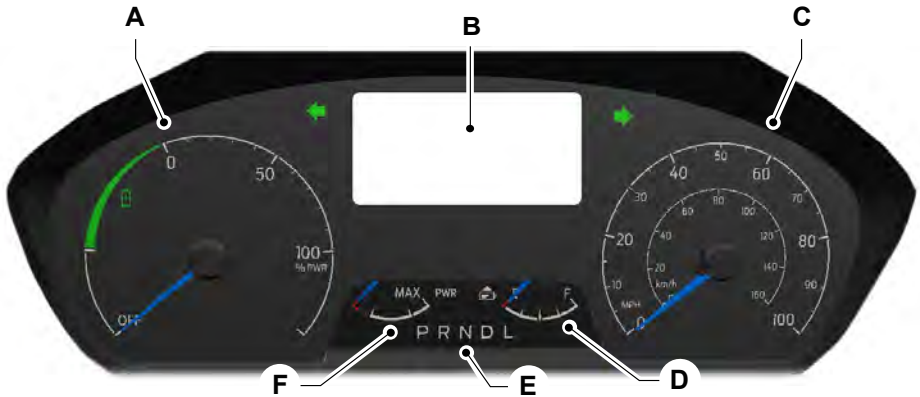

- A Power gauge.
- B Instrument cluster display.
- C Speedometer.
- D High voltage battery gauge.
- E Automatic transmission position indicators.
- F Power availability.

TACHOMETER - GASOLINE

Indicates the engine speed.

POWER GAUGE - BATTERY ELECTRIC VEHICLE

The Power Gauge displays power to the wheels when accelerating or maintaining speed. When slowing down by lifting your foot off the accelerator pedal or pressing the brake, the gauge displays the power captured by the regenerative braking system and returned to the high voltage battery.

Instrument Cluster

What is Power Availability Gauge

Displays total available vehicle power. Available power may be limited due to temperature or low battery state of charge. See **Maximizing Your Driving Range** (page 333).

SPEEDOMETER

Indicates the vehicle speed.

FUEL GAUGE - GASOLINE

WHAT IS THE FUEL GAUGE

Indicates approximately how much fuel is in the fuel tank.

FUEL GAUGE LIMITATIONS

The fuel gauge may not provide an accurate reading when your vehicle is on an incline.

LOCATING THE FUEL FILLER DOOR

The arrow adjacent to the fuel pump symbol indicates on which side of your vehicle the fuel filler door is located.

WHAT IS THE LOW FUEL REMINDER

A low fuel level reminder displays and sounds when the distance to empty reaches 75 mi (120 km) to empty for MyKey, and at 50 mi (80 km), 25 mi (40 km), 12 mi (20 km) and 0 mi (0 km) for all vehicle keys.

Note: *The low fuel reminder can appear at different fuel gauge positions depending on fuel economy conditions. This variation is normal.*

WHAT IS DISTANCE TO EMPTY

Indicates the approximate distance your vehicle can travel on the fuel remaining in the tank.

VEHICLE RANGE DISPLAY - BATTERY ELECTRIC VEHICLE



Displays the approximate range your vehicle can travel on the battery's current state of charge. Estimates vary based on the energy used when driving and the energy available in the high voltage battery.

The amount of energy being used when driving is affected by:

- Mild or aggressive acceleration or braking.
- Your vehicle's speed.
- Use of accessories, such as climate control.
- Ambient temperature and weather conditions.
- Driving in a city or on a highway.
- Driving on hilly road conditions.
- Driving while carrying a heavy load.
- Towing.

Instrument Cluster

The available energy capacity in the high voltage battery is affected by cold temperatures and battery degradation.

See **Preserving Your High Voltage Battery** (page 191).

Note: *It is normal for the vehicle range estimates to vary due to changes in average energy usage and battery temperature. This could cause different range estimates each time you fully charge your battery. See **Maximizing Your Driving Range** (page 333).*

Note: *When you leave your vehicle unplugged, it periodically uses energy from the high voltage battery to recharge the 12-volt accessory battery, resulting in a reduced driving range.*

HIGH VOLTAGE BATTERY GAUGE - BATTERY ELECTRIC VEHICLE

Displays the high voltage battery state of charge in the form of a gauge or a percentage. A full fill or 100% charge represents the total amount of energy you can get from plugging your vehicle in.

The indicator is normally white. When you reach a low battery condition, the indicator illuminates amber.

ENGINE COOLANT TEMPERATURE GAUGE - GASOLINE

Indicates the engine coolant temperature.

WHAT ARE THE INSTRUMENT CLUSTER WARNING LAMPS

Warning lamps alert you to a vehicle condition that could become serious. Some lamps illuminate when you start your vehicle to make sure they work. If any lamps remain on after starting your vehicle, refer to the respective system warning lamp for further information.

INSTRUMENT CLUSTER WARNING LAMPS

Airbag Warning Lamp



If it does not illuminate when you switch the ignition on, continues to flash or remains on when the engine is running, this indicates a malfunction. Have your vehicle checked as soon as possible.

Anti-Lock Brake System Warning Lamp



If it illuminates when you are driving, this indicates a malfunction. Your vehicle continues to have normal braking without the anti-lock brake system function. Have your vehicle checked as soon as possible.

Blind Spot Information System And Cross Traffic Alert Warning Lamp



It could illuminate if the system is switched off. If the system malfunctions, the warning lamp illuminates in the instrument cluster and a message appears in the information display. Have your vehicle checked as soon as possible.

Instrument Cluster

Brake Pad Wear Warning Lamp



It illuminates when the brake pads have worn down to a predetermined limit. Have your vehicle checked as soon as possible.

Door Ajar Warning Lamp



It illuminates when you switch the ignition on and remains on if any door or the hood is open.

Electric Park Brake Warning Lamp



It illuminates or flashes yellow when the electric parking brake requires service.



Engine Coolant Temperature Warning Lamp



If it illuminates when your vehicle is moving, this indicates that the engine is overheating. Stop your vehicle as soon as it is safe to do so and switch the engine off. Have your vehicle checked as soon as possible.

Engine Oil Pressure Warning Lamp



It illuminates when you switch the ignition on. If it illuminates when the engine is running this indicates a malfunction. Stop your vehicle as soon as it is safe to do so and switch the engine off. Check the engine oil level. If the oil level is sufficient, this indicates a system malfunction. Have your vehicle checked as soon as possible.

Engine Warning Lamp



If both lamps illuminate when the engine is running, stop your vehicle as soon as it is safe to do so. Continuing to drive your vehicle may cause reduced power or the engine to stop.



Switch the ignition off and attempt to restart the engine. Have your vehicle checked as soon as possible.

Fasten Seatbelt Warning Lamp



It illuminates until you fasten your seatbelt.

High Voltage Battery



It illuminates white under normal conditions. If it illuminates amber, then the battery is low on charge.

Ignition Warning Lamp



It illuminates when you switch the ignition on. If it illuminates when the engine is running this indicates a malfunction. Have your vehicle checked as soon as possible.

Lane Keeping System Warning Lamp



It could illuminate when you switch the system off. If it illuminates when you are driving, this indicates a malfunction. Have your vehicle checked as soon as possible.

Instrument Cluster

Limited Performance Warning Lamp



If it illuminates if your vehicle has limited performance due to a cold or hot battery. Drive with caution. Keep your vehicle connected to a charging system when not in use to maintain battery temperature.

Low Beam Warning Lamp



Illuminates when the low beam headlamp bulb is not functioning properly.

Low Fuel Level Warning Lamp



If it illuminates when you are driving, refuel as soon as possible.

Malfunction Indicator Lamp



If it illuminates when the engine is running this indicates a malfunction. If it flashes, engine misfire may be occurring. Increased exhaust gas temperatures could damage the diesel particulate filter or other vehicle components. Avoid heavy acceleration and deceleration and have your vehicle checked as soon as possible.

Parking Brake Warning Lamp



If it illuminates when you engage the parking brake and the ignition is on. If it illuminates



when your vehicle is moving, make sure the parking brake is disengaged. If the parking brake is disengaged, this indicates low brake fluid level or a brake system fault. Have your vehicle checked as soon as possible.

Powertrain Warning Lamp



If it illuminates when the engine is running this indicates a malfunction. If it flashes when you are driving, immediately reduce the vehicle speed. Avoid heavy acceleration and deceleration and have your vehicle checked as soon as possible.

Pre-Collision Assist Warning Lamp



If it illuminates if your vehicle rapidly approaches another vehicle, to warn you of the risk of a crash with the vehicle in front of you. It could illuminate red if the distance to the vehicle ahead is small. It illuminates amber when you switch the system off or if the system is not available.

Stability Control and Traction Control Indicator



Flashes during operation.

If it does not illuminate when you switch the ignition on, or remains on when the engine is running, this indicates a malfunction. Have your vehicle checked as soon as possible.

Note: *The system is designed to turn off if it detects a malfunction.*

Stability Control And Traction Control Off Warning Lamp



If it illuminates when you switch the system off.

Stop Safely Warning Lamp



If it illuminates if an electrical component requires service or a failure that causes your vehicle to shutdown or enter into a limited operating mode.

Instrument Cluster

Tire Pressure Monitoring System Warning Lamp



It illuminates if the tire pressure in one or more tires is below the correct tire pressure. If it does not illuminate when you switch the ignition on, or flashes when the engine is running, this indicates a malfunction. Have your vehicle checked as soon as possible.

WHAT ARE THE INSTRUMENT CLUSTER INDICATORS

Indicators notify you of various features that are active on your vehicle.

INSTRUMENT CLUSTER INDICATORS

Adaptive Cruise Control Indicator



It illuminates when you switch the system on. It illuminates white when the system is in standby mode. It illuminates green when you set the adaptive cruise speed.

Auto-Start-Stop Indicators



It illuminates green when the engine stops. It flashes amber and a message appears when you need to take action. It illuminates gray with a strikethrough when the system is not available.



Automatic High Beam Control On Indicator



It illuminates to confirm when the system is ready to assist.

Blind Spot Information System Indicator



When the system detects a vehicle, the indicator illuminates in the exterior mirror on the side the approaching vehicle is coming from. If you turn the direction indicator on for that side of your vehicle, the indicator flashes.

Cross Traffic Alert Indicator



When the system detects an approaching vehicle, a tone sounds, the indicator illuminates and arrows appear in the information display to show which side the approaching vehicle is coming from.



When the system detects an approaching vehicle, the indicator illuminates in the exterior mirror on the side the approaching vehicle is coming from.

Cruise Control Indicator



It illuminates when you switch the system on.

Direction Indicator



Direction indicator. It flashes when you switch the direction indicators on.

Eco Mode Indicator



It illuminates when the drive mode is selected.

Front Fog Lamp Indicator



It illuminates when you switch the front fog lamps on.

Instrument Cluster

Hazard Flasher Indicator



It flashes when you switch the hazard flashers on.

High Beam Headlamp Indicator



It illuminates when you switch the high beam headlamps on.

Lamps On Indicator



It illuminates when you switch the low beam headlamps or the side and rear lamps on.

Lane Keeping Aid Indicator



It illuminates in the information display when you switch the system on and Aid Mode or Alert and Aid Mode are selected.

Lane Keeping Alert Indicator



It illuminates in the information display when you switch the system on and Alert Mode is selected.

Mud/Ruts Mode Indicator



It illuminates when the drive mode is selected.

Ready to Drive Indicator



It illuminates when you have switched on your vehicle and it is ready to drive. A corresponding message may appear stating ready to drive.

Slippery Mode Indicator



It illuminates when the drive mode is selected.

Stability Control And Traction Control Indicator



It flashes during operation. If it does not illuminate when you switch the ignition on, or remains on when the engine is running, this indicates a malfunction. Have your vehicle checked as soon as possible.

Tow/Haul Mode Indicator



It illuminates when the drive mode is selected.

Vehicle Plugged In Indicator



It illuminates when your vehicle is plugged in.

Instrument Cluster Display - Gasoline

USING THE INSTRUMENT CLUSTER DISPLAY CONTROLS



E257718

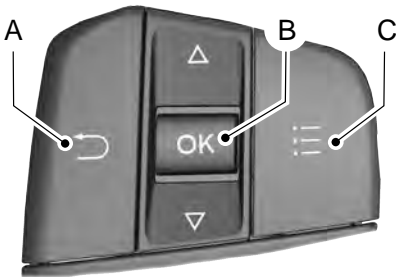

- A Return button.
- B OK button.
- C Menu button.

Return Button

Use the return button to go back or to exit.

OK Button

Use the **OK** button to make a selection. You can also use it to scroll through a menu.

Menu button

Use the menu button on the main screen to display the submenu.

INSTRUMENT CLUSTER DISPLAY MAIN MENU

Menu Item
Trip 1 or Trip 2
MyView
Driver Assist.
Navigation
Audio
Phone
Settings

CUSTOMIZING THE INSTRUMENT CLUSTER DISPLAY

1. Using the instrument cluster display controls on the steering wheel, select **MyView**.
2. Select a screen.
3. Press the **OK** button.

PERSONALIZED SETTINGS

CHANGING THE INSTRUMENT CLUSTER DISPLAY LANGUAGE

1. Using the instrument cluster display controls on the steering wheel, select **Settings**.
2. Select **Display**.
3. Select **Language**.

Instrument Cluster Display - Gasoline

4. Select a setting and press the **OK** button.

CHANGING THE MEASUREMENT UNIT

1. Using the instrument cluster display controls on the steering wheel, select **Settings**.
2. Select **Display**.
3. Select **Measurement Unit**.
4. Select a setting and press the **OK** button.

CHANGING THE TEMPERATURE UNIT

1. Using the instrument cluster display controls on the steering wheel, select **Settings**.
2. Select **Display**.
3. Select **Temperature Unit**.
4. Select a setting and press the **OK** button.

CHANGING THE TIRE PRESSURE UNIT

1. Using the instrument cluster display controls on the steering wheel, select **Settings**.
2. Select **Display**.
3. Select **Tire Pressure**.
4. Select a setting and press the **OK** button.

SWITCHING THE INSTRUMENT CLUSTER DISPLAY AUDIBLE WARNINGS ON AND OFF

1. Using the instrument cluster display controls on the steering wheel, select **Settings**.

2. Select **Vehicle**.
3. Select **Chimes**.
4. Select a setting and press the **OK** button.

FUEL ECONOMY DISPLAY

An instant fuel economy gauge is provided along with average fuel economy. Average fuel economy is continuously averaged since the last reset.

Note: Press and hold the **OK** button on the controls on the steering wheel to reset your average fuel economy.

Instrument Cluster Display - Battery Electric Vehicle

USING THE INSTRUMENT CLUSTER DISPLAY CONTROLS

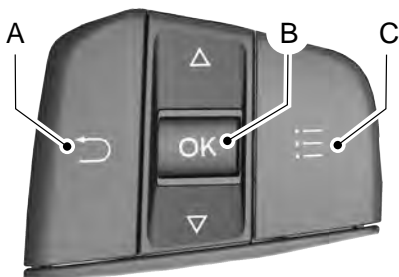

- A Return button.
- B OK button.
- C Menu button.

Return Button

Use the return button to go back or to exit.

OK Button

Use the **OK** button to make a selection. You can also use it to scroll through a menu.

Menu button

Use the menu button on the main screen to display the submenu.

INSTRUMENT CLUSTER DISPLAY MAIN MENU

Menu Item
Trip 1 or Trip 2
MyView
Driver Assist.
Navigation
Audio
Phone
Settings

CUSTOMIZING THE INSTRUMENT CLUSTER DISPLAY

- Using the instrument cluster display controls on the steering wheel, select **MyView**.
- Select a screen.
- Press the **OK** button.

PERSONALIZED SETTINGS

CHANGING THE INSTRUMENT CLUSTER DISPLAY LANGUAGE

- Using the instrument cluster display controls on the steering wheel, select **Settings**.
- Select **Display**.
- Select **Language**.

Instrument Cluster Display - Battery Electric Vehicle

4. Select a setting and press the **OK** button.

CHANGING THE MEASUREMENT UNIT

1. Using the instrument cluster display controls on the steering wheel, select **Settings**.
2. Select **Display**.
3. Select **Measurement Unit**.
4. Select a setting and press the **OK** button.

CHANGING THE TEMPERATURE UNIT

1. Using the instrument cluster display controls on the steering wheel, select **Settings**.
2. Select **Display**.
3. Select **Temperature Unit**.
4. Select a setting and press the **OK** button.

CHANGING THE TIRE PRESSURE UNIT

1. Using the instrument cluster display controls on the steering wheel, select **Settings**.
2. Select **Display**.
3. Select **Tire Pressure**.
4. Select a setting and press the **OK** button.

SWITCHING THE INSTRUMENT CLUSTER DISPLAY AUDIBLE WARNINGS ON AND OFF

1. Using the instrument cluster display controls on the steering wheel, select **Settings**.

2. Select **Vehicle**.
3. Select **Chimes**.
4. Select a setting and press the **OK** button.

TRIP SUMMARY

Displays the trip summary when you switch off your vehicle. The values are cumulative since you last started your vehicle.

VEHICLE CHARGING STATUS

The vehicle charge status displays when you switch off your vehicle and when you switch on your vehicle when plugged in. Charging status includes the charge start or charge end time as appropriate. When DC charging, the time at 80% displays followed by the time at 100%. You can modify your charge settings through the touchscreen.

Trip Computer

ACCESSING THE TRIP COMPUTER

1. Navigate to the trip screen.
2. Press the menu button.
3. Select **Trip 1** or **Trip 2**.

RESETTING THE TRIP COMPUTER

1. Navigate to the trip screen.
2. Press the menu button.
3. Select **Trip 1** or **Trip 2**.
4. Press and hold the **OK** button for a few seconds.

RESETTING THE INDIVIDUAL TRIP VALUES

1. Navigate to the trip screen.
2. Press the menu button.
3. Select **Trip 1** or **Trip 2**.
4. Select **Reset Individual Values**.
5. Select the value to reset.
6. Press and hold the **OK** button for a few seconds.

CONFIGURING THE TRIP COMPUTER

1. Navigate to the trip screen.
2. Press the menu button.
3. Select **Trip 1** or **Trip 2**.
4. Select **Configure View**.
5. Select the value to display.
6. Press the **OK** button.

TRIP DATA

Trip data includes distance, time and energy economy. Better energy economy, meaning greater efficiency or lower consumption, results in increased driving range.

Remote Start

WHAT IS REMOTE START

The system allows you to remotely start your vehicle and therefore to heat or cool the interior to a predetermined temperature.

REMOTE START LIMITATIONS - GASOLINE

Remote start does not work if:

- The alarm horn is sounding.
- The hood is open.
- The transmission is not in park (P).
- Remote start is not enabled.
- The ignition is on.

Note: Do not use remote start if your fuel level is low.

REMOTE START LIMITATIONS - BATTERY ELECTRIC VEHICLE

Remote start does not work if:

- The alarm horn is sounding.
- The hood is open.
- The transmission is not in park (P).
- Remote start is not enabled.
- The vehicle is switched on.
- The vehicle battery is below the minimum operating voltage.

ENABLING REMOTE START

1. Press **Settings** on the touchscreen.
2. Press **Vehicle**.
3. Press **Remote Start Setup**.
4. Switch **Remote Start** on or off.

Note: To remote start with FordPass, make sure that the modem is enabled. See **Connecting FordPass to the Modem** (page 472).

REMOTELY STARTING AND STOPPING THE VEHICLE - GASOLINE



WARNING: Do not start the engine in a closed garage or in other enclosed areas. Exhaust fumes are toxic. Always open the garage door before you start the engine. Failure to follow this instruction could result in personal injury or death.

Use the FordPass App to start the vehicle.

Note: The turn signal lamps flash twice.

Note: The parking lamps turn on when the vehicle is running.

Note: The horn sounds if the system fails to start.

Note: All other vehicle systems remain off when you have remotely started the vehicle.

Note: You may have to wait a short period of time before remotely starting the vehicle after the vehicle stops running.

Note: The vehicle remains secured when you have remotely started it. A valid key must be inside your vehicle to switch the ignition on and drive your vehicle.

Note: A maximum of two remote starts are allowed. After that you need to turn the ignition on and off before you can use remote start again.

Use the FordPass App to switch the vehicle off.

Remote Start

REMOTELY STARTING AND STOPPING THE VEHICLE - BATTERY ELECTRIC VEHICLE

Use the FordPass App to start the vehicle.

Note: The turn signal lamps flash twice.

Note: The parking lamps turn on when the vehicle is running.

Note: The horn sounds if the system fails to start.

Note: All other vehicle systems remain off when you have remotely started the vehicle.

Note: You may have to wait a short period of time before remotely starting the vehicle after the vehicle stops running.

Note: The vehicle remains secured when you have remotely started it. A valid key must be inside your vehicle to switch the vehicle on and drive your vehicle.

Note: A maximum of two remote starts, or one remote start with an extension are allowed. To reset the restart procedure switch the vehicle on, then off.

Note: If your vehicle is plugged in during remote start it uses energy from your charging source.

Use the FordPass App to switch the vehicle off.

EXTENDING THE REMOTE START DURATION

Use your FordPass App to extend the remote start duration.

If the duration is set to 15 minutes, the duration extends by another 15 minutes. This provides a total of 30 minutes.

Note: Remote start can only be extended once.

REMOTE START SETTINGS

Climate Control Settings

1. Press **Settings** on the touchscreen.
2. Press **Vehicle**.
3. Press **Remote Start Setup**.
4. Press **Climate Control**.
5. Press a setting.

Note: If you select **Auto**, the system attempts to heat or cool the interior to 72°F (22°C).

Note: If you select **Last Settings**, the system remembers the last used settings.

Note: You cannot adjust the climate control settings when you have remotely started the vehicle.

Note: When you switch the ignition on, the climate control system returns to the last used settings.

Heated Seat Settings

1. Press **Settings** on the touchscreen.
2. Press **Vehicle**.
3. Press **Remote Start Setup**.
4. Press **Seats**.
5. Press a setting.

Note: If you switch the heated seat settings to **Auto**, the heated seats turn on during cold weather.

Note: You cannot adjust the heated seat settings when you have remotely started the vehicle.

Setting the Remote Start Duration

You can set a duration for Remote Start to run.

1. Press **Settings** on the touchscreen.
2. Press **Vehicle**.
3. Press **Remote Start Setup**.

Remote Start

4. Press ***Duration***.
5. Press a setting.

Climate Control - Vehicles With: Automatic Temperature Control

SWITCHING CLIMATE CONTROL ON AND OFF



Press the button to activate the selection screen.



Press the button.

SWITCHING RECIRCULATED AIR ON AND OFF



Press the button to activate the selection screen.



Press the button to recirculate air currently in the passenger compartment.

Note: *Recirculated air may turn off automatically, or prevent you from switching on in all air flow modes except MAX A/C to reduce the risk of fogging. Recirculation may also turn on and off automatically in various air distribution control combinations to improve heating or cooling efficiency.*

SWITCHING AIR CONDITIONING ON AND OFF



Press the button.

Note: *Under certain conditions, the air conditioning compressor could continue to operate after you switch air conditioning off.*

Note: *To keep the system and its components fully functional, switch air conditioning on and let your vehicle idle at least once per month for a minimum of two minutes.*

SWITCHING DEFROST ON AND OFF



Press the button to activate the selection screen.



Press the button on the touchscreen to switch the windshield air vents on.



Make sure that the instrument panel air vents are switched off.



Make sure that the footwell air vents are switched off.

SWITCHING MAXIMUM DEFROST ON AND OFF



Press the button on the touchscreen.

Air flows through the windshield air vents, and the blower motor adjusts to the highest speed.

You can also use this setting to defog and clear the windshield of a thin covering of ice.

Note: *You can also press the button on the instrument panel to switch the maximum defrost on or off.*

Note: *To prevent window fogging, you cannot select recirculated air when maximum defrost is on.*

Note: *The heated rear window and air conditioning also turn on when you select maximum defrost.*

Climate Control - Vehicles With: Automatic Temperature Control

SWITCHING MAXIMUM COOLING ON AND OFF



Press the button to activate the selection screen.



Press the button.

Note: When you switch maximum cooling off, air conditioning remains on.

Note: In certain conditions, for example, cold weather, maximum cooling may not activate or could run slow when switched on. This helps reduce power consumption from the battery.

SWITCHING THE ELECTRIC HEATER ON AND OFF - BATTERY ELECTRIC VEHICLE



Press the button to activate the selection screen.



Press the button to switch the electric heater on or off.

Note: The default setting is on.

Note: Disabling the system helps maximize your driving range.

Note: The system does not work in some climate control modes.

Note: This button does not switch off the climate control system.

Note: In certain conditions, for example warm weather, the system could not activate or could run with reduced performance when switched on.

SWITCHING THE HEATED REAR WINDOW ON AND OFF



Press the button to clear the rear window of thin ice and fog. The heated rear window turns off after a short period of time.

Note: Do not use harsh chemicals, razor blades or other sharp objects to clean or remove decals from the inside of the heated rear window as this could cause damage to the heated rear window grid lines not covered by the vehicle Warranty.

Note: The engine must be running or your vehicle must be ready to drive to switch the system on.

SETTING THE BLOWER MOTOR SPEED



Press the button to set the blower motor speed.



Slide the control to set the blower motor speed.

Note: You can press + or - to set the blower motor speed.

SWITCHING THE HEATED MIRRORS ON AND OFF - VEHICLES WITHOUT: HEATED REAR WINDOW



Press the button to clear the heated mirror of thin ice and fog. The system turns off after a short period of time.

Note: Do not remove ice from the mirrors with a scraper or adjust the mirror glass when it is frozen in place.

Climate Control - Vehicles With: Automatic Temperature Control

Note: Do not clean the mirror housing or glass with harsh abrasives, fuel or other petroleum-based cleaning products. The vehicle warranty may not cover damage caused to the mirror housing or glass.

Note: The engine must be running or your vehicle must be ready to drive to switch the system on.

SWITCHING THE HEATED MIRRORS ON AND OFF - VEHICLES WITH: HEATED REAR WINDOW

When you switch the heated rear window on, the heated exterior mirrors turn on. See **Switching the Heated Rear Window On and Off** (page 134).

Note: Do not remove ice from the mirrors with a scraper or adjust the mirror glass when it is frozen in place.

Note: Do not clean the mirror housing or glass with harsh abrasives, fuel or other petroleum-based cleaning products. The vehicle warranty may not cover damage caused to the mirror housing or glass.

Note: The engine must be running or your vehicle must be ready to drive to switch the system on.

SETTING THE TEMPERATURE

Press the temperature control to access the temperature settings.

 Slide the control to set the temperature.

Note: You can press + or - to set the temperature.

DIRECTING THE FLOW OF AIR

Directing Air to the Windshield Air Vents



Press the button to activate the selection screen.



Press the button on the touchscreen.

Directing Air to the Instrument Panel Air Vents



Press the button to activate the selection screen.



Press the button on the touchscreen.

Directing Air to the Footwell Air Vents



Press the button to activate the selection screen.



Press the button on the touchscreen.

AUTO MODE

SWITCHING AUTO MODE ON AND OFF



Press the button to switch auto mode on. Repeatedly press the button to adjust auto mode.

Adjust the blower motor control or air distribution control to switch auto mode off.

Climate Control - Vehicles With: Automatic Temperature Control

AUTO MODE INDICATORS

The indicators are on the Auto Mode button.

Auto Mode Indicator Status	Description
One indicator illuminated.	The blower motor speed is reduced. Use this setting to minimize the amount of noise from the blower motor. This setting increases the time taken to cool the interior.
Two indicators illuminated.	The blower motor speed is moderate.
Three indicators illuminated.	The blower motor speed is increased. Use this setting to reduce the time taken to cool the interior. This setting increases the amount of noise from the blower motor.

CLIMATE CONTROL HINTS - GASOLINE

General Hints

- Prolonged use of recirculated air may cause the windows to fog up.
- You may feel a small amount of air from the footwell air vents regardless of the air distribution setting.
- To reduce humidity build-up inside your vehicle, do not drive with the system switched off or with recirculated air always switched on.
- Do not place objects under the front seats as this may interfere with the airflow to the rear seats.
- Remove any snow, ice or leaves from the air intake area at the base of the windshield.
- To improve the time to reach a comfortable temperature in hot weather, drive with the windows open until you feel cold air through the air vents.

Automatic Climate Control

- Adjusting the settings when your vehicle interior is extremely hot or cold is not necessary. Automatic mode is best recommended to maintain set temperature.
- The system adjusts to heat or cool the interior to the temperature you select as quickly as possible.
- For the system to function efficiently, the instrument panel and side air vents should be fully open.
- If you press **AUTO** during cold outside temperatures, the system directs air flow to the windshield and side window air vents. In addition, the blower motor may run at a slower speed until the engine warms up.
- If you press **AUTO** during hot temperatures and the inside of the vehicle is hot, the system uses recirculated air to maximize interior cooling. Blower motor speed may also reduce until the air cools.

Quickly Heating the Interior

1. Press **AUTO**.

Climate Control - Vehicles With: Automatic Temperature Control

2. Adjust the temperature function to the setting you prefer.

Recommended Settings for Heating

1. Press **AUTO**.
2. Adjust the temperature function to the setting you prefer. Use 72°F (22°C) as a starting point, then adjust the setting as necessary.

Quickly Cooling the Interior

1. Press **MAX A/C**.
2. Drive with the windows open for a short period of time.

Recommended Settings for Cooling

1. Press **AUTO**.
2. Adjust the temperature function to the setting you prefer. Use 72°F (22°C) as a starting point, then adjust the setting as necessary.

Defogging the Side Windows in Cold Weather

1. Press and release defrost or maximum defrost.
2. Adjust the temperature control to the setting you prefer. Use 72°F (22°C) as a starting point, then adjust the setting as necessary.

CLIMATE CONTROL HINTS - BATTERY ELECTRIC VEHICLE

General Hints

- Use of the climate system will reduce your vehicles driving range. Conserve battery charge by using climate control features when necessary.
- Prolonged use of recirculated air may cause the windows to fog up.
- You may feel a small amount of air from the footwell air vents regardless of the air distribution setting.
- To reduce humidity build-up inside your vehicle, do not drive with the system switched off or with recirculated air always switched on.
- Remove any snow, ice or leaves from the air intake area at the base of the windshield.
- To improve the time to reach a comfortable temperature in hot weather, drive with the windows open until you feel cold air through the air vents.

Automatic Climate Control

- Adjusting the settings when your vehicle interior is extremely hot or cold is not necessary. Automatic mode is best recommended to maintain set temperature.
- The system adjusts to heat or cool the interior to the temperature you select as quickly as possible.
- For the system to function efficiently, the instrument panel and side air vents should be fully open.

Climate Control - Vehicles With: Automatic Temperature Control

- If you press **AUTO** during cold outside temperatures, the system directs air flow to the windshield and side window air vents. The blower motor speed may reduce until the air warms.
 - If you press **AUTO** during hot temperatures and the inside of the vehicle is hot, the system uses recirculated air to maximize interior cooling. Blower motor speed may also reduce until the air cools.
2. Adjust the temperature control to the setting you prefer. Use 72°F (22°C) as a starting point, then adjust the setting as necessary.

Quickly Heating the Interior

1. Press **AUTO**.
2. Adjust the temperature function to the setting you prefer.

Recommended Settings for Heating

1. Press **AUTO**.
2. Adjust the temperature function to the setting you prefer. Use 72°F (22°C) as a starting point, then adjust the setting as necessary.

Quickly Cooling the Interior

Press **MAX A/C**.

Recommended Settings for Cooling

1. Press **AUTO**.
2. Adjust the temperature function to the setting you prefer. Use 72°F (22°C) as a starting point, then adjust the setting as necessary.

Defogging the Side Windows in Cold Weather

1. Press and release defrost or maximum defrost.

Climate Control - Vehicles With: Manual Temperature Control

SWITCHING CLIMATE CONTROL ON AND OFF



Press the button.



Make sure that the instrument panel air vents are switched off.



Make sure that the footwell air vents are switched off.

SWITCHING RECIRCULATED AIR ON AND OFF



Press the button to recirculate air currently in the passenger compartment.

Note: Recirculated air may turn off automatically, or prevent you from switching on in all air flow modes except MAX A/C to reduce the risk of fogging. Recirculation may also turn on and off automatically in various air distribution control combinations to improve heating or cooling efficiency.

SWITCHING AIR CONDITIONING ON AND OFF



Press the button.

Note: Under certain conditions, the air conditioning compressor could continue to operate after you switch air conditioning off.

Note: To keep the system and its components fully functional, switch air conditioning on and let your vehicle idle at least once per month for a minimum of two minutes.

SWITCHING DEFROST ON AND OFF



Press the button to switch the windshield air vents on.

SWITCHING MAXIMUM DEFROST ON AND OFF



Turn the temperature control clockwise past the highest setting to maximize defrosting.

Note: The temperature control springs back to the highest setting.

Air flows through the windshield air vents, and the blower motor adjusts to the highest speed.

Note: To prevent window fogging, you cannot select recirculated air when maximum defrost is on.

Note: The heated rear window and air conditioning also turn on when you select maximum defrost.

SWITCHING MAXIMUM COOLING ON AND OFF



Turn the temperature control counterclockwise past the lowest setting to maximize cooling.

Note: The temperature control springs back to the lowest setting.

Note: When you switch maximum cooling off, air conditioning remains on.

Climate Control - Vehicles With: Manual Temperature Control

SWITCHING THE HEATED REAR WINDOW ON AND OFF



Press the button to clear the rear window of thin ice and fog. The heated rear window turns off after a short period of time.

Note: Do not use harsh chemicals, razor blades or other sharp objects to clean or remove decals from the inside of the heated rear window as this could cause damage to the heated rear window grid lines not covered by the vehicle Warranty.

SETTING THE BLOWER MOTOR SPEED



Note: Lights on the control illuminate to indicate the blower motor speed.

Note: When you switch the blower motor off, air conditioning turns off and the windows could fog up.

SWITCHING THE HEATED MIRRORS ON AND OFF - VEHICLES WITHOUT: HEATED REAR WINDOW



Press the button to clear the heated mirror of thin ice and fog. The system turns off after a short period of time.

Note: Do not remove ice from the mirrors with a scraper or adjust the mirror glass when it is frozen in place.

Note: Do not clean the mirror housing or glass with harsh abrasives, fuel or other petroleum-based cleaning products. The vehicle warranty may not cover damage caused to the mirror housing or glass.

Note: The engine must be running or your vehicle must be ready to drive to switch the system on.

SWITCHING THE HEATED MIRRORS ON AND OFF - VEHICLES WITH: HEATED REAR WINDOW

When you switch the heated rear window on, the heated exterior mirrors turn on. See **Switching the Heated Rear Window On and Off** (page 134).

Note: Do not remove ice from the mirrors with a scraper or adjust the mirror glass when it is frozen in place.

Note: Do not clean the mirror housing or glass with harsh abrasives, fuel or other petroleum-based cleaning products. The vehicle warranty may not cover damage caused to the mirror housing or glass.

Note: The engine must be running or your vehicle must be ready to drive to switch the system on.

SETTING THE TEMPERATURE

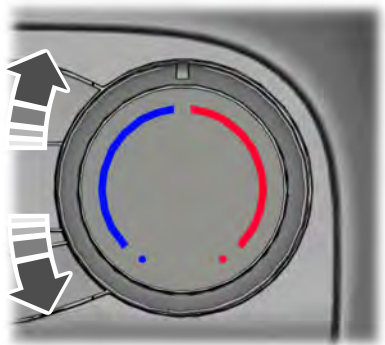

Climate Control - Vehicles With: Manual Temperature Control

Turn the temperature control counterclockwise for cooler temperature settings.

Turn the temperature control clockwise for warmer temperature settings.

DIRECTING THE FLOW OF AIR

Directing Air to the Windshield Air Vents



Press the button.

Directing Air to the Instrument Panel Air Vents



Press the button.

Directing Air to the Footwell Air Vents



Press the button.

CLIMATE CONTROL HINTS

General Hints

- Prolonged use of recirculated air may cause the windows to fog up.
- You may feel a small amount of air from the footwell air vents regardless of the air distribution setting.
- To reduce humidity build-up inside your vehicle, do not drive with the system switched off or with recirculated air always switched on.
- Do not place objects under the front seats as this may interfere with the airflow to the rear seats.

- Remove any snow, ice or leaves from the air intake area at the base of the windshield.
- To improve the time to reach a comfortable temperature in hot weather, drive with the windows open until you feel cold air through the air vents.

Quickly Heating the Interior

1. Adjust the blower motor speed to the highest speed setting.
2. Adjust the temperature control to the highest setting.
3. Direct air to the footwell air vents.

Recommended Settings for Heating

1. Adjust the blower motor speed to the center setting.
2. Adjust the temperature control to the midway point of the hot settings.
3. Direct air to the footwell air vents.

Quickly Cooling the Interior

1. Press **MAX A/C**.
2. Drive with the windows open for a short period of time.

Recommended Settings for Cooling

1. Adjust the blower motor speed to the center setting.
2. Adjust the temperature control to the midway point of the cold settings.
3. Direct air to the instrument panel air vents.

Defogging the Side Windows in Cold Weather

1. Direct air to the instrument panel and windshield air vents.

Climate Control - Vehicles With: Manual Temperature Control

2. Press and release **A/C**.
3. Adjust the temperature control to the setting you prefer.
4. Adjust the blower motor speed to the highest setting.
5. Direct air toward the side windows.
6. Close the instrument panel air vents.

Rear Passenger Climate Control

SETTING THE BLOWER MOTOR SPEED



DIRECTING THE FLOW OF AIR

Directing Air to the Overhead Air Vents



When you direct air to the overhead air vents, the system distributes cold air.

Directing Air to the Footwell Air Vents



When you direct air to the footwell air vents, the system distributes hot air.

Directing Air to the Overhead Air Vents and the Footwell Air Vents



When you direct air to the Overhead and footwell air vents, the system distributes warm air.

Front Seats

FRONT SEAT PRECAUTIONS



WARNING: Sitting improperly, out of position or with the seatback reclined too far can take weight off the seat cushion and affect the decision of the passenger sensing system, resulting in serious injury or death in the event of a crash. Always sit upright against your seat back, with your feet on the floor.



WARNING: Do not recline the seat backrest too far as this can cause the occupant to slide under the seatbelt, resulting in personal injury in the event of a crash.



WARNING: Do not place objects higher than the top of the seat backrest. Failure to follow this instruction could result in personal injury or death in the event of a sudden stop or crash.



WARNING: Do not adjust the driver seat or seat backrest when your vehicle is moving. This may result in sudden seat movement, causing the loss of control of your vehicle.

SITTING IN THE CORRECT POSITION

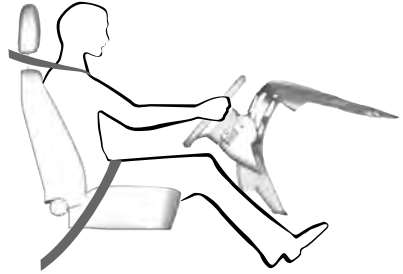

When you use them properly, the seat, head restraint, seatbelt and airbags will provide optimum protection in the event of a crash.

We recommend that you follow these guidelines:

- Sit in an upright position with the base of your spine as far back as possible.
- Do not recline the seat backrest so that your torso is more than 30 degrees from the upright position.
- Adjust the head restraint so that the top of it is level with the top of your head and as far forward as possible. Make sure that you remain comfortable.
- Keep sufficient distance between yourself and the steering wheel. We recommend a minimum of 10 in (25 cm) between your breastbone and the airbag cover.
- Hold the steering wheel with your arms slightly bent.

Front Seats

- Bend your legs slightly so that you can press the pedals fully.
- Position the shoulder strap of the seatbelt over the center of your shoulder and position the lap strap tightly across your hips.

Make sure that your driving position is comfortable and that you can maintain full control of your vehicle.

MANUAL SEATS

HEADRESTRAINT COMPONENTS

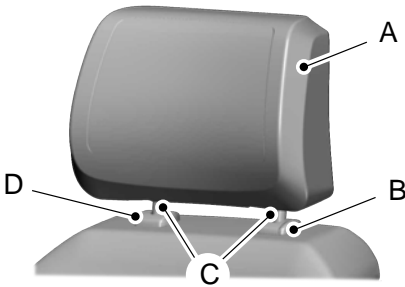

The head restraints consist of:

- A An energy absorbing head restraint.
- B Guide sleeve adjust and release button.
- C Two steel stems.
- D Guide sleeve unlock and remove button (If equipped).

ADJUSTING THE HEAD RESTRAINT

WARNING: Fully adjust the head restraint before you sit in or operate your vehicle. This will help minimize the risk of neck injury in the event of a crash. Do not adjust the head restraint when your vehicle is moving.

WARNING: The head restraint is a safety device. Whenever possible it should be installed and properly adjusted when the seat is occupied. Failure to adjust the head restraint properly could reduce its effectiveness during certain impacts.

WARNING: Adjust the head restraints for all passengers before you drive your vehicle. This will help minimize the risk of neck injury in the event of a crash. Do not adjust the head restraints when your vehicle is moving.

Adjust the head restraint so that the top of it is level with the top of your head.

Raising the Head Restraints

1. Pull the head restraint upward.
2. Make sure that the head restraint locks into place.

Lowering the Head Restraints

1. Press and hold the locking button.
2. Push the head restraint downward.
3. Make sure that the head restraint locks into place.

Front Seats

REMOVING THE HEAD RESTRAINT

 **WARNING:** Do not remove the head restraint from an occupied seat.

1. Recline the seat backrest so that there is enough room for you to remove the head restraint.

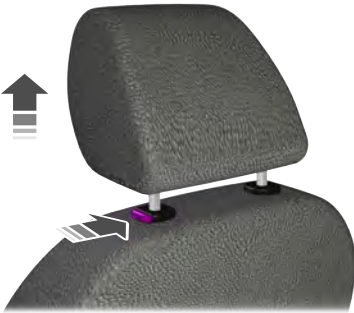



2. Press the locking button and remove the head restraint.

INSTALLING THE HEAD RESTRAINT

Align the steel stems into the guide sleeves and push the head restraint down until it locks.

MOVING THE SEAT BACKWARD AND FORWARD

 **WARNING:** Do not place cargo or any objects behind the seatback before returning it to the original position.

 **WARNING:** Make sure the seat fully locks into place by rocking it backward and forward. Not securing the seat into the locked position can be dangerous in a crash and could cause serious personal injury or death.



E177638

Note: The driver seat has removable stop bolts on the track to enable access to the vehicle battery. See **Changing the 12V Battery** (page 381). See **Changing the 12V Battery** (page 383).

Front Seats

ADJUSTING THE SEAT CUSHION - VEHICLES WITH: 4-WAY MANUAL SEAT

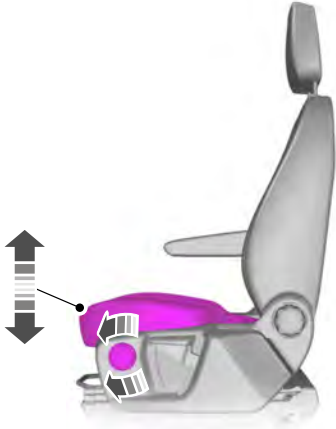

E146959

ADJUSTING THE SEAT HEIGHT - VEHICLES WITH: 4-WAY MANUAL SEAT

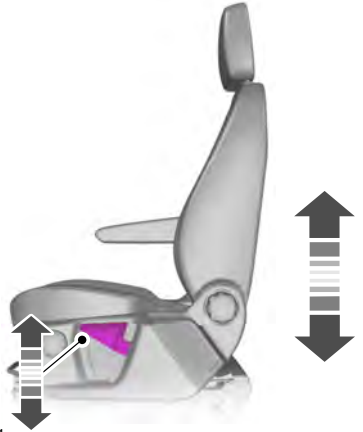

E146384

FOLDING THE SEAT ARMREST

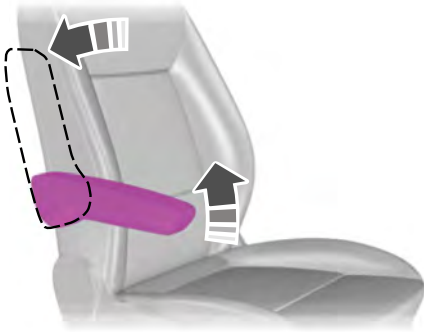

ADJUSTING THE LUMBAR SUPPORT - VEHICLES WITH: 4- WAY MANUAL SEAT



E146386

Front Seats

SWIVELING THE SEAT - VEHICLES WITH: 4-WAY MANUAL SEAT



WARNING: Make sure the seat locks into place and is facing forward when your vehicle is moving.

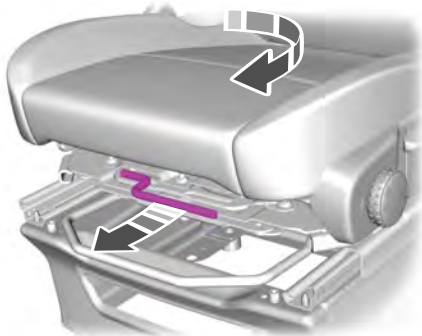

The seat can swivel through 180 degrees in an inboard direction.

You may need to adjust the seat to allow sufficient clearance for it to swivel in a single motion.

Note: We recommend that the seat is unoccupied.

Swivel Seat Audible Warning

Sounds when the driver or passenger seat is not locked into place, and the ignition is on.

POWER SEATS

HEADRESTRAINT COMPONENTS

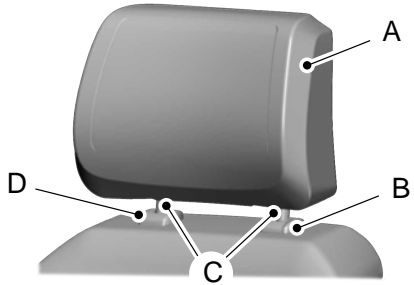

The head restraints consist of:

- A An energy absorbing head restraint.
- B Guide sleeve lock and release button.
- C Two steel stems.
- D Guide sleeve.

ADJUSTING THE HEAD RESTRAINT



WARNING: Fully adjust the head restraint before you sit in or operate your vehicle. This will help minimize the risk of neck injury in the event of a crash. Do not adjust the head restraint when your vehicle is moving.



WARNING: The head restraint is a safety device. Whenever possible it should be installed and properly adjusted when the seat is occupied. Failure to adjust the head restraint properly could reduce its effectiveness during certain impacts.

Front Seats



WARNING: Adjust the head restraints for all passengers before you drive your vehicle. This will help minimize the risk of neck injury in the event of a crash. Do not adjust the head restraints when your vehicle is moving.

Adjust the head restraint so that the top of it is level with the top of your head.

Raising the Head Restraints

1. Pull the head restraint upward.
2. Make sure that the head restraint locks into place.

Lowering the Head Restraints

1. Press and hold the locking button.
2. Push the head restraint downward.
3. Make sure that the head restraint locks into place.

REMOVING THE HEAD RESTRAINT



WARNING: Do not remove the head restraint from an occupied seat.

1. Do not remove the head restraint from an occupied seat.

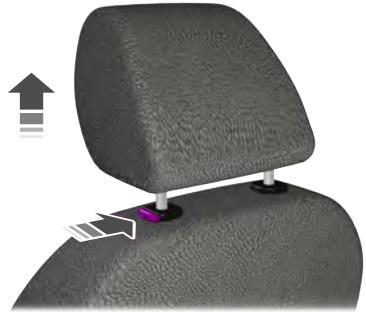

2. Press the locking button and remove the head restraint.

INSTALLING THE HEAD RESTRAINT

Align the steel stems into the guide sleeves and push the head restraint down until it locks.

MOVING THE SEAT BACKWARD AND FORWARD



WARNING: Do not adjust the driver seat or seat backrest when your vehicle is moving. This may result in sudden seat movement, causing the loss of control of your vehicle.



WARNING: Accessory seat covers not released by Ford Motor Company could prevent the seatbelt from retracting correctly. This could cause the seatbelt to become slack which could increase the risk of injuries in a crash.

Front Seats



ADJUSTING THE SEAT BACKREST

⚠ WARNING: Reclining the seat back can cause an occupant to slide under the seat's seatbelt, resulting in severe personal injuries in the event of a collision.



ADJUSTING THE SEAT HEIGHT

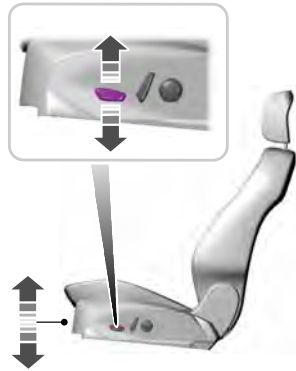

ADJUSTING THE LUMBAR SUPPORT



Front Seats

HEATED SEATS

HEATED SEAT PRECAUTIONS



WARNING: Use caution when using the heated seat if you are unable to feel pain to your skin because of advanced age, chronic illness, diabetes, spinal cord injury, medication, alcohol use, exhaustion or other physical conditions. The heated seat could cause burns even at low temperatures, especially if used for long periods of time. Failure to follow this instruction could result in personal injury.



WARNING: Do not poke sharp objects into the seat cushion or seat backrest. This could damage the heated seat element and cause it to overheat. Failure to follow this instruction could result in personal injury.



WARNING: Do not place anything on the seat that blocks the heat, for example a seat cover or a cushion. This could cause the seat to overheat. Failure to follow this instruction could result in personal injury.



Press the heated seat symbol to cycle through the various heat settings and off. The more indicators that display, the warmer the temperature of the seat.

Note: Based on your remote start settings, the heated seats may remain on after you remote start your vehicle. The heated seats may also turn on when you start your vehicle if they were on when you switched your vehicle off.

Automatic Heated Seats

When you switch on the auto setting, the heated seats switch on to match your climate control setting.

Do not:

- Place heavy objects on the seat.
- Operate the heated seat if water or any other liquid spills on the seat. Allow the seat to dry.

SWITCHING THE HEATED SEATS ON AND OFF

The vehicle must be on to use this feature.

Rear Seats

REAR SEAT PRECAUTIONS

WARNING: Do not use the bench seats as a bed when your vehicle is moving. Failure to follow this warning could result in serious personal injury or death.

WARNING: Do not place any objects on a folded seat. Hard objects may become projectiles in a crash or sudden stop, which may increase the risk of serious personal injury.

WARNING: When reclining the backrest forward and backward, take care not to get your hands caught between the seat backrest and the frame, catches or mechanism. Failure to take care may result in personal injury.

WARNING: Do not place cargo or any objects behind the seat backrest before returning it to the original position. Pull on the seat backrest to make sure that it has fully latched after returning the seat backrest to its original position. An unlatched seat may become dangerous if you stop suddenly or have a crash.

WARNING: When unfolding the seat backrests, make sure that the seatbelts are not trapped behind the seat.

MANUAL SEATS

HEADRESTRAINT COMPONENTS

Rear Seat Outermost Head Restraints

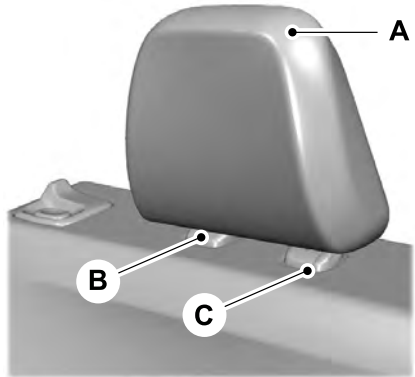

The head restraints consist of:

- A An energy absorbing head restraint.
- B Guide sleeve.
- C Locking guide sleeve.

Rear Seat Center Head Restraint

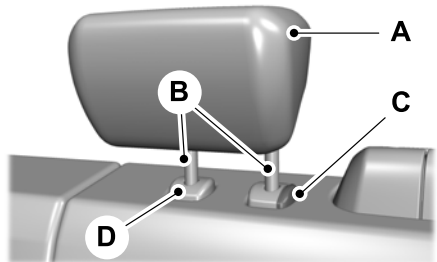

Rear Seats

The head restraint consists of:

- A An energy absorbing head restraint.
- B Two steel stems.
- C Guide sleeve adjust and release button.
- D Guide sleeve unlock and remove button (If equipped).

ADJUSTING THE HEAD RESTRAINT



WARNING: The head restraint is a safety device. Whenever possible it should be installed and properly adjusted when the seat is occupied. Failure to adjust the head restraint properly could reduce its effectiveness during certain impacts.



WARNING: Adjust the head restraints for all passengers before you drive your vehicle. This will help minimize the risk of neck injury in the event of a crash. Do not adjust the head restraints when your vehicle is moving.

Adjust the head restraint so that the top of it is level with the top of your head.

Pull the head restraint up to raise it.

To lower the head restraint:

1. Press and hold the adjust and release button.
2. Push the head restraint down.

REMOVING THE HEAD RESTRAINT

1. Fold the seat backrest forward before removing the head restraint.
2. Pull up the head restraint until it reaches its highest position.

3. Press and hold the adjust and release button and the unlock and remove button.
4. Pull up the head restraint.

INSTALLING THE HEAD RESTRAINT

1. Fold the seat backrest forward before installing the head restraint.
2. Align the steel stems into the guide sleeves and push the head restraint down until it locks.

ADJUSTING THE SEAT BACKREST



E175474

REMOVING THE SEATS



WARNING: Seats can weigh up to 132 lb (60 kg). Do not attempt to lift or carry any seat on your own.

Rear Seats



WARNING: Do not use the release handles to lift or carry the seat.

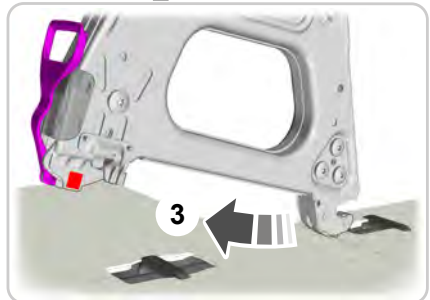
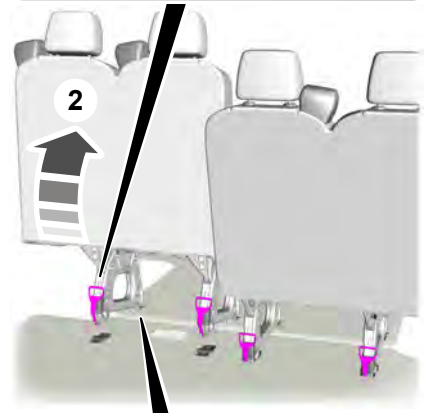
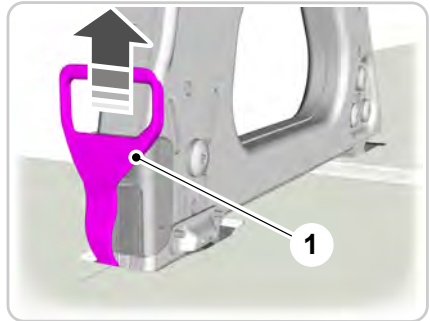

E173870

1. Pull the release handle up at an angle from the floor.

Rear Seats

2. While holding the handle in this position, tilt the top of the seat forward to release the seat frame rear catches from the floor.
3. When the rear seat latches are clear of the floor, release the handle.
4. Pull the seat backward to release the seat frame front catches.
5. Remove the seat from the vehicle.

Note: Two persons are required to release the seat handles and remove the seat.

Note: You can only remove seats that have integral release handles.

Note: The seatback does not fold forward.

INSTALLING THE SEATS



WARNING: Make sure that the floor catches are free from obstruction before installing the seats.



WARNING: Make sure that you securely fasten the seat catches when installing. Make sure that the latches are correctly engaged by checking the red latch indicators.



E178062

1. Align the seat frame front catches.
2. Push the seat forward to engage the seat frame front catches.
3. Align the seat frame rear catches.
4. Allow the seat to drop under its own weight for the last 6-8 in (15-20 cm).

Rear Occupant Alert System

WHAT IS THE REAR OCCUPANT ALERT SYSTEM

The rear occupant alert system monitors vehicle conditions and notifies you to check for rear seat occupants when you switch the ignition off.

HOW DOES THE REAR OCCUPANT ALERT SYSTEM WORK

The system monitors when rear doors have been opened and closed to indicate the potential presence of an occupant in the rear seat.

A message displays in the information and entertainment display screen and an audible warning sounds when you switch the ignition off after any of the following conditions have been met:

- A rear door is opened or closed while the ignition is on.
- You switch the ignition on within 15 minutes of a rear door opening and closing.
- You switch the ignition on within 15 minutes of the alert having displayed or sounded.

REAR OCCUPANT ALERT SYSTEM PRECAUTIONS



WARNING: On hot days, the temperature inside the vehicle can rise very quickly. Exposure of people or animals to these high temperatures for even a short time can cause death or serious heat related injuries, including brain damage. Small children are particularly at risk.



WARNING: Do not leave children or pets unattended in your vehicle. Failure to follow this instruction could result in personal injury or death.

REAR OCCUPANT ALERT SYSTEM LIMITATIONS

The system does not detect the presence of objects or passengers in the rear seat. It monitors when rear doors are opened and closed.

Note: *It is possible to receive an alert when there is no rear seat occupant, but alert conditions are met.*

Note: *It is possible to receive no alert when there is an occupant in the rear seat, if alert conditions are not met. For example, if a rear seat occupant does not enter the vehicle through a rear door.*

Note: *The audible warning does not sound when the front door is opened before you switch the vehicle off.*

SWITCHING REAR OCCUPANT ALERT SYSTEM ON AND OFF

1. Press **Settings** on the touchscreen.
2. Press **Vehicle**.
3. Switch **Rear Occupant Alert** on or off.

Note: *The default setting is on.*

Note: *Performing a system reset causes the system to switch on again.*

Semiannual Reminder (If Equipped)

When you switch the system off, a message appears every six months as a reminder that the system is off. You can switch the system back on or leave it off.

Rear Occupant Alert System

REAR OCCUPANT ALERT SYSTEM INDICATORS



Message
Check rear seats for occupants.

Displays when you switch your vehicle off after the alert conditions are met.

The message displays for a short period of time. Press **Close** to acknowledge and remove the message.

Note: Depending on your SYNC version, the graphic may look different from what you see here.

REAR OCCUPANT ALERT SYSTEM AUDIBLE WARNINGS

Sounds when you switch your vehicle off after the alert conditions are met.

The warning sounds for a short period of time.

USB Ports

LOCATING THE USB PORTS

Data Transfer USB Ports



The USB ports could be in the following locations:

- On the lower instrument panel.
- Inside the center console.

Note: *These USB ports can also charge devices.*

Note: *Not all USB ports in your vehicle have data transfer capabilities.*

Note: *We recommend using only USB-IF certified cables and adapters. Non-certified cables and adapters may not work.*

Charge Only USB Ports



The USB ports could be in the following locations:

- On the lower instrument panel.
- On the upper instrument panel.
- Inside the media bin.
- Inside the center console.
- On the rear of the center console.
- Behind the first row seats.
- In the cargo area.

PLAYING MEDIA USING THE USB PORT - VEHICLES WITH: SYNC 4



WARNING: Driving while distracted can result in loss of vehicle control, crash and injury. We strongly recommend that you use extreme caution when using any device that may take your focus off the road. Your primary responsibility is the safe operation of your vehicle. We recommend against the use of any hand-held device while driving and encourage the use of voice-operated systems when possible. Make sure you are aware of all applicable local laws that may affect the use of electronic devices while driving.

1. Connect your device to a data transfer USB port.
2. Press the audio system tile on the touchscreen.
3. Press **Sources**.



Press the USB option.



Press to play a track. Press again to pause the track.



Press to skip to the next track.

Press and hold to fast forward through the track.



Press once to return to the beginning of a track. Repeatedly press to return to previous

tracks.

Press and hold to fast rewind through the track.

USB Ports

CHARGING A DEVICE

Connect your device to the USB port.

Data Transfer USB Ports



You can charge your device through the data transfer USB port when SYNC is on.

Charge Only USB Ports



You can charge your device through the charge only USB port when the vehicle is in accessory mode or when the vehicle is running.

Power Outlet - Vehicles With: 110-120V Power Outlet

WHAT IS THE POWER OUTLET

The power outlet can power devices that require up to the rating on the outlet cover.

Note: *The total power delivered is divided if more than one outlet is used.*

POWER OUTLET PRECAUTIONS



WARNING: Do not keep electrical devices plugged into the power outlet whenever the device is not in use. The outlet provides power when the vehicle is on. Failure to follow this instruction could result in personal injury.



WARNING: Do not use an extension cord or connect multiple devices to the power outlet. Doing so could result in overloading the power outlet. Failure to follow this instruction could result in fire, personal injury or property damage.

Note: *This feature has a maximum output of 400 watts when the vehicle is in park (P).*

Note: *While in drive (D), the maximum outlet output is 300 watts.*

POWER OUTLET LIMITATIONS

Devices could exceed the power rating shown the device label when plugged in. Unplug the device and switch the ignition on and off to reset the system.

Do not use the power outlet for these types of electric devices:

- Cathode ray tube type televisions.
- Motor loads, for example vacuum cleaners, electric saws and other electric power tools, or compressor-driven refrigerators.

- Measuring devices which process precise data, for example medical equipment or measuring equipment.
- Other appliances requiring an extremely stable power supply, for example microcomputer-controlled electric blankets or touch sensor lamps.

LOCATING THE POWER OUTLETS

The power outlet could be located on both sides of the passenger seats.



POWER OUTLET INDICATORS

The power outlet indicator illuminates to let you know the status of the system.

Power Outlet - Vehicles With: 110-120V Power Outlet

Indicator Status	Description
On	The power outlet is on.
Off	The power outlet is off.
Flashing	The power outlet is in fault mode.

Note: *Due to different technologies used on its construction, some devices may exceed the capacity shown on its label when they are initially plugged in.*

Note: *The power outlet temporarily turns off power when in fault mode if the device exceeds the Watt limit. Unplug your device and switch the ignition off. Open the driver door to reset the power outlet. Switch the ignition back on and make sure the indicator light remains on. Do not plug your device back in if it exceeds the maximum outlet output.*

Power Outlet - Vehicles With: 110-120V 2.4kW Power Outlet

WHAT IS THE POWER OUTLET

The vehicle functions as a portable generator and can power devices that require up to the rating listed on power outlet label.

POWER OUTLET PRECAUTIONS



WARNING: Do not connect any vehicle power outlets to any premises. This can create a backfeed to utility lines. Failure to follow this instruction could result in property damage, fire, electrical shock or death.



WARNING: Do not keep electrical devices plugged in the power outlet whenever the device is not in use. Power outlets power up during remote start.

When you switch the rear power outlet on, the vehicle power down timer is disabled and the vehicle continues to be powered on.

Note: We recommend using UL approved devices for use with the power outlet.

Note: Make sure there is no damage to the outlets before driving your vehicle.

Note: Power could be limited during extreme hot or cold temperatures to optimize the performance of the system.

Note: Make sure the windows of the vehicle are closed and the doors are locked if you are using the outlets and leave your vehicle unattended.

Note: *Pro Power Onboard* is available when your vehicle is charging. Using the power outlets while the vehicle is charging could increase the vehicle charging time.

Grounding Type

Neutral bonded: The neutral of the inverter generator is bonded to system ground. Connecting loads that also have neutral bonded to ground causes the ground fault detection to trip.

Note: *If additional grounding measures are required, consult with a qualified electrician.*

LOCATING THE POWER OUTLETS

Front Location

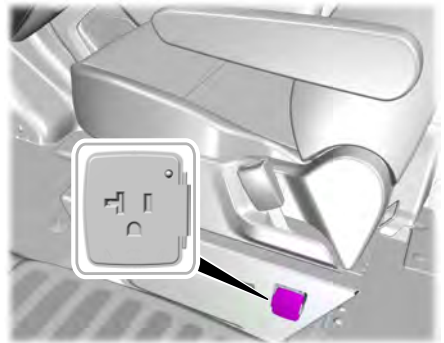

The front power outlet is on the inner side of the passenger seat.

Power Outlet - Vehicles With: 110-120V 2.4kW Power Outlet

Rear Location

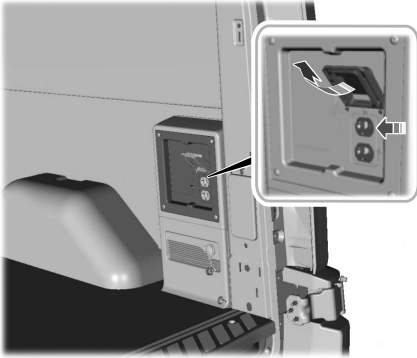

The rear power outlet could be in the rear of the vehicle.

POWER OUTLET INDICATORS

Power Outlet Status Indicator

The power outlet indicator illuminates to let you know the status of the system.

Indicator Status	Description
On	The power point is working and the vehicle is on.
Off	The power point is off and the vehicle is off.
Flashing	The power point is in fault mode.

Power Mode Indicator

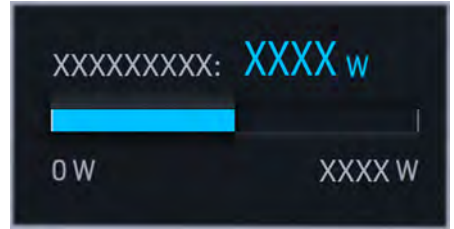

The power mode indicator displays the currently used power and total available power level on the touchscreen. When you switch the power outlets off, the indicator displays a reduced available power level. When you switch the power outlets on, the indicator displays the full available power.

Note: Make sure that plugged in devices do not exceed the available power displayed on the power mode indicator.

SWITCHING THE REAR POWER OUTLET ON AND OFF

Using the Center Display

1. Press **Features** on the touchscreen.
2. Press **Pro Power Onboard**.
3. Switch **Rear Outlets** on or off.

Power Outlet - Vehicles With: 110-120V 2.4kW Power Outlet

Using the Rear Outlet Control



Press the button to switch the rear outlet on and off.

SETTING THE HIGH VOLTAGE BATTERY RESERVE LIMIT

When the vehicle is in Park (P) you can set a high voltage battery reserve limit to save a range which you can drive your vehicle before recharging.

You can set the high voltage battery reserve limit on the touchscreen.

A notification indicates when the vehicle reaches the pre-set limit and **Pro Power Onboard** turns off.

Note: After your vehicle reaches the pre-set limit, the vehicle power down timer is enabled again. See **What Is the Vehicle Power Down Timer** (page 181).

RESETTING GROUND FAULT DETECTION

Disconnect all electrical loads before you reset the ground fault.

Use the controls on the touchscreen to test the ground fault detection circuit.

Power Outlet - Vehicles With: 110-120V 2.4kW Power Outlet

POWER OUTLET – TROUBLESHOOTING

POWER OUTLET – INFORMATION MESSAGES

Message	Description
Item(s) plugged in exceeded the system's maximum capacity. Try unplugging one or more items and reset. See owner's manual for details.	Make sure that plugged in devices do not exceed the available power displayed. Devices could exceed the power rating shown the device label when plugged in. Unplug the device and switch the vehicle on and off to reset the system.
Generator system is outside its operating temperature and capability is reduced. See owner's manual for details.	Power could be limited during extreme hot or cold temperatures to optimize the performance of the system.
Another power source is trying to supply power to your vehicle's AC outlets. Disconnect vehicle from that power source. See owner's manual for details.	Do not plug in any device that supplies power to the vehicle through the power outlets. This could result in damage to vehicle systems.
This button tests outlets for proper operation of ground fault detection. In a successful test, Pro Power Onboard detects the ground fault and turns off. See owner's manual for details.	The power outlet is in fault mode. Make sure that all devices are unplugged from the system. Use the controls on the touchscreen to reset the system. Switch your vehicle on and off if the touchscreen controls are unable to reset the system. See an authorized dealer if these steps do not fix the fault.

Power Outlet - Vehicles With: 110-120V 2.4kW Power Outlet

POWER OUTLET – FREQUENTLY ASKED QUESTIONS

Why is there a warning about something being plugged into the rear power outlet when I do not have anything plugged in?

- One or more of the rear power outlet covers could be ajar or broken. Make sure the generator is off and check the outlet covers. Select OK on the instrument cluster display to acknowledge the warning.

Why can I not shift my vehicle out of Park (P)?

- Make sure the rear power outlet covers are closed and not damaged. Press OK on the instrument cluster display to acknowledge the warning to be able to move the transmission from Park (P).

What do I do when my instrument cluster display is malfunctioning and I cannot acknowledge the warning to put the transmission in Drive (D).

- Power the vehicle off and make sure nothing is plugged into the rear power outlet and all outlet covers are closed. Start the vehicle and select OK on the instrument cluster display to acknowledge the warning. Have your vehicle serviced soon.

Power Outlet - Vehicles With: 12V Power Outlet

WHAT IS THE POWER OUTLET

The power outlet can power devices using a 12 V outlet adapter.

POWER OUTLET PRECAUTIONS



WARNING: Do not use a power point for operating a cigar lighter. Incorrect use of the power points can cause damage not covered by the vehicle warranty, and can result in fire or serious injury.

When you switch the vehicle on, you can use the socket to power 12 V appliances with a maximum current rating of 15 A. Do not use the power point over the vehicle capacity of 12 V DC 180 W or a fuse could blow. Do not plug in any device that supplies power to the vehicle through the power points. This could result in damage to vehicle systems. Do not hang any accessory from the accessory plug. Always keep the power point caps closed when not in use. Do not insert objects other than an accessory plug into the power point.

To prevent the battery from running out of charge:

- Do not use the power point longer than necessary when the vehicle is off.
- Do not leave devices plugged in overnight or when you park your vehicle for extended periods.

LOCATING THE POWER OUTLETS

Power outlets could be in the following locations:

- On the instrument panel.
- Inside the center console.
- On the rear of the center console.
- Inside the cargo area.

Cigar Lighter

CIGAR LIGHTER PRECAUTIONS



WARNING: Do not plug optional electrical accessories into the cigar lighter socket. Incorrect use of the cigar lighter can cause damage not covered by the vehicle warranty, and can result in fire or serious injury.

Note: *If the power supply does not work after you switch the ignition off, switch the ignition on.*

Note: *If you use the socket when the engine is not running, the battery may run out of charge.*

Note: *When you switch the ignition on, you can use the socket to power 12 V appliances with a maximum current rating of 15 A.*

USING THE CIGAR LIGHTER



E103382

Press the element in to use the cigar lighter. It pops out after a short period of time.

Do not hold the cigar lighter element pressed in.

Storage (If Equipped)

BOTTLE HOLDERS

BOTTLE HOLDER PRECAUTIONS



WARNING: Do not place glass objects in the bottle holder. Items could become loose during hard braking, acceleration or crashes. Failure to follow this instruction could result in personal injury.



E169073

LOCATING THE BOTTLE HOLDERS



OVERHEAD STORAGE LOAD CAPACITIES

The maximum evenly distributed shelf load is 44 lb (20 kg).

OVERHEAD STORAGE

LOCATING THE OVERHEAD STORAGE



WARNING: Do not place heavy objects in the overhead console. Failure to follow this instruction could result in personal injury or death in the event of a sudden stop or crash.

Starting and Stopping the Engine - Gasoline

STARTING AND STOPPING THE ENGINE – PRECAUTIONS

WARNING: Do not use starting fluid, for example ether, in the air intake system. Such fluid could cause immediate explosive damage to the engine and possible personal injury.

WARNING: Exhaust leaks may result in entry of harmful and potentially lethal fumes into the passenger compartment. If you smell exhaust fumes inside your vehicle, have your vehicle inspected immediately. Do not drive if you smell exhaust fumes.

WARNING: Extended idling at high engine speeds can produce very high temperatures in the engine and exhaust system, creating the risk of fire or other damage.

WARNING: Do not park, idle or drive your vehicle on dry grass or other dry ground cover. The emission system heats up the engine compartment and exhaust system, creating the risk of fire.

WARNING: Do not start the engine in a closed garage or in other enclosed areas. Exhaust fumes are toxic. Always open the garage door before you start the engine. Failure to follow this instruction could result in personal injury or death.

If you stop your vehicle and then leave the engine idling for long periods, we recommend that you do one of the following:

- Open the windows at least 1 in (3 cm).
- Set your climate control to outside air.

IGNITION SWITCH



Note: Make sure the key is clean before inserting it into any lock cylinder.

Note: Do not leave the key in the ignition for an extended period of time when the engine is not running. This is to prevent the vehicle battery from losing charge.

Switching the Ignition Off

Turn the key to position **0**.

Switching the Ignition to Accessory Mode

Turn the key to position **I**. Electrical accessories, for example the radio, operate without the engine running.

Switching the Ignition On

Turn the key to position **II**. All electrical circuits and accessories are operational and the warning lamps and indicators illuminate.

Starting and Stopping the Engine - Gasoline

Starting the Engine

Turn the key to position **III**. Release the key when the engine starts.

PUSH BUTTON IGNITION SWITCH



Switching the Ignition Off

When the ignition is on or in accessory mode, press the push button ignition switch once without your foot on the brake or clutch pedal.

Switching the Ignition to Accessory Mode

When the ignition is off, press the push button ignition switch once without your foot on the brake or clutch pedal.

All electrical circuits and accessories are operational and the warning lamps and indicators illuminate.

Note: Your vehicle has a battery saver feature that shuts your vehicle off when it detects a certain amount of battery drain or inactivity in accessory mode.

Starting the Engine

Press the brake or clutch pedal and press the push button ignition switch. An indicator light on the button illuminates when the ignition is on and when the engine starts.

Note: The system may not function if the passive key is close to metal objects or electronic devices, for example keys or a cell phone.

Note: A valid key must be inside your vehicle to switch the ignition on and start the engine.

STARTING THE ENGINE

STARTING A GASOLINE ENGINE - VEHICLES WITH: KEYED IGNITION

Before starting your vehicle, check the following:

- Make sure that the headlamps and electrical accessories are off.
 - Make sure that the parking brake is on.
 - Make sure that the transmission is in park (P).
1. Fully press the brake pedal.

Note: Do not touch the accelerator pedal.



2. Turn the key to position **III**.

Note: The engine may continue cranking for up to 15 seconds or until it starts.

Note: The engine takes longer to start at lower temperatures. It may crank for several seconds when very cold.

STARTING A GASOLINE ENGINE - VEHICLES WITH: PUSH BUTTON START

Before starting your vehicle, check the following:

- Make sure that the headlamps and electrical accessories are off.
- Make sure that the parking brake is on.
- Make sure that the transmission is in park (P).

Starting and Stopping the Engine - Gasoline

1. Fully press the brake pedal.

Note: Do not touch the accelerator pedal.



2. Press the push button ignition switch.

Note: The engine may continue cranking for up to 15 seconds or until it starts.

Note: The engine takes longer to start at lower temperatures. It may crank for several seconds when very cold.

RESTARTING THE ENGINE AFTER STOPPING IT

The system allows you to start the engine within 10 seconds of switching it off, even if it does not detect a valid passive key.

Within 10 seconds of switching the engine off, fully press the brake or clutch pedal and press the push button ignition switch. After 10 seconds, you can no longer start the engine if the system does not detect a valid passive key.

When you start the engine, it remains running until you press the push button ignition switch, even if your vehicle does not detect a valid passive key. If you open and close a door when the engine is running, the system searches for a valid passive key.

STARTING A FLOODED ENGINE - VEHICLES WITH: KEYED IGNITION

If you cannot start the engine after 3 attempts, wait 10 seconds and do the following:

1. Fully press the brake pedal or the clutch pedal.

Note: Make sure that the parking brake is applied.

Note: Make sure that the transmission is in park (P) or neutral (N).

2. Fully press the accelerator pedal and hold it there.



3. Turn the key to position **III** and wait until the engine stops cranking.
4. Release the accelerator pedal.
5. Turn the key to position **III**.

STARTING A FLOODED ENGINE - VEHICLES WITH: PUSH BUTTON START

If you cannot start the engine after 3 attempts, wait 10 seconds and do the following:

1. Fully press the brake pedal or the clutch pedal.

Note: Make sure that the parking brake is applied.

Note: Make sure that the transmission is in park (P) or neutral (N).

2. Fully press the accelerator pedal and hold it there.
3. Press the push button ignition switch.

Note: The engine cranks for a short period of time and then it stops.

4. Release the accelerator pedal.



Starting and Stopping the Engine - Gasoline

5. Press the push button ignition switch.

ENGINE BLOCK HEATER

ENGINE BLOCK HEATER PRECAUTIONS



WARNING: Failure to follow engine block heater instructions could result in property damage or serious personal injury.



WARNING: Do not use your heater with ungrounded electrical systems or two-pronged adapters. There is a risk of electrical shock.



WARNING: Do not fully close the hood, or allow it to drop under its own weight when using the engine block heater. This could damage the power cable and may cause an electrical short resulting in fire, injury and property damage.

- Make sure that when in operation, the extension cord plug and engine block heater cord plug connections are free and clear of water. This could cause an electric shock or fire.
- If the engine block heater cord is under the hood, do not remove the wiring from its original location. Do not close the hood on the extension wiring.
- Park your vehicle in a clean area, clear of combustible materials.
- Firmly connect the engine block heater cord and the extension cord.
- Check the extension cord for heat anywhere when the system has been operating for approximately 30 minutes.
- Unplug and properly stow the system before starting and driving your vehicle. The protective cover seals the terminals of the engine block heater cord plug when not in use.
- Check the engine block heater system for proper operation before winter.

We recommend that you do the following for a safe and correct operation:

- Use a 16-gauge outdoor extension cord that is product certified by Underwriter's Laboratory (UL) or Canadian Standards Association (CSA). This extension cord must be suitable for use outdoors, in cold temperatures, and be clearly marked Suitable for Use with Outdoor Appliances. Do not use an indoor extension cord outdoors. This could result in an electric shock or become a fire hazard.
- Use as short an extension cord as possible.
- Do not use multiple extension cords.

HOW DOES THE ENGINE BLOCK HEATER WORK

The engine block heater warms the engine coolant. This allows the climate control system to quickly respond. The equipment includes a heater element installed in the engine block and a wire harness. You can connect the system to a grounded 110 volt AC electrical source.

Note: *The engine block heater is most effective when outdoor temperatures are below 0°F (-18°C). We recommend the use of engine block heater to improve engine cold start performance.*

Starting and Stopping the Engine - Gasoline

USING THE ENGINE BLOCK HEATER

Make sure the receptacle terminals are clean and dry prior to use. Clean them with a dry cloth if necessary.

The heater uses 0.4 to 1.0 kilowatt-hours of energy per hour of use. The system does not have a thermostat. It achieves maximum temperature after approximately three hours of operation. Using the engine block heater longer than three hours does not improve system performance and unnecessarily uses electricity.

STOPPING THE ENGINE

STOPPING THE ENGINE WHEN YOUR VEHICLE IS STATIONARY - VEHICLES WITH: KEYED IGNITION

1. Shift into park (P).
2. Apply the parking brake.
3. Wait until the engine reaches idle speed.

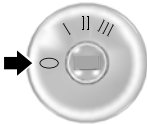

4. Turn the key to position **0**.

STOPPING THE ENGINE WHEN YOUR VEHICLE IS STATIONARY - VEHICLES WITH: PUSH BUTTON START

1. Shift into park (P).
2. Apply the parking brake.
3. Wait until the engine reaches idle speed.



4. Press the push button ignition switch.

STOPPING THE ENGINE WHEN YOUR VEHICLE IS MOVING - VEHICLES WITH: KEYED IGNITION



WARNING: Switching off the engine when your vehicle is still moving results in a significant decrease in braking assistance. Higher effort is required to apply the brakes and to stop your vehicle. A significant decrease in steering assistance could also occur. The steering does not lock, but higher effort could be required to steer your vehicle. When you switch the ignition off, some electrical circuits, for example airbags, also turn off. If you unintentionally switch the ignition off, shift into neutral (N) and restart the engine.

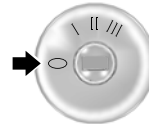

1. Turn the key to position **0**.
2. Shift into neutral and use the brakes to bring your vehicle to a safe stop.
3. Shift into park (P).
4. Apply the parking brake.

Starting and Stopping the Engine - Gasoline

STOPPING THE ENGINE WHEN YOUR VEHICLE IS MOVING - VEHICLES WITH: PUSH BUTTON START



WARNING: Switching off the engine when your vehicle is still moving results in a significant decrease in braking assistance. Higher effort is required to apply the brakes and to stop your vehicle. A significant decrease in steering assistance could also occur. The steering does not lock, but higher effort could be required to steer your vehicle. When you switch the ignition off, some electrical circuits, for example airbags, also turn off. If you unintentionally switch the ignition off, shift into neutral (N) and restart the engine.



1. Press and hold the push button ignition switch until the engine stops, or press it three times within two seconds.
2. Shift into neutral and use the brakes to bring your vehicle to a safe stop.
3. Shift into park (P).
4. Apply the parking brake.

AUTOMATIC ENGINE STOP - VEHICLES WITH: PUSH BUTTON START

WHAT IS AUTOMATIC ENGINE STOP

Automatic engine stop automatically shuts down your vehicle if it has been idling for an extended period of time. The ignition also turns off in order to save battery power.

HOW DOES AUTOMATIC ENGINE STOP WORK

Before your vehicle shuts down, a message appears in the information display showing a timer counting down from 30 seconds. If you do not intervene within 30 seconds, your vehicle shuts down.

After the shutdown, another message appears in the information display to inform you that your vehicle has shut down in order to save fuel.

Start your vehicle as normal.

SWITCHING AUTOMATIC ENGINE STOP ON AND OFF

1. Using the information display controls on the steering wheel, select **Settings**.
2. Select **Vehicle Settings**.
3. Switch **30min Max Idle** on or off.

Note: You cannot permanently switch off the automatic shutdown. If you switch it off, it turns on each time you switch the ignition on.

Starting and Stopping the Engine - Gasoline

OVERRIDING AUTOMATIC ENGINE STOP

You can stop the shutdown, or reset the timer, at any point before the 30-second countdown has expired by doing any of the following:

- Pressing the brake or accelerator pedal.
- Pressing the **OK** or **Reset** button during the 30-second countdown.

ACCESSING THE PASSIVE KEY BACKUP POSITION

If you are unable to start your vehicle, follow the steps below.



1. Place the remote control in the instrument panel slot as shown with the buttons facing upward.
2. Press and hold the brake pedal.
3. Press the push button start to switch the power on and start your vehicle.

STARTING AND STOPPING THE ENGINE – TROUBLESHOOTING

STARTING AND STOPPING THE ENGINE – WARNING LAMPS



Malfunction Indicator Lamp
Check Engine

If it illuminates when the engine is running this indicates a malfunction. The On Board Diagnostics system has detected a malfunction of the vehicle emission control system.

If it flashes, engine misfire may be occurring. Increased exhaust gas temperatures could damage the catalytic converter or other vehicle components. Avoid heavy acceleration and deceleration and have your vehicle immediately serviced.



Powertrain Warning Lamp

If it illuminates when the engine is running this indicates a malfunction. If it flashes when you are driving, immediately reduce the vehicle speed. Avoid heavy acceleration and deceleration and have your vehicle immediately serviced.

If both lamps illuminate when the engine is running, stop your vehicle as soon as it is safe to do so. Continuing to drive your vehicle may cause reduced power or the engine to stop. Switch the ignition off and attempt to restart the engine. Have your vehicle immediately checked.

Starting and Stopping the Engine - Gasoline

STARTING AND STOPPING THE ENGINE – INFORMATION MESSAGES

Message	Details
Cranking Time Exceeded	Displays if you exceed the starting time limit. You cannot attempt to start the engine for 15 minutes. If you cannot start the engine after 15 minutes passes, have your vehicle immediately checked.
Starting System Fault	Displays if you are unable to start your vehicle with a correctly coded key. The system has detected a fault that requires service. Have your vehicle checked as soon as possible.
No Key Detected	Displays if the system does not detect a valid passive key.

Starting and Stopping the Engine - Gasoline

STARTING AND STOPPING THE ENGINE – FREQUENTLY ASKED QUESTIONS - VEHICLES WITH: KEYED IGNITION

Why is the engine idle speed high when I am starting the engine?

- The speed at which the engine idles immediately after starting is optimized to minimize vehicle emissions and maximize cabin comfort and fuel economy.

Why does the engine not crank?

- You can only attempt to start the engine for a limited amount of time before the starting system temporarily disables. If you exceed the starting time limit, a message may appear and you cannot attempt to start the engine for at least 15 minutes.

Why do I experience different driving characteristics?

- If you disconnect the battery, your vehicle may exhibit some unusual driving characteristics for approximately 5 mi (8 km) after you reconnect it. This is because the engine management system must realign itself with the engine. You can disregard any unusual driving characteristics during this period.

Why can I not start the engine?

If you cannot start the engine after 3 attempts, wait 10 seconds and do the following:

1. Fully press the brake pedal or the clutch pedal.

Note: Make sure that the parking brake is applied.

Note: Make sure that the transmission is in park (P) or neutral (N).

2. Fully press the accelerator pedal and hold it there.



3. Turn the key to position III and wait until the engine stops cranking.
4. Release the accelerator pedal.
5. Turn the key to position III.

STARTING AND STOPPING THE ENGINE – FREQUENTLY ASKED QUESTIONS - VEHICLES WITH: PUSH BUTTON START

Why is the engine speed high when I am starting the engine?

- The speed at which the engine idles immediately after starting is optimized to minimize vehicle emissions and maximize cabin comfort and fuel economy.

Why does the engine not crank?

- You can only attempt to start the engine for a limited amount of time before the starting system temporarily disables. If you exceed the starting time limit, a message may appear and you cannot attempt to start the engine for at least 15 minutes.

Starting and Stopping the Engine - Gasoline

Why do I experience different driving characteristics?

- If you disconnect the battery, your vehicle may exhibit some unusual driving characteristics for approximately 5.0 mi (8 km) after you reconnect it. This is because the engine management system must realign itself with the engine. You can disregard any unusual driving characteristics during this period.

Why can I not start the engine?

If you cannot start the engine after 3 attempts, wait 10 seconds and do the following:

1. Fully press the brake pedal or the clutch pedal.

Note: *Make sure that the parking brake is applied.*

Note: *Make sure that the transmission is in park (P) or neutral (N).*

2. Fully press the accelerator pedal and hold it there.
3. Press the push button ignition switch.

Note: *The engine cranks for a short period of time and then it stops.*

4. Release the accelerator pedal.



5. Press the push button ignition switch.

Why does the system not detect a passive key?

- If the system does not detect a passive key and you are unable to start the engine, insert the passive key into the backup position and press the push button ignition switch to start the engine. See **Accessing the Passive Key Backup Position** (page 176).

Starting and Powering Off - Battery Electric Vehicle

STARTING AND POWERING OFF PRECAUTIONS

- The system may not function if the remote control is close to metal objects or electronic devices, such as keys or a cell phone.
- A valid remote control must be inside your vehicle to switch the power on and start your vehicle.
- Remote controls left inside your vehicle when locked are disabled. A message may appear in the information display indicating that there is no key detected when you try to start your vehicle. Press the unlock button on the remote control to enable it, and then start your vehicle.
- Make sure all occupants fasten their seat belt.
- Make sure the headlamps and electrical accessories are off.
- Make sure the parking brake is on.
- Make sure the vehicle is in park (P).
- Make sure there is no charge cord coupler connected to the vehicle.

STARTING THE VEHICLE

1. Fully press the brake pedal.

Note: Do not touch the accelerator pedal.



2. Press the push button start.

POWERING OFF



WARNING: Do not switch off your vehicle when it is moving. This results in a significant decrease in braking and steering assistance. If the vehicle is switched off, some electrical circuits, for example airbags, could also turn off. Failure to follow this instruction could result in the loss of control of your vehicle, personal injury or death.

Note: If you unintentionally switch your vehicle off, shift into neutral (N) and restart your vehicle.

When your vehicle is not moving and is started, or the power is in accessory mode, press and release the push button start without pressing the brake pedal. This shuts off the vehicle and all electrical accessories.

Only in a case of emergency, when your vehicle is moving, press the push button start three times within two seconds, or press and hold for at least one second. Shift into neutral (N) and use the brakes to bring your vehicle to a safe stop. When your vehicle comes to a complete stop, shift into park (P).

RESTARTING THE VEHICLE AFTER POWERING OFF

Fast Restart

The fast restart feature allows you to restart your vehicle within 10 seconds of switching it off, even if it does not detect a valid remote control.

Starting and Powering Off - Battery Electric Vehicle

Within 10 seconds of switching your vehicle off, press the brake pedal and press the push button start. After 10 seconds, you can no longer start your vehicle if it does not detect a valid remote control.

Once your vehicle starts, it remains on until you press the push button start, even if it does not detect a valid remote control.

If you open and close a door while your vehicle is on, the system searches for a valid remote control. You cannot start your vehicle if the system does not detect a valid remote control within 10 seconds.

VEHICLE POWER DOWN TIMER

WHAT IS THE VEHICLE POWER DOWN TIMER

Vehicle power down timer automatically shuts down your vehicle if it has been idling for an extended period of time. The ignition also turns off in order to save battery power.

HOW DOES THE VEHICLE POWER DOWN TIMER WORK

Before your vehicle shuts down, a message appears in the information display showing a timer counting down from 30 seconds. If you do not intervene within 30 seconds, your vehicle shuts down.

After the shutdown, another message appears in the information display to inform you that your vehicle has shut down in order to save battery power.

Start your vehicle as normal.

SWITCHING THE VEHICLE POWER DOWN TIMER ON AND OFF

1. Press **Settings** on the touchscreen.
2. Press **Vehicle Settings**.

3. Switch **Vehicle Power Down Timer** on or off.

Note: You cannot permanently switch off the vehicle power down timer. If you switch it off, it turns on each time you switch the vehicle on.

OVERRIDING THE VEHICLE POWER DOWN TIMER

You can stop the shutdown or reset the timer before the 30-second countdown has expired by doing any of the following:

- Pressing the brake or accelerator pedal.
- Pressing the **OK** or **RESET** button during the 30-second countdown.

ACCESSING THE PASSIVE KEY BACKUP POSITION

If you are unable to start your vehicle, follow the steps below.

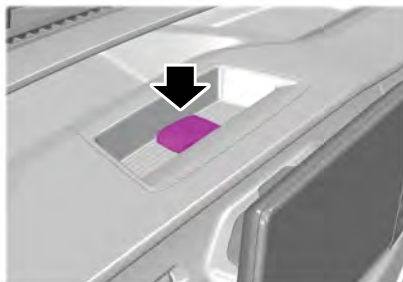

1. Place the remote control in the instrument panel slot as shown with the buttons facing upward.
2. Press and hold the brake pedal.
3. Press the push button start to switch the power on and start your vehicle.

STARTING AND POWERING OFF – TROUBLESHOOTING

STARTING AND POWERING OFF – FREQUENTLY ASKED QUESTIONS

Why does the vehicle not start?

- The system does not function if the remote control frequencies are jammed, or if the remote control battery has no charge. See **Accessing the Passive Key Backup Position** (page 181).

Fuel and Refueling

FUEL AND REFUELING PRECAUTIONS



WARNING: Do not overfill the fuel tank. The pressure in an overfilled tank may cause leakage and lead to fuel spray and fire.



WARNING: The fuel system may be under pressure. If you hear a hissing sound near the fuel filler inlet, do not refuel until the sound stops. Otherwise, fuel may spray out, which could cause serious personal injury.



WARNING: Fuels can cause serious injury or death if misused or mishandled.



WARNING: Fuel may contain benzene, which is a cancer-causing agent.



WARNING: When refueling always shut the engine off and never allow sparks or open flames near the fuel tank filler valve. Never smoke or use a cell phone while refueling. Fuel vapor is extremely hazardous under certain conditions. Avoid inhaling excess fumes.



WARNING: Read and follow all the instructions on the pump island.

Follow these guidelines when refueling:

- Extinguish all smoking materials and any open flames before refueling your vehicle.
- Switch the engine off before refueling.
- Automotive fuels can be harmful or fatal if swallowed. Fuel is highly toxic and if swallowed can cause death or permanent injury. If fuel is swallowed immediately call a physician, even if no symptoms are immediately apparent. The toxic effects of fuel may not be apparent for hours.
- Avoid inhaling fuel vapors. Inhaling fuel vapor can lead to eye and respiratory tract irritation. In severe cases, excessive or prolonged breathing of fuel vapor can cause serious illness and permanent injury.
- Avoid getting fuel in your eyes. If you splash fuel in your eyes, immediately remove contact lenses, if worn, flush with water for 15 minutes and seek medical attention. Failure to seek proper medical attention could lead to permanent injury.
- Fuels can be harmful if absorbed through the skin. If you splash fuel on your skin, clothing or both, promptly remove contaminated clothing and thoroughly wash your skin with soap and water. Repeated or prolonged skin contact causes skin irritation.
- Be particularly careful if you are taking Antabuse or other forms of Disulfiram for the treatment of alcoholism. Breathing fuel vapors could cause an adverse reaction, serious personal injury or sickness. Immediately call a physician if you experience any adverse reactions.

Fuel and Refueling

FUEL QUALITY

SELECTING THE CORRECT FUEL - 3.5L DURATEC, E85

Flex fuel vehicles have one of the following identifiers:

- Yellow fuel filler cap.
- Yellow bezel around the fuel filler inlet.
- Yellow fuel filler housing.
- Yellow E85 label on the fuel tank filler door.

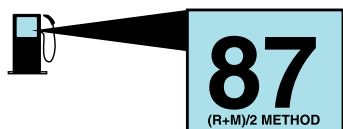

Your vehicle is designed to operate on regular unleaded gasoline with a minimum pump (R+M)/2 octane rating of 87 or regular unleaded gasoline blended with a maximum of 85% ethanol (E85).

Some fuel stations, particularly those in high altitude areas, offer fuels posted as regular unleaded gasoline with an octane rating below 87. The use of these fuels could result in engine damage that will not be covered by the vehicle warranty.

For best overall vehicle and engine performance, premium fuel with an octane rating of 91 or higher is recommended. The performance gained by using premium fuel is most noticeable in hot weather as well as other conditions, for example when towing a trailer.

Do not be concerned if the engine sometimes knocks lightly. However, if the engine knocks heavily while using fuel with the recommended octane rating, contact an authorized dealer to prevent any engine damage.

We recommend Top Tier detergent gasolines, where available to help minimize engine deposits and maintain optimal vehicle and engine performance. For additional information, refer to www.toptiergas.com.

Note: *Use of any fuel for which the vehicle was not designed can impair the emission control system, cause loss of vehicle performance, and cause damage to the engine which may not be covered by the vehicle Warranty.*

Do not use:

- Diesel fuel.
- Fuels containing kerosene or paraffin.
- Fuels containing more than 85% ethanol or E100 fuel.
- Fuels containing methanol.
- Fuels containing metallic-based additives, including manganese-based compounds.
- Fuels containing the octane booster additive, methylcyclopentadienyl manganese tricarbonyl (MMT).
- Leaded fuel, using leaded fuel is prohibited by law.

The use of fuels with metallic compounds such as methylcyclopentadienyl manganese tricarbonyl (commonly known as MMT), which is a manganese-based fuel additive, will impair engine performance and affect the emission control system.

Fuel and Refueling

SELECTING THE CORRECT FUEL - GASOLINE

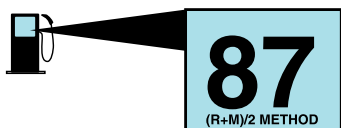

Your vehicle is designed to operate on regular unleaded gasoline with a minimum pump (R+M)/2 octane rating of 87.

Some fuel stations, particularly those in high altitude areas, offer fuels posted as regular unleaded gasoline with an octane rating below 87. The use of these fuels could result in engine damage that will not be covered by the vehicle warranty.

For best overall vehicle and engine performance, premium fuel with an octane rating of 91 or higher is recommended. The performance gained by using premium fuel is most noticeable in hot weather as well as other conditions, for example when towing a trailer.

Do not be concerned if the engine sometimes knocks lightly. However, if the engine knocks heavily while using fuel with the recommended octane rating, contact an authorized dealer to prevent any engine damage.

We recommend Top Tier detergent gasolines, where available to help minimize engine deposits and maintain optimal vehicle and engine performance. For additional information, refer to www.toptiergas.com.

Note: Use of any fuel for which the vehicle was not designed can impair the emission control system, cause loss of vehicle performance, and cause damage to the engine which may not be covered by the vehicle Warranty.

Do not use:

- Diesel fuel.
- Fuels containing kerosene or paraffin.
- Fuel containing more than 15% ethanol or E85 fuel.
- Fuels containing methanol.
- Fuels containing metallic-based additives, including manganese-based compounds.
- Fuels containing the octane booster additive, methylcyclopentadienyl manganese tricarbonyl (MMT).
- Leaded fuel, using leaded fuel is prohibited by law.

The use of fuels with metallic compounds such as methylcyclopentadienyl manganese tricarbonyl (commonly known as MMT), which is a manganese-based fuel additive, will impair engine performance and affect the emission control system.

SWITCHING BETWEEN E85 AND GASOLINE - 3.5L DURATEC

We do not recommend repeatedly alternating between E85 and gasoline. If you switch from using E85 to gasoline, or from gasoline to E85, add as much fuel as possible, at least half a tank. Drive your vehicle immediately for a minimum of 5 mi (8 km) to allow it to adapt to the change in ethanol concentration. If you use E85 exclusively, we recommend that you fill the fuel tank with regular unleaded gasoline at each scheduled oil change.

Fuel and Refueling

LOCATING THE FUEL FILLER FUNNEL

The fuel filler funnel is in the glove compartment or in the front right-hand side stepwell storage compartment.

RUNNING OUT OF FUEL

FILLING A PORTABLE FUEL CONTAINER

WARNING: Flow of fuel through a fuel pump nozzle can produce static electricity. This can cause a fire if you are filling an ungrounded fuel container.

Use the following guidelines to avoid electrostatic charge build-up, which can produce a spark, when filling an ungrounded fuel container:

- Only use an approved fuel container to transfer fuel to your vehicle. Place the container on the ground when filling it.
- Do not fill a fuel container when it is inside your vehicle (including the cargo area).
- Keep the fuel pump nozzle in contact with the fuel container when filling it.
- Do not use a device that holds the fuel pump nozzle lever in the fill position.

ADDING FUEL FROM A PORTABLE FUEL CONTAINER

WARNING: Do not insert the nozzle of a fuel container or an aftermarket funnel into the fuel filler neck. This may damage the fuel system filler neck or its seal and cause fuel to run onto the ground.

WARNING: Do not pry open the fuel tank filler valve. This could damage the fuel system. Failure to follow this instruction could result in fire, personal injury or death.

WARNING: Do not dispose of fuel in the household refuse or the public sewage system. Use an authorized waste disposal facility.

When refueling the vehicle fuel tank from a fuel container, use the fuel filler funnel included with your vehicle. See **Locating the Fuel Filler Funnel** (page 186).

Note: Do not use aftermarket funnels as they may not work with the capless fuel system and can damage it.

When refueling the vehicle fuel tank from a fuel container, do the following:

1. Fully open the fuel filler door.



2. Fully insert the fuel filler funnel into the fuel filler inlet.
3. Add fuel to your vehicle from the fuel container.
4. Remove the fuel filler funnel.
5. Fully close the fuel filler door.

Fuel and Refueling

- Clean the fuel filler funnel and place it back in your vehicle or correctly dispose of it.

Note: If your vehicle runs out of fuel add a minimum of 1.3 gal (5 L) of fuel to restart the engine.

Note: You may need to switch the ignition from off to on several times after refueling to allow the fuel system to pump the fuel from the tank to the engine. When restarting, cranking time takes a few seconds longer than normal.

Note: Extra funnels can be purchased from an authorized dealer if you choose to dispose of the funnel.

REFUELING

REFUELING SYSTEM OVERVIEW

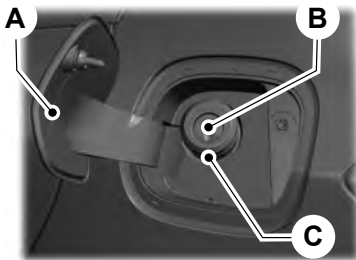

- A Fuel filler door.
- B Fuel filler inlet.
- C Fuel tank filler pipe.

REFUELING YOUR VEHICLE

WARNING: When refueling always shut the engine off and never allow sparks or open flames near the fuel tank filler valve. Never smoke or use a cell phone while refueling. Fuel vapor is extremely hazardous under certain conditions. Avoid inhaling excess fumes.

WARNING: The fuel system may be under pressure. If you hear a hissing sound near the fuel filler inlet, do not refuel until the sound stops. Otherwise, fuel may spray out, which could cause serious personal injury.

WARNING: Fuel vapor burns violently and a fuel fire can cause severe injuries.

WARNING: Keep children away from the fuel pump. Never let children pump fuel.

WARNING: Stay outside your vehicle and do not leave the fuel pump unattended when refueling your vehicle.

WARNING: Do not pry open the fuel tank filler valve. This could damage the fuel system. Failure to follow this instruction could result in fire, personal injury or death.

WARNING: Do not remove the fuel pump nozzle from its fully inserted position when refueling.

WARNING: Stop refueling when the fuel pump nozzle automatically shuts off for the first time. Failure to follow this will fill the expansion space in the fuel tank and could lead to fuel overflowing.

Fuel and Refueling

WARNING: Do not overfill the fuel tank. The pressure in an overfilled tank may cause leakage and lead to fuel spray and fire.

WARNING: Wait at least five seconds before removing the fuel pump nozzle to allow any residual fuel to drain into the fuel tank.

WARNING: Read and follow all the instructions on the pump island.

1. Open the fuel filler door.
2. Select the correct fuel pump nozzle for your vehicle.

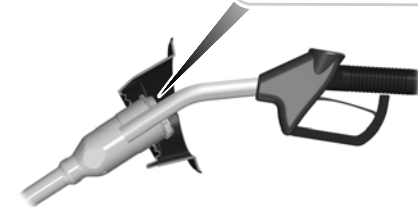
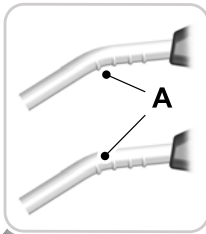

3. Insert the fuel pump nozzle up to the first notch on nozzle A. Keep the fuel pump nozzle resting on the fuel tank filler pipe.

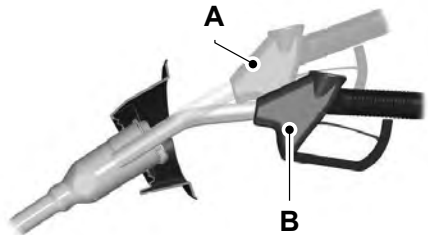

4. Hold the fuel pump nozzle in position B when refueling. Holding the fuel pump nozzle in position A can affect the flow of fuel and shut off the fuel pump nozzle before the fuel tank is full.

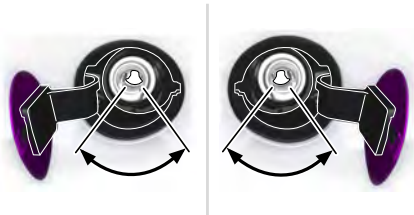

5. Operate the fuel pump nozzle within the area shown.

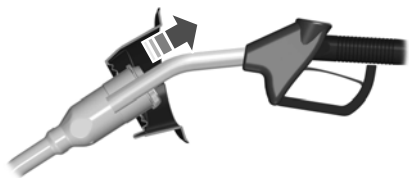

6. When the nozzle shuts off, wait at least 5 seconds, then slightly raise the fuel pump nozzle and slowly remove it.
7. Close the fuel filler door.

Fuel and Refueling

Do not attempt to start the engine if you have filled the fuel tank with incorrect fuel. Incorrect fuel use could cause damage not covered by the vehicle warranty. Have your vehicle immediately checked.

FUEL TANK CAPACITY - 3.5L DURATEC

Variant	Quantity
Vehicles with standard fuel tank.	25.1 gal (95 L)
Vehicles with larger fuel tank.	30.5 gal (115.4 L)

FUEL TANK CAPACITY - 3.5L ECOBOOST™

Variant	Quantity
Vehicles with standard fuel tank.	25.1 gal (95 L)
Vehicles with larger fuel tank.	30.5 gal (115.4 L)

FUEL AND REFUELING – TROUBLESHOOTING

FUEL AND REFUELING – WARNING LAMPS



If it illuminates when you are driving, refuel as soon as possible.

FUEL AND REFUELING – INFORMATION MESSAGES

Message	Action
Fuel Level Low	An early reminder of a low fuel condition. Refill your vehicle.
Check Fuel Fill Inlet	Check to make sure the fuel fill inlet is fully closed.

Catalytic Converter

WHAT IS THE CATALYTIC CONVERTER

The catalytic converter is part of your vehicle's emissions system and filters harmful pollutants from the exhaust gas.

CATALYTIC CONVERTER PRECAUTIONS



WARNING: Do not park, idle or drive your vehicle on dry grass or other dry ground cover. The emission system heats up the engine compartment and exhaust system, creating the risk of fire.



WARNING: The normal operating temperature of the exhaust system is very high. Never work around or attempt to repair any part of the exhaust system until it has cooled. Use special care when working around the catalytic converter. The catalytic converter heats up to a very high temperature after only a short period of engine operation and stays hot after the engine is switched off.



WARNING: Exhaust leaks may result in entry of harmful and potentially lethal fumes into the passenger compartment. If you smell exhaust fumes inside your vehicle, have your vehicle inspected immediately. Do not drive if you smell exhaust fumes.

To avoid damaging the catalytic converter:

- Do not crank the engine for more than 10 seconds at a time.
- Do not run the engine with a spark plug lead disconnected.
- Do not push-start or tow-start your vehicle. Use booster cables. See **Jump Starting the Vehicle** (page 340).

- Use the correct fuel. See **Fuel and Refueling** (page 183).
- Do not switch the ignition off when your vehicle is moving.
- Avoid running out of fuel.
- Have the items listed in scheduled maintenance information performed according to the specified schedule.

Note: Do not make any unauthorized changes to your vehicle or engine. By law, vehicle owners and anyone who manufactures, repairs, or services a fleet of vehicles are not permitted to intentionally remove an emission control device or prevent it from working.

CATALYTIC CONVERTER – TROUBLESHOOTING

CATALYTIC CONVERTER – WARNING LAMPS

Your vehicle has an on-board diagnostics system that monitors the emission control system. If any of the following warning lamps illuminate, this may indicate that the on-board diagnostics system has detected an emission control system malfunction.



Continuing to drive your vehicle may cause reduced power or the engine to stop. Failure to respond to a warning lamp may cause damage that your vehicle Warranty may not cover. Have your vehicle checked as soon as possible.

High Voltage Battery - Battery Electric Vehicle

WHAT IS THE HIGH VOLTAGE BATTERY

The high voltage battery is a highly sophisticated lithium ion battery system, used to store electrified energy to power your vehicle.

HIGH VOLTAGE BATTERY PRECAUTIONS



WARNING: This battery pack should only be serviced by an authorized electric vehicle technician. Improper handling can result in personal injury or death.



WARNING: Keep your hands and clothing clear of the cooling fan.

Your vehicle consists of various high-voltage components and wiring. All of the high-voltage power flows through specific wiring assemblies labeled as such or covered with a solid orange convolute, or orange striped tape, or both. Do not come in contact with these components.

PRESERVING YOUR HIGH VOLTAGE BATTERY

When using the battery at a low state of charge, your vehicle could start disabling accessory features to protect battery life.

If your vehicle reaches a 0% state of charge, recharge your vehicle as soon as possible.

In everyday use it is acceptable to use the full state of charge window, however there are a few best practices we recommend in order to maintain the health and life of your battery.

Overnight Charging

You can increase the longevity and performance of your high voltage battery by using the charge scheduling and departure and comfort settings on your touchscreen or in the FordPass app.

With Charge Scheduling you can improve the high voltage battery's longevity by delaying the start of charging and setting a maximum charging limit. We recommend to set your preferred charging times to start at least 2-3 hours after your typical plug in time. This allows the battery to cool before charging begins. Additionally, setting the maximum charge level to be less than 100% for everyday usage reduces strain on the battery.

You can improve driving range and performance by scheduling departure times and cabin comfort level with the Departure and Comfort features. This not only warm or cool the cabin but also condition the battery to ensure best driving range and performance by the set departure time.

DC Charging

Frequent use of DC charging could result in reducing your battery's efficiency and lifespan. See **What is DC Charging** (page 193).

Storage Temperature

Storing your vehicle in temperatures between 32°F (0°C) and 113°F (45°C) is the most beneficial for the high voltage battery.

Plug in your vehicle at temperatures just above the freezing point or lower to maintain battery performance and maximize driving range.

High Voltage Battery - Battery Electric Vehicle

Storage State of Charge

You can increase the battery life by maintaining your state of charge below 100%. When you park your vehicle for an extended period of 30 days or more, we recommend your battery be at an approximately 50% state of charge. Storing your vehicle's high voltage battery at higher states of charge is less favorable than storing at lower states of charge.

Note: *To achieve this state of charge for storage, you can drive your vehicle down to 50% and set a charge limit for your location. See **Setting the Charging Schedule and Preferences** (page 208).*

RECYCLING AND DISPOSING OF THE HIGH VOLTAGE BATTERY

Please recycle in accordance with local regulations.

HIGH VOLTAGE BATTERY – TROUBLESHOOTING

HIGH VOLTAGE BATTERY – WARNING LAMPS



Illuminates when the powertrain requires service. Have the system checked as soon as possible.

Charging Your Vehicle - Battery Electric Vehicle

WHAT IS AC CHARGING

AC charging is the preferred method of charging. AC charging preserves the health of the high voltage battery for longer high voltage battery life.

WHAT IS DC CHARGING

DC charging allows you to charge the vehicle's high voltage battery in significantly less time than the standard charge method. You can charge on the go before the battery has exhausted all of its power, or when traveling using the trip planner as part of your FordPass App.

For the convenience of DC charging and time, there is a different fee structure depending on the charging station and network you choose.

Note: *Charge times vary depending on outside air temperature, power level, charger type, and location in which you are charging.*

Note: *The vehicle could reduce the maximum DC charging rate as the vehicle ages to maximize the life of the battery, especially if DC charging is often used.*

CHARGING YOUR VEHICLE PRECAUTIONS

 **WARNING:** Do not allow charging equipment to be immersed in water or liquids. Failure to follow this warning could result in fire, serious personal injury or death.

 **WARNING:** Do not attempt to open the charging equipment. Failure to follow this instruction could result in personal injury, death or property damage.

 **WARNING:** Do not use the charging equipment if it is faulty or has been damaged. Failure to follow this instruction could result in personal injury, death or property damage.

 **WARNING:** Install charging equipment in compliance with local regulations. Failure to follow this warning could result in fire, serious personal injury or death.

CHARGING EQUIPMENT

 **WARNING:** Read all warnings on the charging equipment before using for the first time.

 **WARNING:** Read all instructions in this publication before using the charging equipment.

 **WARNING:** Do not use an ungrounded wall outlet. The wall outlet must be in good condition and meet up-to-date local codes. Have a qualified electrician check the wall outlet, if you suspect that it is not properly grounded. Failure to follow this instruction could result in electric shock, personal injury, or death.

 **WARNING:** It is recommended that electrical outlets for use with your charging equipment be installed by a licensed, qualified electrician. Installations must comply with the provisions of all local codes. Failure to follow this warning could result in personal injury or death.

 **WARNING:** Do NOT DROP the control box or coupler.

Charging Your Vehicle - Battery Electric Vehicle

 **WARNING:** Do NOT use if stored outside temperature range specified.

 **WARNING:** Do not attempt to repair the charging equipment. Contact your local dealer for assistance.

 **WARNING:** To reduce the risk of fire, connect only to a circuit provided with 40 amps maximum branch circuit overcurrent protection installed in accordance with NEC and local electrical code.

 **WARNING:** Do not use the charging equipment with an extension cord, surge protector, timer or other adapter. Failure to follow this instruction could result in electric shock or fire.

 **WARNING:** The wall plug must fit firmly into the outlet. If the connection feels loose, worn or the outlet is damaged, have a qualified electrician replace the outlet. Using charging equipment with a worn outlet may cause burns, property damage and increase the risk of electric shock.

 **WARNING:** Fully insert the plug into the wall outlet. Failure to follow this instruction could result in electric shock.

 **WARNING:** Children should be supervised when in the vicinity of the charging equipment while plugged in.

 **WARNING:** Do not put fingers into the electric charge coupler. Failure to follow this instruction could result in electric shock.

 **WARNING:** This equipment has arcing or sparking parts. Do not expose to flammable vapors. Position this equipment at least 18 in (450 mm) above the floor.

 **WARNING:** Do not connect or disconnect any pluggable components of the charging equipment when in use or charging. Failure to follow this instruction can cause damage to the charging equipment.

 **WARNING:** Do not use the charging equipment in temperatures outside of the operation range of -22°F (-30°C) to 122°F (50°C).

 **WARNING:** Store the charging equipment in a clean dry place between the temperatures of -22°F (-30°C) to 185°F (85°C).

 **WARNING:** Do not plug the charging equipment into an electrical outlet that is submerged in water or covered in snow.

 **WARNING:** Do not use charging equipment in severe rain, snow or electrical storm.

 **WARNING:** Do not allow charging equipment to be immersed in water or liquids. Failure to follow this warning could result in fire, electric shock, or serious personal injury or death.

 **WARNING:** When using the charging equipment avoid moisture, water, snow and foreign objects at all times.

Charging Your Vehicle - Battery Electric Vehicle



WARNING: Do not replace the plug on the connector. There are critical safety devices in the plug, and the charging equipment will not operate, if the plug is replaced. Failure to follow this instruction could result in electric shock, personal injury, death, or fire.



WARNING: Charging equipment contains no user modifiable or repairable parts. If the charging equipment plug does not properly fit into the wall outlet, have a qualified electrician install the correct wall outlet. Failure to follow this instruction could result in personal injury or death.



WARNING: High voltage is present in your electric meter housing and power distribution service panel. Contact with high voltage can cause death or serious personal injury.



WARNING: Visually inspect the charging equipment before each use. Do not use the charging equipment if it is damaged.



WARNING: Keep charging equipment inside when not in use. Stow the control box on the hanger or all the charging equipment in the bag after use to prevent damage to the charging equipment and personal injury.

Specification Type	Specification Value
Charger Model	SAE
Voltage	120-240 VAC
Maximum Current	32 amps max continuous
Frequency	60Hz
Power draw when idle	< 2 Watts
Power draw when charging	< 4 Watts
Cable length	Approximately 20 ft (6.1 m)
Weight	8.6 lb (3.9 kg)
Operating temperature	-22°F (-30°C) to 122°F (50°C)
Storage temperature	-22°F (-30°C) to 185°F (85°C)
CCID Environmental	IP67
Ventilation	Not required

Your vehicle comes with a mobile power cord that has a low power connector to use with a 120V plug NEMA 5-15 and a high power connector to use with a 240V plug NEMA 14-50.

Charging Your Vehicle - Battery Electric Vehicle

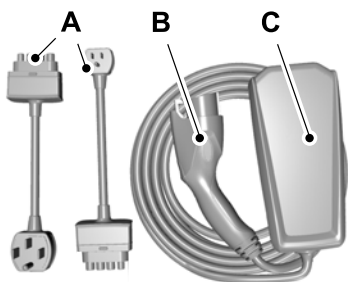

- A Connector.
- B Coupler.
- C Control Box.

The mobile power cord is located under the passenger seat and allows you to charge the vehicle's battery using a standard household outlet.

You must plug the connector into the control box first. Then plug the connector into the household outlet, and then plug the coupler into the vehicle charge port.

The power indicator illuminates blue when the connector is properly inserted into the control box and dedicated wall outlet.

Note: To insert the connector, firmly grasp the connector by the cable or plug and push into the control box until an audible click is heard. Make sure the connector is fully inserted and flush with the control box before inserting it into the outlet. Improper insertion will cause a longer charge session.

Note: Follow the installation instructions provided with the mobile power cord.

Note: We recommend using the supplied plugs and connectors.

Note: If you do not use a dedicated circuit, the circuit breaker could trip or open. If a dedicated circuit is not available, contact a licensed professional electrician regarding the installation of a dedicated outlet.

Note: The mobile power cord does not charge and gives a fault indication, if ground is not present.

Note: Plug the connector for the mobile power cord directly into the wall plug receptacle. Do not plug the mobile power cord into any form of extension cord.

Note: If the wall bracket is not used for mounting the charging equipment, plug the charging equipment into an outlet closer to ground.

Mobile Power Cord Indicator Lights

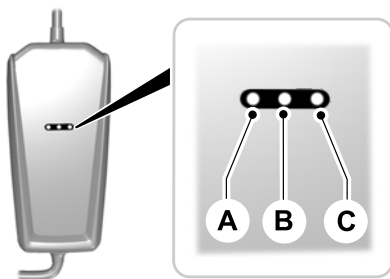

- A Amber Fault Indicator Light.
- B Blue Status Indicator Light.
- C Red Trouble Indicator Light.

Charging Your Vehicle - Battery Electric Vehicle

Mobile Power Cord Fault Indicator Type	Indicator Description
AMBER	The amber fault indicator illuminates to communicate that the charger is rebooting after an error.
BLUE	When plugged into the wall outlet, the blue indicator illuminates to communicate that the charger is ready to use.
RED	The red indicator illuminates when the charger has detected an error. If the red indicator is illuminated, the charger will not deliver power to the vehicle. The error must be corrected before a charging cycle can begin or continue.

Note: *When first plugged into a wall outlet the amber, blue and red indicators will blink once. Then the blue indicator turns on, followed by a blink of the red indicator. After, the blue indicator turns off then back on. This cycle will happen twice if a different connector is used from a previous charge.*

Charging Your Vehicle - Battery Electric Vehicle

AMBER	BLUE	RED	MODE	ACTION
OFF	OFF	OFF	UNPOWERED; The mobile power cord is not powered.	Make sure the outlet is operational, and the circuit breaker is in the ON position or try using another outlet. Ensure the connector is fully inserted into the mobile power cord. Ensure the plug is not severely degraded. If the error persists, contact us.
OFF	PULSING	OFF	CHARGING; The mobile power cord is charging.	No action required.
OFF	ON	OFF	STANDBY; The mobile power cord is powered and ready to charge. At the current time the mobile power cord is not charging the vehicle.	If you expect the mobile power cord to be charging the vehicle, make sure the vehicle coupler is properly inserted into the vehicle. Check and adjust your charging time preferences in the on-screen display. If your vehicle is still not charging, contact us.
ON	ON	ON	REBOOTING; The mobile power cord is recovering after encountering an error.	Wait for the mobile power cord to return to standby. If the mobile power cord cycles for more than 2-3 minutes, unplug the vehicle coupler. Unplug and replug in the connector. If the issue persists, contact us.
ON	PULSING	OFF	CHARGING REDUCED; The mobile power cord is charging at a reduced rate due to overheating.	Make sure the connector and the control box are properly connected. Unplug and replug in the connector. If the mobile power cord is warm or in a hot environment, try charging in a cooler area. Try a different outlet. Try a different connector if you have one available. If the error persists, contact us.

Charging Your Vehicle - Battery Electric Vehicle

AMBER	BLUE	RED	MODE	ACTION
1 FLASH	PULSING	OFF	CHARGING REDUCED, AC PLUG OR WALL OUTLET; The mobile power cord is charging at a reduced rate due to overheating of the connector or the wall outlet.	Make sure the connector and control box are properly connected. Unplug and replug in the connector. If the mobile power cord is warm or in a hot environment, try charging in a cooler area. Try a different outlet. Try a different connector if you have one available. If the error persists, contact us.
ON	OFF	OFF	USER TROUBLESHOOTING; The mobile power cord has encountered a fault that requires troubleshooting.	Make sure the connector and control box are properly connected. Unplug and replug in the connector. If the mobile power cord is warm or in a hot environment, try charging in a cooler area. Try a different outlet. Try a different connector if you have one available. If the error persists, contact us.
OFF	OFF	ON	NON - RECOVERABLE FAULT; There is an internal fault in the mobile power cord that cannot be recovered.	Try a different connector if you have one available. If the error persists, contact us.
OFF	OFF	1 FLASH	NON - RECOVERABLE FAULT; There is an internal fault in the connector that cannot be recovered.	Try using another connector if you have one available. If not, contact us about obtaining a replacement. If your warranty has expired, you can order a replacement from your Ford dealer.
OFF	OFF	PULSING	GROUND LEAKAGE FAULT; Electrical current is leaking through a potentially unsafe path.	Potential shock hazard - immedi- ately turn off circuit breaker for the outlet within home. Discontinue use. Contact us about obtaining a replacement.

Charging Your Vehicle - Battery Electric Vehicle

Note: When plugging into an unfamiliar wall outlet, let the vehicle charge for several minutes before leaving it unattended. The red indicator will illuminate if not charging. The unit will turn off if breaker or infrastructure ground fault circuit interrupter (GFCI) is tripped. You can view vehicle charging status remotely via the Ford Pass App.

Mobile Power Cord Auto-Restart

Auto-restart helps to make sure that your vehicle will be charged and ready for use when needed. A charge could be interrupted if errors are detected. Charging resumes once the error is no longer detected. The red indicator illuminates during an error condition.

The exception to the immediate auto-restart is when the interruption is due to a charger ground fault circuit interrupter (GFCI) event. The charger attempts to restart 15 minutes after a ground fault circuit interrupter (GFCI) event. After the fourth attempt to restart, the charger shuts down and the red indicator stays on.

If the fault persists, do not continue to try to charge your vehicle. Contact your authorized dealer.

MOVING AND STORAGE INSTRUCTIONS

Make sure you wrap the mobile power cord after charging. Store the mobile power cord in the storage bag supplied with the mobile power cord.

When charging is complete, replace the mobile power cord under the passenger seat.

Note: Do not hold the mobile power cord by the power cable. Hold the complete unit and carefully place back in the storage bag.

Note: To remove the connector, firmly grasp the connector by the cable or plug and pull away from the control box.

CARE INSTRUCTIONS

Do not use cleaners or solvents as this could damage your mobile power cord. Do not place stress on the charger cables. If unit overheats, remove the mobile power cord from direct sunlight.

SAFETY FEATURES

The charger includes the following safety features to protect against the risk of electric shock:

- **Service Ground Check:** The charger constantly checks for the presence of a service ground connection. If the service ground ever fails, the charger red indicator turns ON and shuts down power to the vehicle.
- **Thermal Event Sensor:** Charger module senses out-of-ordinary thermal events and decreases the charging current or shuts the unit down if required.
- **Ground fault circuit interrupter (GFCI) Protection:** The charger has a ground fault circuit interrupter (GFCI) reaction system to protect against electric shock. If the charger module detects an output ground fault, it shuts down power to the output cable and illuminates the red indicator.
- **Insulation:** The charger module, connector, cable assembly, and charge coupler are completely insulated. There are no exposed live parts, to protect against electric shock.
- **Unintentional Disconnection:** The charge coupler is designed to minimize unintentional disconnection. A pilot signal wire in the cable and charge coupler eliminates the possibility of electric shock when not connected to a vehicle or if an unintended disconnect occurs during a charge. Disconnection during charging is safe.

Charging Your Vehicle - Battery Electric Vehicle

LOCATING THE CHARGE PORT

The charge port is on the front of the vehicle. To open, press the center right-hand edge of the charge port door and then release.

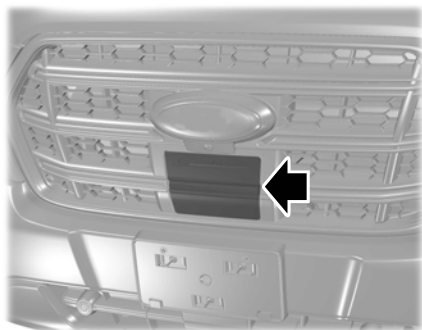

Note: Do not apply excessive force. Forcing the door open or closed damages the charge port.

CHARGE PORT INDICATORS

The charge status indicator is next to the charging port behind the charge port door. It indicates the charge status of the high voltage battery in your vehicle.

Divided into five zones, the charge status indicator displays the state of charge in 20 percent increments.

The charge status indicator displays how far along the charge is:

- When zone A is pulsing, the charge is between 0-20 percent.
- When zone A illuminates, and zone B is pulsing, the charge is between 20-40 percent.

- When zones A and B illuminate and zone C is pulsing, the charge is between 40-60 percent.
- When zones A, B, and C illuminate, and zone D is pulsing, the charge is between 60-80 percent.
- When zones A, B, C, and D illuminate, and zone E is pulsing, the charge is between 80-100 percent.
- When all zones illuminate, the charge is 100 percent.



Note: When charging stops, the charge status indicator shows all the completed zones solidly illuminated up in a blue color for 30 seconds before turning off. For example, if charging stops at 70 percent, then A, B, and C light up solidly to indicate a battery charge level of at least 60 percent but less than 80 percent. Charging stops when complete or when paused due to charge settings or charge station actions.

Note: If the charge status indicator does not light up or pulse after plugging in, please verify that the charge port light setting is On. If you do not wish to have the charge status indicator light up at all while charging, then you can turn it Off. Locate the charge port light under the access menu on your in-vehicle touchscreen.

There are three charge port indicator light colors, which indicate a specific action:

Charging Your Vehicle - Battery Electric Vehicle

White is used as a courtesy light to help with plugging in and to acknowledge actions such as plugging in and unplugging.

Blue is used when the vehicle is plugged in and either charging or waiting to charge.

Amber is used to indicate charge faults.



Note: Charging faults are identified by the color amber on the charge status indicator. Faults can occur within the vehicle charging system or outside the vehicle, such as with the mobile power cord, charge station or electrical supply.

Note: If the system detects a fault in the vehicle charging system at any point in a charge cycle, the entire charge status indicator illuminates solidly in an amber color for 30 seconds and then turns off. If this happens, unplug the charge coupler and then plug it back into the charge port receptacle. If the problem persists, have your vehicle serviced as soon as possible.

Note: If the system detects a fault outside the vehicle, such as with the charge station or mobile power cord, the entire charge status indicator flashes amber continuously for 30 seconds and then turns off. If this happens check the mobile power cord, charge station or electrical supply.

AC CHARGING

CONNECTING THE CHARGER



WARNING: Do not use the charging equipment if it is faulty or has been damaged. Failure to follow this instruction could result in personal injury, fire, electric shock, death or property damage.



Charging Using the Mobile Power Cord

CAUTION: TO REDUCE THE RISK OF FIRE - The plug must be properly grounded. Use a dedicated circuit. If you do not use a dedicated circuit, the circuit breaker could trip or open. If you do not have a dedicated circuit, contact a licensed professional electrician for proper installation.

To charge the high voltage battery:

You must unwrap the mobile power cord completely before charging.

1. Put your vehicle in park (P).

Note: Your vehicle must be in park (P) to charge.

2. Plug the connector into the control box.

Note: To insert the connector, firmly grasp the connector by the cable or plug and push into the control box until an audible click is heard. Make sure the connector is fully inserted and flush with the control box before inserting it into the outlet. Improper insertion will cause a longer charge session or faults.

3. Plug the connector into the wall outlet.
4. Confirm that the mobile power cord indicator lights illuminate.

Charging Your Vehicle - Battery Electric Vehicle



5. Press the center right hand edge of the charge port door and then release to open the door.

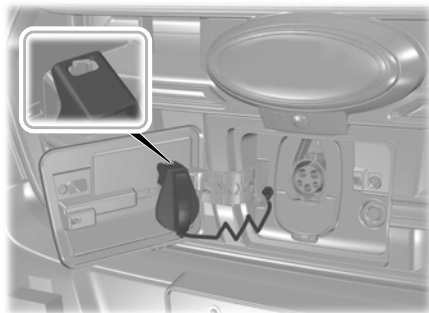

6. Remove the charge port dust cap and hang it on the pin.

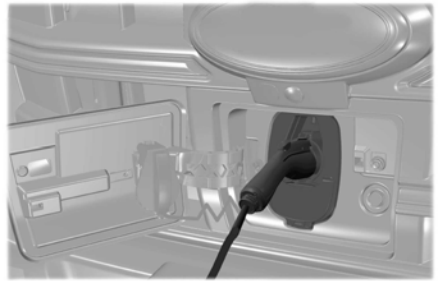

7. Plug the charge coupler into the charge port receptacle on your vehicle.

Note: Make sure the button clicks confirming that you have completely engaged the coupler. When you plug in your vehicle, it starts charging to 100% by default unless scheduled charging has been set up for this location. See **Setting the Charging Schedule and Preferences** (page 208).

Note: Plug the connector into the wall outlet before connecting the charge coupler handle to your vehicle's charge port.

Note: When the handle is properly engaged the light ring illuminates. This indicates the beginning of a normal charge cycle.

Note: There could be a delay in light ring illumination due to vehicle internal communications.

Note: If charging for your vehicle fails, please contact the Customer Relationship Center, or click on Live chat. To ensure superior service, please take note of your serial number when contacting customer support.

For more information, visit www.owner.ford.com.

Charging At a Charge Station

1. Put your vehicle in park (P).

Note: Your vehicle must be in park (P) to charge.

Charging Your Vehicle - Battery Electric Vehicle



2. Press the center right hand edge of the charge port door and then release to open the door.

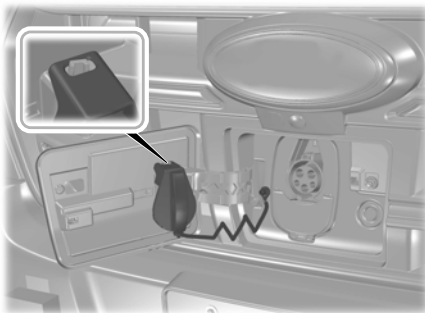

3. Remove the charge port dust cap and hang it on the pin.

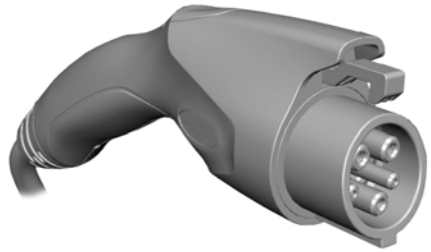

4. Select the appropriate charge station coupler.

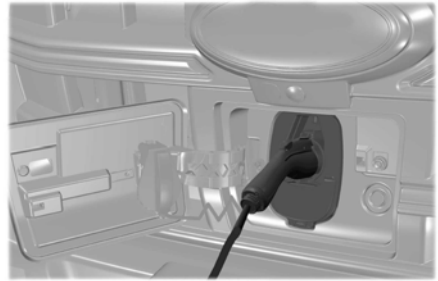

5. Plug the charge coupler handle into the charge port receptacle on your vehicle.

Note: Make sure the button clicks confirming that you have completely engaged the coupler. When you plug in your vehicle, it starts charging to 100% by default unless scheduled charging has been set up for this location. See **Setting the Charging Schedule and Preferences** (page 208).

Note: When the handle is properly engaged the light ring illuminates. This indicates the beginning of a normal charge cycle.

Note: There could be a delay in light ring illumination due to vehicle internal communications.

Charging Your Vehicle - Battery Electric Vehicle

Information about public charge stations is available through the in-vehicle screen as well as the FordPass app with pricing, power levels, and real time availability. Rates for charging varies by power level, provider, location, and time of day.

When charging your vehicle at a BlueOval Charge Network station, use the FordPass app to activate and pay for charging. You can also just plug in to activate charging at Plug & Charge capable stations. If the charging station is not in the BlueOval Charge Network, use the directions on the charge station to activate the charger.

For more information, visit www.owner.ford.com.

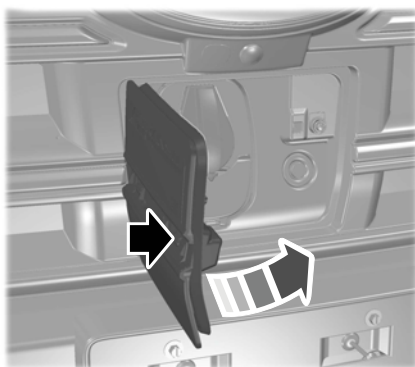

4. Press the center right-hand edge of the charge port door to close.

STOPPING CHARGING



WARNING: To safely discontinue charging at any time, follow the disconnect instructions in stopping charging. Charging will automatically and safely come to a stop. The BLUE STATUS indicator remains ON solid when the coupler is removed.

1. Press the latch on the charge coupler and remove it from the vehicle charge port.
2. Remove the connector plug from the wall outlet.

Note: Do not pull the wall plug from the wall outlet or the connector from the mobile power cord control box, while your vehicle is charging. Doing so could damage the outlet and the cord.

Note: You cannot shift your vehicle out of park (P) until you remove the charge coupler.

3. Reinstall the charge port dust cap.

CHARGE COUPLER MANUAL RELEASE

In the event that your vehicle does not unlock the charge coupler after pressing the unlock button or through the vehicle access menu, you can manually release it.

1. Switch your vehicle off.
2. Open the hood.

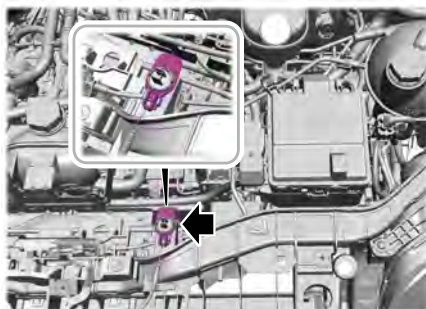

Charging Your Vehicle - Battery Electric Vehicle

3. Locate the yellow manual release ring.

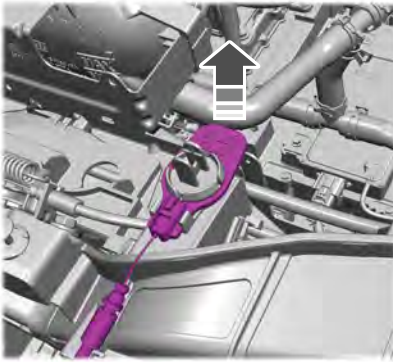

4. Pull the manual release ring upward to detach from grommet.

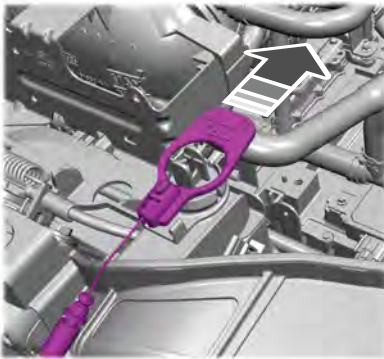

5. Pull the manual release ring in the direction shown.

Note: Only a light effort is required. The pull distance is approximately 2 in (5 cm).

6. Press the latch on the charge coupler and remove it from the vehicle charge port.
7. Reinstall the manual release ring to the grommet.

Note: Make sure the cable is not twisted.

8. Close the hood.

Note: The next time you start your vehicle or plug in to charge, the locking mechanism re-engages and the manual release cable resets.

Note: If the issue persists, have your vehicle checked.

USING YOUR VEHICLE APP AND CHARGING

The vehicle app allows you to do the following:

- Monitor and manage your vehicle's charging, including charge schedules and preferences.
- Locate a charger and activate a charger on the Charging Network.
- Plan a trip and charging options along your route.
- Check charging station plug availability.
- Initiate a charge session automatically at Plug and Charge capable charge stations.
- Control your Connected Charge Station remotely.
- Override charge preferences and starting and stopping charging.

For more information, visit www.owner.ford.com.

DC CHARGING

CONNECTING THE CHARGER



1. Put your vehicle in park (P).

Charging Your Vehicle - Battery Electric Vehicle

Note: Your vehicle must be in park (P) to charge and for the charge status indicator to illuminate.



2. Press the center right hand edge of the charge port door and then release to open the door.

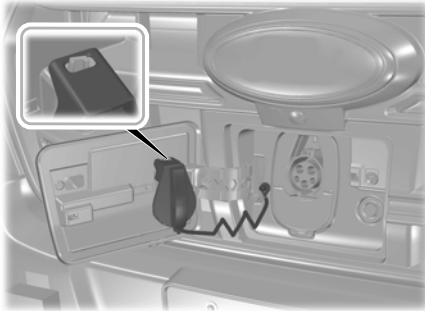

3. Remove the charge port dust cap and hang it on the pin.



4. Open the additional dust cap on the charge port to expose lower connectors.



5. Plug the charge coupler into the charge port receptacle on your vehicle.

Note: Make sure the button clicks confirming that you have completely engaged the coupler. Your vehicle locks to the charge coupler.

Note: When the handle is properly engaged, the light ring illuminates. This indicates the beginning of a normal charge cycle.

Charging Your Vehicle - Battery Electric Vehicle

Note: The vehicle monitors battery health and may take actions including, but not limited to, reducing the DC fast charge rate to protect the battery hardware from damage, and to maintain battery health.

Information about public charge stations is available through the in-vehicle screen as well as the FordPass app with pricing, power levels, and real time availability. Rates for charging varies by power level, provider, location, and time of day.

Note: When charging your vehicle at a public charge station, follow the directions on the charge station.

STOPPING CHARGING



1. Push the coupler unlock button on the light ring.
2. Press the latch on the charge coupler and remove it from the vehicle charge port.

Note: Do not attempt to remove the charge coupler before you unlock it. Do not use any kind of tool to try and remove a locked charge coupler. Doing so can lead to damage to your vehicle and the charge coupler.

Note: You cannot unlock the charge coupler unless the vehicle remote is near the vehicle.

Note: You can also unlock the cord through the vehicle access menu. If the cord still does not unlock, please contact roadside assistance.

Note: You cannot shift your vehicle out of park (P) until you remove the charge coupler.

3. Close the dust cap for the lower connectors.
4. Reinstall the dust cap for the upper connectors.

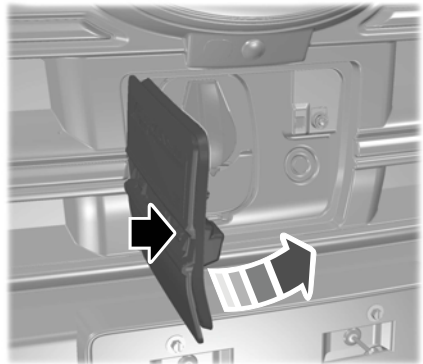

5. Press the center right-hand edge of the charge port door to close.

SETTING THE CHARGING SCHEDULE AND PREFERENCES



You can schedule charging to take advantage of lower-cost electricity rates during off-peak hours if you have signed up for a time of use pricing plan with your utility provider. You can also set an upper charge limit for your battery and a departure time and cabin temperature so your vehicle is ready to go when you are.

Charging Your Vehicle - Battery Electric Vehicle

Scheduled charging can be set up in the on vehicle display or in the FordPass app.

To view your charge settings:

1. Press **Features** on the touchscreen.
2. Press Charge Settings on the touchscreen.

Charge Settings Screen

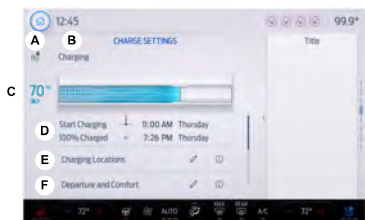

- A Charge status icon.
- B Charge status.
- C High voltage battery state of charge.

- D Charging time information.
- E Charging location preferences.
- F Departure and comfort preferences.

Charge Status Icons

Displays when your vehicle is plugged in.



Not charging due to a fault.



Not currently charging.



Charging.



Waiting to charge based on charge time settings.

Charge Status

Shows the present state of the charging system.

Charge Status	Action
Will charge when plugged in	The vehicle is unplugged and will start charging once plugged in.
Will wait for preferred charge time	The vehicle is unplugged at a location with charge times enabled. Charging is scheduled to start at the time displayed based on your settings. You must plug in prior to the start time shown for the vehicle to begin charging at that time.
Waiting for preferred charge time	The vehicle is plugged in at a location with charge times enabled. Charging will start at the time displayed, which is based on your charge time settings.
Charging stopped	The vehicle is plugged in and charging has been stopped through the FordPass app.
Charging	The vehicle is plugged in and charging.

Charging Your Vehicle - Battery Electric Vehicle

Charge Status	Action
Fast charging	The vehicle is plugged into a DC Fast Charge station and charging.
Charged	The vehicle finished charging to the target state of charge setting.
Charging 12V battery	The vehicle is plugged in and charging the 12V battery.
Cabin conditioning	The vehicle is plugged in and the climate control system is operating according to the departure and comfort settings.
Battery conditioning	The vehicle is plugged in and conditioning the high voltage battery.
Vehicle charge fault	The vehicle is plugged in and there is a fault within the vehicle charging system. Unplug and plug back in. If the fault is still present, contact your authorized EV certified dealer.
Charge station fault	The vehicle is plugged in and a fault has been detected with the charge station or charging cord. Please check the charging cord and the charging station or electrical supply.
Charge station not detected	A charging coupler has been plugged into the vehicle but there is no connection with a charging power source.
Charge station paused	The vehicle is plugged in and charging has been paused at the charge station.

High Voltage Battery State of Charge

Displays the remaining charge percentage with 100% representing the total amount of energy you can get from an external charge.

Charging Time Information

When charging, the start and estimated end times are displayed.

When fast charging, the estimated time is displayed for 80% charge. Above 80% state of charge the estimated time is displayed for 100% charge.

When your vehicle is at a stored charging location and not plugged in, the start and end times display is based on known charging infrastructure.

Note: *Charging time information is estimated. Certain conditions could result in longer charging times. See **Charging Your Vehicle** (page 193).*

Charging Your Vehicle - Battery Electric Vehicle

Charging Locations



Press the edit button to set preferred charge times for a specific charging location.

Your vehicle prioritizes charging based on your preferred time settings. You can set two preferred charging time windows for weekdays and two for weekends. This feature allows you to take advantage of electric utility rate plans that offer lower pricing during certain times of day. Contact your utility company to see what plans are available.

Note: Your vehicle will charge during your preferred time windows. Charging outside these windows only occurs when additional charging time is needed to reach the maximum charge level set for this location by your next departure time.

Note: You can also access this feature using the FordPass app.

Charging Location Setup

Follow these steps to set time and charge level preferences for a charging location.



Press the edit button for charging locations on the charge settings screen.

1. Select an address from the list of recent charge locations. If the previously saved charge locations are not listed, then you must first select add new location. You can also edit settings for previously saved locations.

Note: In order to save a charge location, the vehicle must have previously charged at that location.

2. Confirm that this is the location you want to save with the help of the map view. Edit the location name if desired and set a maximum charge level. Press next.

Note: Depending on the GPS location, the address on the navigation may not precisely match up with your charging location. Confirm on the map that the pin is in the expected location.

Note: Charging will stop when your vehicle reaches the maximum charge level setting.



3. Set preferred charging times for weekday and/or weekend by pressing and dragging along the 24 hour time wheel. You can set up to two blocks of time (charge windows). Press next once you have your desired time settings for weekday and weekend.

Note: Selecting all or none of the 24 hours results in any time of day given equal priority for charging.

4. The summary screen displays your settings for this location. Press save or press the left arrow to go back and change your settings. Whenever your vehicle is at a saved charging location, the charge settings screen displays the location name, and the charging times are based on your preferred time settings for that location plus the next departure time.

Charging Your Vehicle - Battery Electric Vehicle

Note: Reaching your max charge level by your next departure time is always the priority. When charge times are set, charging outside your preferred charging time windows could be necessary in order to finish by your next departure time. In this case, the vehicle will typically begin charging right away after plugging in. Charging will pause when the rest of the charge can be done within the preferred charge windows.

Departure and Comfort



Press the edit button for departure and comfort settings.

Setting departure times allows you to control charging schedules and warm or cool your cabin and the high voltage battery when your vehicle is plugged in, so your vehicle is ready to drive when you are. By setting a departure time, your vehicle can use your charge time settings to minimize your electricity costs but still prioritize finishing charging before your scheduled departure. The calendar view allows you to program two departure times per day for each day of the week.

Note: By using energy from your charging source while plugged in, battery temperature can be managed for best driving performance and less energy will be needed for heating or cooling of the cabin at the start of your drive. This helps maximize your driving range.

Note: You can also access this feature using the FordPass app.

Departure and Comfort Setup

Follow these steps to set departure times and cabin comfort level.

1. Press the edit button for departure and comfort on the charge settings screen.

2. Select a time for each day of the week you want your settings to apply. Select the hour and minutes as well as your desired comfort level. Your selected days/times now display your departure and comfort settings. Press Save to apply your settings. The next departure display on the charge settings screen will update appropriately.

Note: Save your departure settings before selecting additional days/times. The process must be repeated in order to add additional unique departure times and comfort levels.

Note: Cabin conditioning comfort level may vary depending on whether you plug into a normal household outlet or a higher power outlet or charging station. The power available for conditioning is limited to the charging station power available. At low ambient temperatures and low charge power, a small amount of high voltage battery power in addition to the charging power could be used to heat the cabin.

Additional information and settings are displayed on the charge settings screen once charging locations and departure and comfort have been set up.

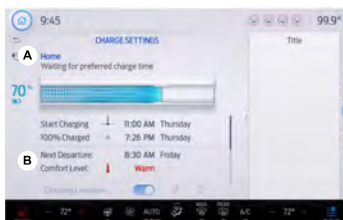

- A Charging location name.
- B Next departure time and cabin temperature.

Charging Your Vehicle - Battery Electric Vehicle

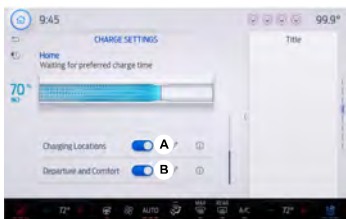

- A On/Off switch for charging locations.
- B On/Off switch for departure and comfort.

Charging Location Name

Displays when your vehicle is at a stored charging location.

Next Departure Time and Cabin Comfort Level

Displays the next departure time and associated cabin comfort setting.

On/Off Switch for Charging Locations

This switch is visible when your vehicle is at a saved charging location. Use this switch to turn your settings off and on for this location only. Switching off for this location does not delete your settings, however, you must switch back on to re-enable them.

Note: *If the charging locations switch is off, the target state of charge returns to 100%.*

On/Off Switch for Departure and Comfort

This switch is visible when you have at least one departure time set. Use this switch to turn all departure times off and on. Switching off departure and comfort does not delete your settings, however, you must switch back on to re-enable them.

USING FORDPASS AND CHARGING

Note: *FordPass may not be available in some countries or fleet vehicles.*

The FordPass app allows you to do the following:

- Monitor and manage your vehicle's charging, including charge schedules and preferences.
- Locate a charger and activate a charger on the BlueOval Charge Network.
- Plan a trip and charging options along your route.
- Check charging station plug availability.
- Initiate a charge session automatically at Plug and Charge capable charge stations.
- Control your Ford Connected Charge Station remotely.
- Override charge preferences and starting and stopping charging.

For more information, visit www.owner.ford.com.

CHARGING YOUR VEHICLE HINTS

AC charging preserves the health of the high voltage battery for longer high voltage battery life.

When AC charging, keep your vehicle plugged in when outside temperatures are very high or low. This enables the system to maintain the high voltage battery for best performance.

Ending the charge at 100% maximizes the driving range for your next trip. Ending the charge at 80% or lower will help to preserve the health of the high voltage battery. Charge rates are significantly slower above 80% state of charge.

Charging Your Vehicle - Battery Electric Vehicle

Note: The system could reduce DC fast charging rate to preserve the battery. This is based on battery temperature, battery state of charge and battery health.

In cold temperatures, you may notice that DC charging takes longer when the outside temperature drops below 50°F (10°C). Shutting off climate control or reducing climate control temperature and fan settings for the first 10 to 15 minutes of DC charging allows the battery to warm up and improve the charging rate.

Note: When the temperature is below freezing, fully turning off cabin heat for the first 10 to 15 minutes of DC charging could significantly improve the charging rate.

Note: When AC charging, keep your vehicle plugged in when the outside temperatures are very high or low. This enables the system to maintain the high voltage battery for best performance. See **Maximizing Your Driving Range** (page 333).

CHARGING YOUR VEHICLE – TROUBLESHOOTING

CHARGING YOUR VEHICLE – WARNING LAMPS



Plugged into charger.

CHARGING YOUR VEHICLE – INFORMATION MESSAGES

Message	Action
Vehicle Plugged In ? Yes No	Your vehicle needs confirmation it is unplugged before allowing a start. You must make sure your vehicle is unplugged and you respond to the message promptly before starting your vehicle.
Plug in to Maintain 12V Battery	Indicates that HV battery can no longer support the 12V battery. Plug In your vehicle to charge the high voltage battery and maintain the 12V battery at a healthy state.
Charge Station Fault See Manual	The vehicle is plugged in and a fault has been detected with the charge station or charging cord. Please check the charging cord and the charging station or electrical supply.

Charging Your Vehicle - Battery Electric Vehicle

CHARGING YOUR VEHICLE – FREQUENTLY ASKED QUESTIONS

Why does my vehicle not charge with the mobile power cord?

- Ensure you properly connect the connector and control box. Unplug the charge coupler from the vehicle and unplug the connector from the wall outlet. Then check the connector to be sure that the connector is connected properly into the mobile power cord control box. If the mobile power cord is warm or in a hot environment, try charging in a cooler area. Try a different outlet or a different connector if you have one available. If the problem persists, contact an authorized EV certified dealer.

Why does my vehicle have a hum or fan noise when charging?

- A hum or a fan noise could be present when charging the high voltage battery. This is a normal operation as your vehicle is keeping the battery cool while charging.

Why does my information display say that the vehicle is charged when it is still pulling power from the charging source?

- In order to keep your battery at the current level, a small amount of power needs to be sourced from the wall to power the vehicle electronics. Once the vehicle is shut down, the vehicle will stop drawing power.

Automatic Transmission

AUTOMATIC TRANSMISSION PRECAUTIONS



WARNING: When your vehicle is stationary, keep the brake pedal fully pressed when shifting gears. Failure to follow this instruction could result in personal injury, death or property damage.



WARNING: Do not apply the brake pedal and accelerator pedal simultaneously. Applying both pedals simultaneously for more than a few seconds limits vehicle performance, which may result in difficulty maintaining speed in traffic and could lead to serious injury.



WARNING: Apply the parking brake, shift into park (P), switch the vehicle off and remove the key or remote control before you leave your vehicle. Failure to follow this instruction could result in personal injury or death.

Note: You may not be able to shift out of park (P) if a fuse is blown.

Note: Your vehicle may not shift out of park (P) unless the key or remote control is inside your vehicle.

Note: The electric parking brake could apply when you power your vehicle on with the selector in park (P).

Note: The electric parking brake could apply if you shift to park (P) without fully pressing the brake pedal.

Note: The electric parking brake could apply if you shift to park (P) on a slope.

Note: Do not manually release the electric parking brake when the selector is in park (P). See **Automatically Releasing the Electric Parking Brake** (page 231).

Note: Your vehicle could shift into park (P) if you attempt to exit your vehicle without the vehicle in park (P). See **How Does Automatic Return to Park (P) Work** (page 222).

Note: A tone could sound when you select park (P).

AUTOMATIC TRANSMISSION POSITIONS

PARK (P)



WARNING: Shift into park (P) only when your vehicle is stationary.

In park (P), power is not transmitted to the driven wheels.

Note: A tone sounds if you attempt to exit your vehicle without the transmission in park (P).

Note: Your vehicle may not shift out of park (P) if the 12V battery has run out of charge.

REVERSE (R)



WARNING: Shift into reverse (R) only when your vehicle is stationary.

In reverse (R) power is transmitted to the driven wheels.

NEUTRAL (N)



WARNING: In neutral (N) your vehicle is free to roll.

In neutral (N), power is not transmitted to the driven wheels.

Automatic Transmission

DRIVE (D)

In drive (D) power is transmitted to the driven wheels.

LOW (L) - 1-SPEED AUTOMATIC TRANSMISSION

In low (L) your vehicle decelerates more noticeably than in drive (D) when the accelerator pedal is released.

Note: We recommend using this mode for driving on hilly or mountainous roads or when towing a trailer. See **Towing a Trailer** (page 319).

MANUAL (M) - 10-SPEED AUTOMATIC TRANSMISSION

In manual (M) you can select a specific gear.

Note: We recommend using this mode for driving on hilly or mountainous roads or when towing a trailer. See **Towing a Trailer** (page 319).

SHIFTING YOUR VEHICLE INTO GEAR - 1-SPEED AUTOMATIC TRANSMISSION



The transmission selector is on the center console.

1. Press and hold the brake pedal.
2. Rotate the outer ring to select a position.

Note: The position illuminates on the transmission selector.

3. Press the low (L) or manual (M) button when your vehicle is in drive (D) to enter or exit mode.

Note: Your vehicle cannot shift from drive (D) to park (P) with a clockwise rotation. Your vehicle cannot shift from park (P) to drive (D) with a counter-clockwise rotation.

AUTOMATIC TRANSMISSION POSITION INDICATORS - 1-SPEED AUTOMATIC TRANSMISSION

The instrument cluster displays the current position.

Automatic Transmission



Note: The position could illuminate on the selector.

AUTOMATIC TRANSMISSION POSITION INDICATORS - 10-SPEED AUTOMATIC TRANSMISSION

The instrument cluster displays the current position.



Note: The position could illuminate on the selector.

SHIFTING YOUR IMMOBILE VEHICLE OUT OF PARK (P) - 1-SPEED AUTOMATIC TRANSMISSION



WARNING: When doing this procedure, you need to take your vehicle out of park (P) which means your vehicle can roll freely. To avoid unwanted vehicle movement, apply the parking brake prior to doing this procedure. Use wheel chocks if appropriate.

Use this procedure to shift your vehicle out of park (P) in the event of an electrical malfunction or emergency.

Note: Your vehicle could shift to park (P) after 30 minutes, or when the vehicle battery charge level is low. Prolonged use of this mode can cause the 12 V battery to run out of charge.

Note: If the battery is out of charge, use an external power source.

Note: This mode could be unavailable if your vehicle is below operating temperature. Warm up your vehicle and attempt the procedure again.

Note: Do not tow your vehicle in this mode. Failure to follow these instructions could result in vehicle damage not covered by the vehicle warranty.

Shifting Your Vehicle Out of Park (P)

1. Apply the parking brake.

Note: If the battery is out of charge, use an external power source to apply the parking brake.

2. Power your vehicle on without your foot on the brake pedal.

3. Fully press and hold the brake pedal.

4. Fully press and hold the accelerator pedal.

5. Shift into neutral (N).

6. Press the low (L) or manual (M) button.

7. Attempt to start your vehicle.

Note: A confirmation message appears when your vehicle enters the mode.

Note: You must complete this procedure within 15 seconds. If your vehicle shifts into park (P) attempt the procedure again.

8. Release accelerator and brake pedals.

9. Release the parking brake.

Note: Your vehicle is free to roll.

10. Switch your vehicle off.

Note: Do not tow your vehicle in this mode.

Returning Your Vehicle to Normal Mode

1. Press the brake pedal.

Automatic Transmission

- Shift into park (P).

SHIFTING YOUR IMMOBILE VEHICLE OUT OF PARK (P) - 10-SPEED AUTOMATIC TRANSMISSION



WARNING: When doing this procedure, you need to take your vehicle out of park (P) which means your vehicle can roll freely. To avoid unwanted vehicle movement, apply the parking brake prior to doing this procedure. Use wheels chocks if appropriate.



WARNING: If the parking brake is fully released, but the brake warning lamp remains illuminated, the brakes may not be working properly. Have your vehicle checked as soon as possible.



WARNING: Do not drive your vehicle until you verify that the stoplamps are working.

Use this procedure to shift your vehicle out of park (P) in the event of an electrical malfunction or emergency.

Shifting Your Vehicle Out of Park

- Apply the parking brake.

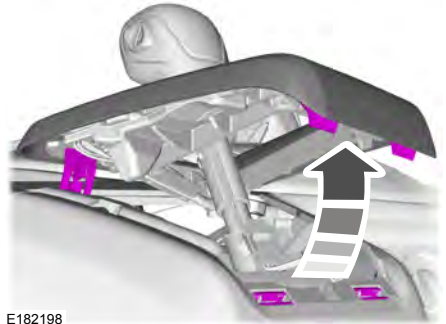

E182198

- Remove the selector cover using using a plastic wedge or pry tool.
- Sit in the drivers seat.
- Press and hold the brake pedal.

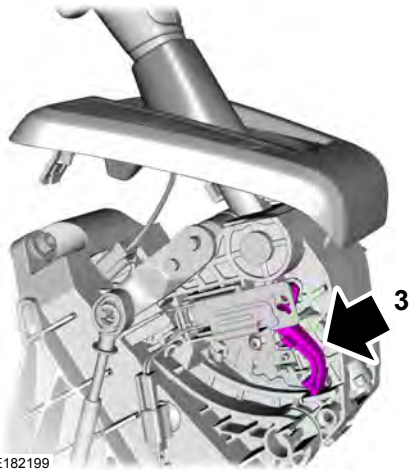

E182199

- Locate the selector override lever.

Automatic Transmission

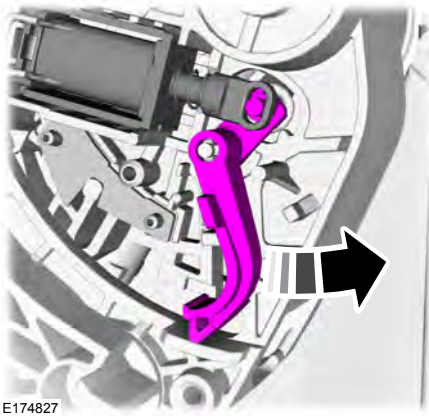

E174827

6. Push the selector override lever toward the rear of your vehicle and hold it there.
7. Shift into neutral (N).
8. Release the selector override lever.
9. Install the selector cover.
10. Release the parking brake.
11. Release the brake pedal.

Note: *Your vehicle is free to roll.*

Returning Your Vehicle to Normal Mode

1. Press the brake pedal.
2. Shift into park (P).

AUTOMATIC TRANSMISSION AUDIBLE WARNINGS-1-SPEED AUTOMATIC TRANSMISSION

Transmission Not in Park (P) Audible Warning

Sounds if you open the driver door before shifting into park (P).

Park Selection Audible Warning

Sounds when you shift into park (P).

AUTOMATIC TRANSMISSION AUDIBLE WARNINGS - 10-SPEED AUTOMATIC TRANSMISSION

Transmission Not in Park (P) Audible Warning

Sounds if any of the following occur:

- You switch your vehicle off before shifting into park (P).
- You open the driver door before shifting into park (P).

USING PROGRESSIVE RANGE SELECTION - 10-SPEED AUTOMATIC TRANSMISSION

Progressive range selection gives you the ability to lock out gears from the automatic shifting range. This could provide you with an improved driving experience by reducing transmission shifts, for example, in slippery conditions or steep slopes.

With the transmission in drive (D), press the minus (-) button to begin to switch the feature on.

Press the minus (-) button again to continue locking out higher gears. Beginning with the highest gear, the instrument cluster will indicate the current gear and highest gear available. For example, press the minus (-) button twice to lock out 10th and 9th gears.

Note: *The instrument cluster will indicate the current gear and highest gear available.*

Press the plus (+) button to unlock gears to allow the transmission to shift to higher gears.

Automatic Transmission

Note: *The transmission automatically shifts within the gear range you select.*

MANUALLY SHIFTING GEARS - 10-SPEED AUTOMATIC TRANSMISSION

SHIFTING USING THE BUTTONS ON THE SELECTOR LEVER

The instrument cluster displays the current gear. The current gear flashes when your vehicle cannot shift into the requested gear. Your vehicle will not shift if the requested gear raises or lowers the engine speed beyond the limit.

Your vehicle could shift when you fully press the accelerator or brake pedal.

Note: *Prolonged driving with high engine speed could cause vehicle damage not covered by the vehicle warranty.*

Note: *Drive modes could affect when the vehicle shifts into the requested gear.*

Manually Shifting Gears in Manual (M)

Use this feature to select a specific gear.

Note: *We recommend using this feature for engine braking, driving on hilly or mountainous roads, or when towing a trailer. See **Towing a Trailer** (page 319).*

Shift to manual (M) to switch the feature on.

- Press the upper (+) button to upshift.
- Press the lower (-) button to downshift.
- Shift to drive (D) to switch the feature off.

TEMPORARY NEUTRAL MODE - 1-SPEED AUTOMATIC TRANSMISSION

HOW DOES TEMPORARY NEUTRAL MODE WORK

Use this mode to keep your vehicle in neutral (N), for a limited time, when you exit your vehicle or switch your vehicle off. For example, if you exit your vehicle before an automatic car wash.

Note: *You do not need to use this mode at an automatic car wash if you shift into neutral (N) and stay in your vehicle with power on.*

Note: *Do not tow your vehicle in this mode.*

Note: *Automatic return to park (P) is delayed when your vehicle is in this mode. See **How Does Automatic Return to Park (P) Work** (page 222).*

TEMPORARY NEUTRAL MODE LIMITATIONS

This mode could be unavailable if your 12 V battery charge level is low. Connect an external power source and attempt the procedure again.

Your vehicle could shift to park (P) after 30 minutes, or when the vehicle battery charge level is low. Prolonged use of this mode can cause the 12 V battery to run out of charge.

This mode could be unavailable if your vehicle is below operating temperature. Warm up your vehicle and attempt the procedure again.

Do not tow your vehicle in this mode. Failure to follow these instructions could result in vehicle damage not covered by the vehicle warranty.

Automatic Transmission

ENTERING TEMPORARY NEUTRAL MODE

1. Bring your vehicle to a complete stop.
2. Press and hold the brake pedal.
3. Power your vehicle on.
4. Shift into neutral (N).

Note: *An instructional message appears.*

5. Press the low (L) or manual (M) button.

Note: *A confirmation message appears when your vehicle enters the mode.*

6. Release the brake pedal.

Note: *Your vehicle is free to roll.*

7. Switch your vehicle off.

Note: *Do not tow your vehicle in this mode.*

Note: *The neutral (N) indicator on the transmission selector may flash in this mode.*

EXITING TEMPORARY NEUTRAL MODE

1. Press the brake pedal.
2. Shift into park (P), or power your vehicle on and shift into drive (D) or reverse (R).

AUTOMATIC RETURN TO PARK (P) - 1-SPEED AUTOMATIC TRANSMISSION

HOW DOES AUTOMATIC RETURN TO PARK (P) WORK

Your vehicle shifts into park (P) when your vehicle is stationary and any of the following occur:

- You switch the vehicle off.
- You open the driver door with the driver seatbelt unfastened.
- You unfasten the driver seatbelt when the driver door is open.

Note: *Do not use automatic return to park (P) when your vehicle is moving, except in an emergency. See **Stopping the Engine When Your Vehicle is Moving** (page 175). See **Powering Off** (page 180).*

AUTOMATIC RETURN TO PARK (P) LIMITATIONS

Automatic return to park could not work if any of the following occur:

- The driver seat sensor is malfunctioning.
- The driver seatbelt sensor is malfunctioning.

See an authorized dealer if any of the following occur:

- Seatbelt indicator illuminates or tone sounds with the driver seatbelt fastened.
- Transmission not in park message appears after you shift out of park (P).

Automatic Transmission

AUTOMATIC TRANSMISSION – TROUBLESHOOTING

AUTOMATIC TRANSMISSION – INFORMATION MESSAGES

Message	Details
Transmission Service Required	The system has detected a fault that requires service. Have your vehicle checked as soon as possible.
Transmission Not in Park	Displays as a reminder to shift into park (P).
Press Brake to Unlock Gearshift Lever	Press the brake pedal to unlock the transmission.

All-Wheel Drive

HOW DOES ALL-WHEEL DRIVE WORK

The all-wheel drive system is designed to continuously monitor and adjust power delivery to the front and rear wheels to optimize both traction and handling.

There is further information on driving in unique driving conditions. See **Driving Hints** (page 329).

ALL-WHEEL DRIVE PRECAUTIONS



WARNING: Do not become overconfident in the ability of all-wheel drive vehicles. Although an all-wheel drive vehicle may accelerate better than a two-wheel drive vehicle in low traction situations, it won't stop any faster than two-wheel drive vehicles. Always drive at a safe speed.

- Drive slower in strong crosswinds that can affect the normal steering characteristics of your vehicle.
- When driving your vehicle on surfaces made slippery by loose sand, water, gravel, snow or ice, proceed with care.

ALL-WHEEL DRIVE LIMITATIONS

The all-wheel drive system is not intended for use with mismatched tires.

Different tire sizes between the front and rear axles can cause system damage.

ALL-WHEEL DRIVE – TROUBLESHOOTING

ALL-WHEEL DRIVE – INFORMATION MESSAGES

Message	Action
AWD Temporarily Disabled	The all-wheel drive system temporarily turns off to protect itself from overheating.
AWD Off	The all-wheel drive system is not operating properly. If the warning stays on or continues to come on, contact an authorized dealer.
AWD Restored	The all-wheel drive system will resume normal function.

Brakes

BRAKE PRECAUTIONS

Wet brakes result in reduced braking efficiency. Gently press the brake pedal a few times when leaving a car wash or driving from standing water to dry the brakes.

Note: *Depending on applicable laws and regulations in the country for which your vehicle was originally built, your brake lamps may flash during heavy braking. Following this, your hazard lights may also flash when your vehicle comes to a stop.*

ANTI-LOCK BRAKING SYSTEM

ANTI-LOCK BRAKING SYSTEM LIMITATIONS

The anti-lock braking system does not eliminate the risk of crash when:

- You drive too closely to the vehicle in front of you.
- Your vehicle is hydroplaning.
- You take corners too fast.
- The road surface is poor.

Note: *If the system activates, the brake pedal could pulse and travel further. Maintain pressure on the brake pedal.*

BRAKE OVER ACCELERATOR

In the event the accelerator pedal becomes stuck or entrapped, apply steady and firm pressure to the brake pedal to slow the vehicle and reduce engine power. If you experience this condition, apply the brakes and bring your vehicle to a safe stop. Move the transmission to park (P), switch the engine off and apply the parking brake. Inspect the accelerator pedal for any interference. If none are found and the condition persists, have your vehicle towed to the nearest authorized dealer.

LOCATING THE BRAKE FLUID RESERVOIR

See **Under Hood Overview** (page 367).

CHECKING THE BRAKE FLUID



WARNING: Do not use any fluid other than the recommended brake fluid as this will reduce brake efficiency. Use of incorrect fluid could result in the loss of vehicle control, serious personal injury or death.



WARNING: Only use brake fluid from a sealed container. Contamination with dirt, water, petroleum products or other materials may result in brake system damage or failure. Failure to adhere to this warning could result in the loss of vehicle control, serious personal injury or death.



WARNING: Do not allow the fluid to touch your skin or eyes. If this happens, rinse the affected areas immediately with plenty of water and contact your physician.



WARNING: The brake system could be affected if the brake fluid level is below the **MIN** mark or above the **MAX** mark on the brake fluid reservoir.

1. Park your vehicle on a level surface.

Brakes



2. Look at the brake fluid reservoir to see where the brake fluid level is relative to the **MIN** and the **MAX** marks on the reservoir.

Note: To avoid fluid contamination, the reservoir cap must remain in place and fully tight, unless you are adding fluid.

Only use fluid that meets our specifications. See **Brakes** (page 225).

BRAKE FLUID SPECIFICATION

See **Brake Fluid Specification** (page 226).

BRAKES – TROUBLESHOOTING

BRAKES – WARNING LAMPS



WARNING: Driving your vehicle with the warning lamp on is dangerous. A significant decrease in braking performance may occur. It may take you longer to stop your vehicle. Have your vehicle checked as soon as possible. Driving extended distances with the parking brake engaged can cause brake failure and the risk of personal injury.



If the ABS indicator illuminates when you are driving, this indicates a malfunction. Your vehicle continues to have normal braking without the anti-lock braking system function. See an authorized dealer.

It also momentarily illuminates when you switch the ignition on to confirm the lamp is functional. If it does not illuminate when you switch the ignition on, or begins to flash at any time, have the system checked by an authorized dealer.

BRAKE



The brake indicator momentarily illuminates when you switch the ignition on to confirm the lamp is functional. It may also illuminate when you apply the parking brake and the ignition is on. If it illuminates when your vehicle is moving, make sure the parking brake is disengaged. If the parking brake is disengaged, this indicates low brake fluid level or a brake system fault. See an authorized dealer.

Note: Lamps may vary depending on region.

BRAKES – FREQUENTLY ASKED QUESTIONS

Is it normal for my brakes to make noise?

Occasional brake noise is normal. If a metal-to-metal, continuous grinding, or continuous squeal sound is present, the brake lining could be worn-out. Have your vehicle checked as soon as possible.

There is an electrical motor sound after I press the brake pedal or activate the electric parking brake. Is this normal?

Yes, those sounds are from the brake system operating.

Note: *Brake dust could accumulate on the wheels, even under normal driving conditions. Some dust is normal as the brakes wear and does not contribute to brake noise. See **Cleaning Wheels** (page 403).*

Parking Brake - Vehicles With: Conventional Mechanical Parking Brake

APPLYING THE PARKING BRAKE



WARNING: Always fully apply the parking brake and make sure you shift into park (P). Failure to follow this instruction could result in personal injury or death.

1. Firmly press the brake pedal.
2. Pull the parking lever upward to its fullest extent.

Note: Do not press the release button while pulling the parking brake lever upward.

Note: If you park your vehicle on a hill and facing uphill, shift into park (P) and turn the steering wheel away from the curb.

Note: If you park your vehicle on a hill and facing downhill, shift into park (P) and turn the steering wheel toward the curb.

RELEASING THE PARKING BRAKE

1. Firmly press the brake pedal.
2. Slightly pull the parking brake lever upward.
3. Press the release button and push the parking brake lever downward.

PARKING BRAKE AUDIBLE WARNING

Sounds when the parking brake is on and your vehicle is moving.

If the warning tone continues after you have released the parking brake, this indicates a malfunction. Have your vehicle checked as soon as possible.

PARKING BRAKE – TROUBLESHOOTING

PARKING BRAKE – WARNING LAMPS



WARNING: If you drive extended distances with the parking brake applied, you could cause damage to the brake system.



It illuminates when you engage the parking brake and the ignition is on.

If it illuminates when your vehicle is moving, make sure the parking brake is disengaged. If the parking brake is disengaged, this indicates low brake fluid level or a brake system fault. Have your vehicle checked as soon as possible.

PARKING BRAKE – INFORMATION MESSAGES

Message	Description
Park Brake Engaged	You have not released the parking brake and your vehicle reaches 3 mph (5 km/h). If the message continues to appear after you have released the parking brake, have your vehicle checked as soon as possible.

Parking Brake - Vehicles With: Push Down Parking Brake

APPLYING THE PARKING BRAKE



WARNING: Always fully apply the parking brake and make sure you shift into park (P). Failure to follow this instruction could result in personal injury or death.

1. Firmly press the brake pedal.
2. Pull the parking lever upward to its fullest extent.

Note: Do not press the release button while pulling the parking brake lever upward.

Note: If you park your vehicle on a hill and facing uphill, shift into park (P) and turn the steering wheel away from the curb.

Note: If you park your vehicle on a hill and facing downhill, shift into park (P) and turn the steering wheel toward the curb.

RELEASING THE PARKING BRAKE

1. Firmly press the brake pedal.
2. Pull the parking brake lever upward to its fullest extent.
3. Press the release button and push the parking brake lever downward.

PUSHING THE PARKING BRAKE LEVER DOWN



E172225

If required, you can lower the parking brake lever to the fully down position, for example to swivel the seat. Push the parking brake lever downward without pressing the release button. The parking brake remains applied until you release it.

PARKING BRAKE AUDIBLE WARNING

Sounds when the parking brake is on and your vehicle is moving.

If the warning tone continues after you have released the parking brake, this indicates a malfunction. Have your vehicle checked as soon as possible.

Parking Brake - Vehicles With: Push Down Parking Brake

PARKING BRAKE – TROUBLESHOOTING

PARKING BRAKE – WARNING LAMPS



WARNING: If you drive extended distances with the parking brake applied, you could cause damage to the brake

system.



It illuminates when you engage the parking brake and the ignition is on.

If it illuminates when your vehicle is moving, make sure the parking brake is disengaged. If the parking brake is disengaged, this indicates low brake fluid level or a brake system fault. Have your vehicle checked as soon as possible.

PARKING BRAKE – INFORMATION MESSAGES

Message	Description
Park Brake Engaged	You have not released the parking brake and your vehicle reaches 3 mph (5 km/h). If the message continues to appear after you have released the parking brake, have your vehicle checked as soon as possible.

Electric Parking Brake

WHAT IS THE ELECTRIC PARKING BRAKE

The electric parking brake is used to hold your vehicle on slopes and flat roads.

APPLYING THE ELECTRIC PARKING BRAKE



WARNING: Always fully apply the parking brake and make sure you shift into park (P). Failure to follow this instruction could result in personal injury or death.



WARNING: If you drive extended distances with the parking brake applied, you could cause damage to the brake system.



The switch is next to the steering wheel on the lower part of the instrument panel.

1. Pull the switch up.

The red warning lamp flashes during operation and illuminates when the parking brake is applied.

Note: You can apply the electric parking brake when the ignition is off.

Note: The electric parking brake could apply when you shift into park (P). See **Park (P)** (page 216).

APPLYING THE ELECTRIC PARKING BRAKE IN AN EMERGENCY

You can use the electric parking brake to slow or stop your vehicle in an emergency.

Pull the switch up and hold it.

The red warning lamp illuminates, a tone sounds and the stoplamps turn on when you use the electric parking brake in an emergency.

The electric parking brake continues to slow your vehicle down unless you release the switch.

Note: Do not apply the electric parking brake when your vehicle is moving, except in an emergency. If you repeatedly use the electric parking brake to slow or stop your vehicle, you could cause damage to the brake system.

MANUALLY RELEASING THE ELECTRIC PARKING BRAKE

1. Switch the ignition on.
2. Press and hold the brake pedal.
3. Push the switch down.

The red warning lamp turns off.

Pulling Away When Towing a Trailer Uphill

1. Press and hold the brake pedal.
2. Pull the switch upward and hold it.
3. Shift into gear.
4. Press the accelerator pedal until engine has developed sufficient torque to prevent your vehicle from rolling down the hill.
5. Release the switch and pull away in a normal manner.

AUTOMATICALLY RELEASING THE ELECTRIC PARKING BRAKE

1. Close the driver door.
2. Fasten the driver seatbelt.
3. Shift into gear.

Electric Parking Brake

4. Press the accelerator pedal and pull away in a normal manner.

ELECTRIC PARKING BRAKE AUDIBLE WARNING

Sounds when the parking brake is on and your vehicle is moving. If the warning tone continues after you have released the parking brake, this indicates a malfunction. Have your vehicle checked as soon as possible.

RELEASING THE ELECTRIC PARKING BRAKE IF THE VEHICLE BATTERY HAS RUN OUT OF CHARGE



WARNING: The electric parking brake does not operate if the vehicle battery has run out of charge.

Connect a booster battery to the vehicle battery to release the electric parking brake if the vehicle battery has run out of charge. See **Jump Starting the Vehicle** (page 340).

ELECTRIC PARKING BRAKE – TROUBLESHOOTING

ELECTRIC PARKING BRAKE – WARNING LAMPS

BRAKE The red warning lamp illuminates when the electronic parking brake is applied or for a few seconds on start up.



If it remains illuminated or flashes when the electronic parking brake is not applied, it indicates a malfunction. Have your vehicle checked as soon as possible.

ELECTRIC PARKING BRAKE – INFORMATION MESSAGES

Message	Details
Park Brake Malfunction Service Now	The electric parking brake has malfunctioned. Have your vehicle checked as soon as possible.
Park Brake Not Released	The electric parking brake has not released. Manually release the electric parking brake. If the message continues to appear, have your vehicle checked as soon as possible.
Park Brake Not Applied	The electric parking brake has not applied. Apply the electric parking brake. If the message continues to appear, have your vehicle checked as soon as possible.
Park Brake Use Switch to Release	The electric parking brake has not automatically released. Manually release the electric parking brake.
To Release: Press Brake and Switch	You have not pressed the brake pedal. Press the brake pedal to release the parking brake.

Electric Parking Brake

Message	Details
Park Brake Limited Function Service Required	The electric parking brake has malfunctioned. Have your vehicle checked as soon as possible.
Park Brake Maintenance Mode	The electric parking brake system has been put into a special mode that is used to allow service of the brakes. Have your vehicle checked as soon as possible.
Park Brake System Overheated	The electric parking brake has overheated. Wait for the electric parking brake to cool down.
Park Brake Released	The electric parking brake is released.
Release Park Brake	The electric parking brake has not released. Manually release the electric parking brake. If the message continues to appear, have your vehicle checked as soon as possible.
Park Brake Applied	The electric parking brake is applied.

Reverse Brake Assist

WHAT IS REVERSE BRAKE ASSIST

Reverse brake assist is designed to reduce impact damage or assist in avoiding a collision while in reverse (R). Using sensors on the rear of the vehicle, it can detect a possible collision and apply the brakes. If full braking occurs, the system attempts to stop the vehicle a safe distance from the obstacle.

HOW DOES REVERSE BRAKE ASSIST WORK

Reverse brake assist functions when in reverse (R) and traveling at a speed of 1–7 mph (2–12 km/h).

If the system detects an obstacle behind your vehicle, it provides a warning through the rear parking aid or cross traffic alert system.

REVERSE BRAKE ASSIST PRECAUTIONS

 **WARNING:** You are responsible for controlling your vehicle at all times. The system is designed to be an aid and does not relieve you of your responsibility to drive with due care and attention. Failure to follow this instruction could result in the loss of control of your vehicle, personal injury or death.

 **WARNING:** To help avoid personal injury, always use caution when in reverse (R) and when using the sensing system.

 **WARNING:** The system may not operate properly during severe weather conditions, for example snow, ice, heavy rain and spray. Always drive with due care and attention. Failure to take care may result in a crash.

 **WARNING:** Traffic control systems, fluorescent lamps, inclement weather, air brakes, external motors and fans may affect the correct operation of the sensing system. This may cause reduced performance or false alerts.

 **WARNING:** Some situations and objects prevent hazard detection. For example low or direct sunlight, inclement weather, unconventional vehicle types, and pedestrians. Apply the brakes when necessary. Failure to follow this instruction could result in the loss of control of your vehicle, personal injury or death.

 **WARNING:** Do not use the system with accessories that extend beyond the front or rear of your vehicle, for example a trailer hitch or bike rack. The system is not able to make corrections for the additional length of the accessories.

The system only applies the brakes for a short period of time when an event occurs. Act as soon as you notice the brakes apply to remain in control of the vehicle. If you do not intervene the vehicle may start to move again.

Note: *Certain add-on devices around the bumper or fascia may create false alerts. For example, large trailer hitches, bicycle or surfboard racks, license plate brackets, bumper covers or any other device that may block the normal detection zone of the system. Remove the add-on device to prevent false alerts.*

Reverse Brake Assist

Note: The system does not react to small or moving objects, particularly those close to the ground.

Note: The system does not operate during hard acceleration or steering.

Note: If your vehicle sustains damage to the bumper or fascia leaving it misaligned or bent, it could alter the sensing zone causing inaccurate measurement of obstacles or false alerts.

Note: Vehicle loading and suspension changes can impact the angle of the sensors and may change the normal detection zone of the system resulting in inaccurate measurement of obstacles or false alerts.

Note: When you connect a trailer, the system may detect the trailer and provide an alert, or the system turns off. If the system does not turn off, manually switch the system off after you connect the trailer.

Note: You may experience reduced system performance on road surfaces that limit deceleration. For example, roads with ice, loose gravel, mud or sand.

SWITCHING REVERSE BRAKE ASSIST ON AND OFF

1. Press **Settings** on the touchscreen.
2. Press **Vehicle**.

3. Switch **Reverse Brake Assist** on or off.

Note: The system is unavailable when the rear parking aid, cross traffic alert or traction control is off.

Note: If your vehicle is not equipped with cross traffic alert the reverse braking assist relies on input from the rear parking aid and rear camera sensors.

Note: The default setting is on in some regions.

OVERRIDING REVERSE BRAKE ASSIST

There could be instances when unexpected or unwanted braking occurs. Firmly pressing the accelerator pedal or switching the feature off overrides the system.

REVERSE BRAKE ASSIST INDICATORS

If the system determines that a collision with an obstacle may occur, full braking may apply.



A message and warning indicator appear when the system applies the brakes.

Reverse Brake Assist

REVERSE BRAKE ASSIST – TROUBLESHOOTING

REVERSE BRAKE ASSIST – INFORMATION MESSAGES

Message	Description
Reverse Brake Assist	Displays when the system applies the brakes and remains on for a few seconds.
Reverse Brake Assist Not Available See Manual	Make sure that all doors, liftgate or tailgate and hood are closed. Drive the vehicle on a straight road for a short period. Make sure the parking aids and cross traffic alert systems are on. If the message remains on, have the system checked as soon as possible.
Reverse Brake Assist Fault	Displays when a system error has occurred. Have your vehicle checked as soon as possible.
Reverse Brake Assist Off	Displays when reverse brake assist is off.

Reverse Brake Assist

REVERSE BRAKE ASSIST – FREQUENTLY ASKED QUESTIONS

Why is reverse brake assist unavailable?

- Make sure the reverse brake assist is on. See **Switching Reverse Brake Assist On and Off** (page 235).
- Make sure that all doors, liftgate or tailgate and hood are closed. Drive the vehicle on a straight road for a short period. If the message remains, have the system checked.
- If your vehicle has the cross traffic alert system, make sure it is on. See **Switching Cross Traffic Alert On and Off** (page 298).
- Make sure the rear parking aid system is on. See **Parking Aids** (page 246).
- Make sure the traction control is on. See **Switching Stability Control On and Off** (page 243).
- Your vehicle may have sustained a rear end impact. Have the sensors checked for proper coverage and operation.
- An anti-lock brake, traction control or stability control event may have occurred. Reverse brake assist resumes operation when the event is complete.
- Make sure the rear view camera and 360 degree camera are not dirty or obstructed. If dirty, clean the camera. If the message still appears after cleaning the camera, wait a short time for the message to clear. If the message does not clear, have the system checked.

- Make sure the cross traffic alert, rear parking aid and side parking aid sensors are not blocked or faulty. See **Locating the Cross Traffic Alert Sensors** (page 298). See **Locating the Rear Parking Aid Sensors** (page 247). See **Locating the Side Parking Aid Sensors** (page 249).
- You recently had your vehicle serviced, or the battery disconnected. Drive your vehicle a short distance to resume system operation.
- Reverse brake assist does not function when you connect a trailer. Operation resumes when you disconnect the trailer.

Note: *If the answers to why the system is unavailable do not assist in returning reverse brake assist to available, have the system checked as soon as possible.*

Hill Start Assist

WHAT IS HILL START ASSIST

Hill Start Assist applies the brakes to hold your vehicle after you bring it to a stop on a slope. This makes it easier for you to pull away without using the parking brake.

HOW DOES HILL START ASSIST WORK

When the system activates, your vehicle remains stationary for a few seconds after you release the brake pedal. This gives you time to move your foot from the brake pedal to the accelerator pedal. The brakes release when you apply the accelerator pedal and the vehicle begins to move forward, or the system exceeds the time allowed for automatically applying the brakes.

The system activates when your vehicle is in any forward gear and facing uphill, or when your vehicle is in reverse (R) and facing downhill.

HILL START ASSIST PRECAUTIONS



WARNING: The system does not replace the parking brake. When you leave your vehicle, always apply the parking brake.



WARNING: You must remain in your vehicle when the system turns on. At all times you are responsible for controlling your vehicle, supervising the system, and intervening if required. Failure to follow this instruction could result in the loss of control of your vehicle, personal injury or death.



WARNING: The system turns off if there is a malfunction.

HILL START ASSIST – TROUBLESHOOTING

HILL START ASSIST – INFORMATION MESSAGES

Message	Details
Hill Start Assist Not Available	Displays when system is not available. Have your vehicle checked as soon as possible.

Auto Hold

HOW DOES AUTO HOLD WORK

Auto hold applies the brakes to hold your vehicle after you bring the vehicle to a stop. This can help when waiting on a hill or in traffic.

SWITCHING AUTO HOLD ON AND OFF



WARNING: The system does not replace the parking brake. When you leave your vehicle, always apply the parking brake.



WARNING: You must remain in your vehicle when the system turns on. At all times you are responsible for controlling your vehicle, supervising the system, and intervening if required. Failure to follow this instruction could result in the loss of control of your vehicle, personal injury or death.



WARNING: The system will turn off if a malfunction is apparent. Failure to take care may result in the loss of control of your vehicle, serious personal injury or death.

Close the driver door and fasten your seatbelt before you switch the system on.



Press the button on the instrument panel.

Note: The system remembers the last setting when you start your vehicle.

Note: Make sure you switch the system off before using an automatic car wash.

USING AUTO HOLD

1. Bring your vehicle to a complete stop. The auto hold active indicator illuminates in the information display.
2. Release the brake pedal. The system holds your vehicle at a standstill. The auto hold active indicator remains illuminated in the information display.
3. Apply the accelerator and drive off in a normal manner. The system releases the brakes and the auto hold active indicator switches off.

Note: The system only activates if you apply enough brake pressure on the brake pedal to bring the vehicle to a standstill.

Note: Under certain conditions, the system could apply the electric parking brake. The brake system warning lamp illuminates. The electric parking brake releases when you press the accelerator pedal. See **Automatically Releasing the Electric Parking Brake** (page 231).

Note: The system switches off if you shift into reverse (R) or neutral (N) while pressing the brake pedal.

There could be actions that can cause the auto hold system not to work when the following occur:

- When you use active park assist.
- Your vehicle is in stay in neutral mode.
- The driver door is open.
- You shift into reverse (R) or neutral (N) before the system is active.

AUTO HOLD INDICATORS



Illuminates when the system is active. Your vehicle remains stationary after you release the brake pedal.

Auto Hold



Illuminates when the system is on but unavailable to hold your vehicle at a standstill.

Traction Control

WHAT IS TRACTION CONTROL

The traction control system helps to avoid drive wheel spin and loss of traction.

HOW DOES TRACTION CONTROL WORK

If your vehicle begins to slide, the system applies the brakes to individual wheels and, when needed, reduces power at the same time. If the wheels spin when accelerating on slippery or loose surfaces, the system reduces power in order to increase traction.

SWITCHING TRACTION CONTROL ON AND OFF - VEHICLES WITH: SYNC 3 LITE, VEHICLES WITHOUT: SYNC



WARNING: Operating your vehicle with the traction control disabled could lead to an increased risk of loss of vehicle control, vehicle rollover, personal injury and death.

The traction control system turns on each time you switch the power on.

If your vehicle is stuck in mud or snow, switching traction control off may be beneficial as this allows the wheels to spin.



Press the traction control button on the instrument panel to switch the system off or on.

Note: When you switch traction control off, stability control remains partially active.

Note: Your vehicle could have MyKey restrictions regarding this feature. See **What Is MyKey** (page 79).

SWITCHING TRACTION CONTROL ON AND OFF - VEHICLES WITH: SYNC 4



WARNING: Operating your vehicle with the traction control disabled could lead to an increased risk of loss of vehicle control, vehicle rollover, personal injury and death.

The traction control system turns on each time you switch the power on.

If your vehicle is stuck in mud or snow, switching traction control off may be beneficial as this allows the wheels to spin.

1. Press the menu button on the steering wheel to enter the instrument cluster display main menu.
2. Using the information display controls on the steering wheel, select **Driver Assist**.
3. Switch **Traction Control** on or off.

Note: When you switch traction control off, stability control remains partially active.

Note: Your vehicle could have MyKey restrictions regarding this feature. See **What Is MyKey** (page 79).

TRACTION CONTROL INDICATOR



Flashes during operation.

If it does not illuminate when you switch the ignition on, or remains on when the engine is running, this indicates a malfunction. Have your vehicle checked as soon as possible.

Traction Control

TRACTION CONTROL – TROUBLESHOOTING

TRACTION CONTROL – WARNING LAMPS



It illuminates when you switch the system off.

TRACTION CONTROL – INFORMATION MESSAGES

Message	Details
Traction Control Off	The status of the traction control system after you switched it off.
Traction Control On	The status of the traction control system after you switched it on.

Stability Control

WHAT IS STABILITY CONTROL

The system is designed to support stability when your vehicle starts to slide away from your intended path.

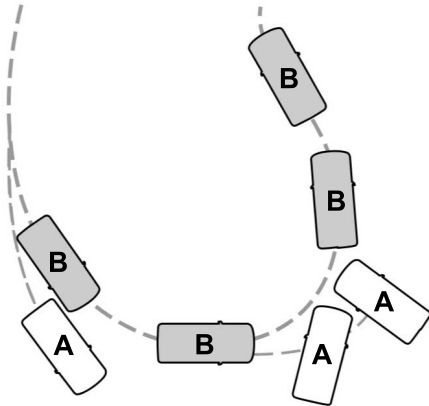

- A Without stability control.
- B With stability control.

HOW DOES STABILITY CONTROL WORK

WARNING: Vehicle modifications involving braking system, aftermarket roof racks, suspension, steering system, tire construction and wheel and tire size may change the handling characteristics of your vehicle and may adversely affect the performance of the electronic stability control system. In addition, installing any stereo speakers may interfere with and adversely affect the

electronic stability control system. Reducing the effectiveness of the electronic stability control system could lead to an increased risk of loss of vehicle control, vehicle rollover, personal injury and death.

WARNING: Remember that even advanced technology cannot defy the laws of physics. It's always possible to lose control of a vehicle due to inappropriate driver input for the conditions. Aggressive driving on any road condition can cause you to lose control of your vehicle increasing the risk of personal injury or property damage. Activation of the electronic stability control system is an indication that at least some of the tires have exceeded their ability to grip the road; this could reduce the operator's ability to control the vehicle potentially resulting in a loss of vehicle control, vehicle rollover, personal injury and death.

The system works by braking individual wheels and reducing engine speed.

SWITCHING STABILITY CONTROL ON AND OFF

WARNING: Vehicle modifications involving braking system, aftermarket roof racks, suspension, steering system, tire construction and wheel and tire size may change the handling characteristics of your vehicle and may adversely affect the performance of the electronic stability control system. In addition, installing any stereo speakers may interfere with and adversely affect the

Stability Control

electronic stability control system. Reducing the effectiveness of the electronic stability control system could lead to an increased risk of loss of vehicle control, vehicle rollover, personal injury and death.



WARNING: Remember that even advanced technology cannot defy the laws of physics. It's always possible to lose control of a vehicle due to inappropriate driver input for the conditions. Aggressive driving on any road condition can cause you to lose control of your vehicle increasing the risk of personal injury or property damage. Activation of the electronic stability control system is an indication that at least some of the tires have exceeded their ability to grip the road; this could reduce the operator's ability to control the vehicle potentially resulting in a loss of vehicle control, vehicle rollover, personal injury and death.

The system turns on when you switch the power on and you cannot switch the system off.

The system is disabled when you shift into reverse (R).

STABILITY CONTROL INDICATOR



If it does not illuminate when you switch the power on, or remains on, this indicates a malfunction. Have your vehicle checked by an authorized dealer as soon as possible.

Steering

ELECTRIC POWER STEERING

ELECTRIC POWER STEERING PRECAUTIONS



WARNING: The electric power steering system has diagnostic checks that continuously monitor the system. If a fault is detected, a message displays in the information display. Stop your vehicle as soon as it is safe to do so. Switch the vehicle off. After at least 10 seconds, switch the vehicle on and watch the information display for a steering system warning message. If a steering system warning message returns, have the system checked as soon as possible.



WARNING: If the system detects an error, you may not feel a difference in the steering, however a serious condition may exist. Have your vehicle checked as soon as possible. Failure to do so may result in loss of steering control.

Adapt your speed and driving behavior according to reduced steering assist.

Extreme continuous steering may increase the effort to steer. This occurs to prevent internal overheating and damage to the steering system. If this occurs, you will not lose the ability to steer your vehicle manually nor will it cause damage to the system. Normal steering and driving allows the system to cool down and steering assist returns to normal.

Note: *There is no fluid reservoir to check or fill.*

STEERING – TROUBLESHOOTING

STEERING – WARNING INDICATORS



The electric power steering system indicator illuminates if the system detects a fault during the continuous diagnostic checks.

Note: *If a red warning message displays, stop your vehicle as soon as it is safe to do so.*

STEERING – INFORMATION MESSAGES

Message	Action
Steering Fault Service Now	The power steering system has detected a condition that requires service. Have your vehicle checked as soon as possible.
Steering Loss Stop Safely	The power steering system is not working. Stop your vehicle in a safe place. Have your vehicle checked as soon as possible.
Steering Assist Fault Service Required	The power steering system has detected a condition that requires service. Have your vehicle checked as soon as possible.

Parking Aids

PARKING AID PRECAUTIONS

 **WARNING:** To help avoid personal injury, always use caution when in reverse (R) and when using the sensing system.

 **WARNING:** The system may not detect objects with surfaces that absorb reflection. Always drive with due care and attention. Failure to take care may result in a crash.

 **WARNING:** Traffic control systems, fluorescent lamps, inclement weather, air brakes, external motors and fans may affect the correct operation of the sensing system. This may cause reduced performance or false alerts.

 **WARNING:** The system may not detect small or moving objects, particularly those close to the ground.

 **WARNING:** The parking aid system can only assist you to detect objects when your vehicle is moving at parking speeds. To help avoid personal injury you must take care when using the parking aid system.

 **WARNING:** The system may not function if the sensor is blocked.

 **WARNING:** In cold and severe weather conditions the system may not function. Rain, snow and spray can all limit sensor performance.

 **WARNING:** If damage occurs in the immediate area surrounding the sensor, have your vehicle checked as soon as possible.

Note: *If your vehicle sustains damage leaving the sensors misaligned, this will cause inaccurate measurements or false alerts.*

When you connect a trailer to your vehicle, the rear parking aid detects the trailer and provides an alert. Disable the parking aid when you connect a trailer to prevent the alert.

Note: *The system might detect a connected trailer, if so, it turns parking aid off.*

Note: *Certain add-on devices installed around the bumper or fascia may create false alerts. For example, large trailer hitches, bike or surfboard racks, license plate brackets, bumper covers or any other device could block the normal detection zone of the parking aid system. Aftermarket spare tires or spare tire covers mounted to the rear tailgate could cause false alerts from the park aid system. Remove the add-on device to prevent false alerts.*

Note: *Keep the sensors free of debris. Accumulation of dirt, snow or ice over the sensors can affect the accuracy of the system.*

Do not clean the sensors with sharp objects.

Note: *When using a programmed MyKey, you cannot switch the parking aids off. See MyKey™ (page 79).*

Parking Aids

SWITCHING PARKING AID ON AND OFF - VEHICLES WITH: SYNC 3 LITE, VEHICLES WITHOUT: SYNC



You can turn the system on or off by pressing the parking aid button. If your vehicle does not have a parking aid button, the system can be switched off through the information display menu or from the pop-up message that appears once you shift the transmission into reverse (R).

SWITCHING PARKING AID ON AND OFF - VEHICLES WITH: SYNC 4



Press the parking aid button and use the menu to turn the system on and off.

The system can also be turned off using the pop-up message that appears when you are in reverse (R).

REAR PARKING AID

WHAT IS THE REAR PARKING AID

Rear parking sensors detect objects behind your vehicle when in reverse (R).

REAR PARKING AID LIMITATIONS

There is a decreased coverage area at the outer corners.

The rear parking aid sensors are active when your vehicle is in reverse (R) and the vehicle speed is less than 11 mph (18 km/h).

The sensor coverage area is up to 71 in (180 cm) from the rear bumper.

The rear parking aid detects large objects when you shift into reverse (R) and any of the following occur:

- Your vehicle is moving backward at a low speed.
- Your vehicle is stationary but an object is approaching the rear of your vehicle at a low speed.
- Your vehicle is moving backward at a low speed and an object is moving towards your vehicle, for example another vehicle at a low speed.

The system shall provide no audible warning for the object behind the vehicle when in neutral (N) gear.

LOCATING THE REAR PARKING AID SENSORS



The rear parking aid sensors are in the rear bumper.

Parking Aids

REAR PARKING AID AUDIBLE WARNINGS

A warning tone sounds when your vehicle approaches an object. As your vehicle moves closer to an object, the rate of the tone increases. The warning tone continuously sounds when an object is 12 in (30 cm) or less from the rear bumper.

If your vehicle remains stationary for a few seconds, the audible warning turns off. If your vehicle moves backward the tone sounds again.

Note: *When the parking aid system sounds a tone, the audio system could reduce the set volume.*

FRONT PARKING AID

WHAT IS THE FRONT PARKING AID

Front parking sensors detect objects in front of your vehicle.

FRONT PARKING AID LIMITATIONS

The front parking aid sensors are active when your vehicle is in any position other than park (P) and the vehicle speed is less than 5 mph (8 km/h).

The sensor coverage area is up to 28 in (70 cm) from the front bumper.

If your vehicle is in reverse (R), the front parking aid detects objects and provides an audible warning when your vehicle is moving at a low speed and when an object is moving toward your vehicle, for example, another vehicle at a low speed. If your vehicle remains stationary for a few seconds, the audible warning turns off. Visual indication is always active in reverse (R).

If your vehicle is in any forward gear, the front parking aid provides audible warnings and a visual indication when your vehicle is moving at a speed of 5 mph (8 km/h) or below and the system detects an object within the detection zone. If your vehicle remains stationary for a few seconds, the visual indication and audible warning turns off.

If your vehicle is in neutral (N), the front and rear sensors provide a visual indication only when your vehicle is moving below a speed of 5 mph (8 km/h) and the system detects obstacles inside the detection areas. Once your vehicle stops, the visual indication and audible warning stops after a few seconds.

LOCATING THE FRONT PARKING AID SENSORS



The front parking aid sensors are in the front bumper.

FRONT PARKING AID AUDIBLE WARNINGS

A warning tone sounds when there is an object within 28 in (70 cm) from the front bumper. As your vehicle moves closer to an object, the rate of the tone increases.

Parking Aids

The warning tone continuously sounds when an object is 12 in (30 cm) or less from the front bumper.

Note: *If the detected object is 12 in (30 cm) or less from your vehicle, visual indication remains on.*

SIDE PARKING AID

WHAT IS THE SIDE PARKING AID

The front and rear outermost parking aid sensors map objects that are near to the sides of your vehicle.

SIDE PARKING AID LIMITATIONS

The sensor coverage is up to 24 in (60 cm) from the sides of your vehicle.

The side parking aid may not function if:

- Your vehicle remains stationary for over two minutes.
- The anti-lock brake system activates.
- The traction control system activates.
- Your vehicle is in park (P).
- The steering wheel angle information is not available. To reset the steering wheel angle information, drive straight for at least 492 ft (150 m) above 19 mph (30 km/h).

Note: *If you switch traction control off, the side sensing system also turns off.*

To reinitialize the system, drive the length of your vehicle.

The side parking aid does not detect an object that is moving toward the side of your vehicle, for example another vehicle moving at a low speed, if it does not pass a front or rear parking aid sensor.

If the transmission is in reverse (R), the side sensing system provides audible warnings. When your vehicle is moving slowly, the system detects obstacles within 24 in (60 cm) and are inside the driving path of your vehicle. If your vehicle remains stationary for a few seconds, the audible warning turns off. Visual indication is always present in reverse (R).

If your vehicle is in neutral (N), the side sensing system provides visual indication only when your vehicle is moving slowly and there is a front or rear parking aid obstacle detected, and the side obstacle is within 24 in (60 cm) from the side of your vehicle. If your vehicle remains stationary for a few seconds, the visual indication turns off.

If the transmission is in drive (D) or any other forward gear, the side sensing system provides audible and visual warnings. When your vehicle is moving slowly, the system detects obstacles within 24 in (60 cm) and are inside the driving path of your vehicle. If your vehicle remains stationary for a few seconds, the visual indication and audible warning turns off.

LOCATING THE SIDE PARKING AID SENSORS



Parking Aids

The side parking sensors are in the front and rear bumpers.

SIDE PARKING AID AUDIBLE WARNINGS

When the side parking aid detects an object within the coverage area and the driving path of your vehicle, an audible warning sounds. As your vehicle moves closer to the object, the rate of the tone increases.

PARKING AID INDICATORS



The system provides object distance indication through the information display.

- As the distance to the object decreases, the indicator blocks illuminate and move toward the vehicle icon.
- If there is no object detected, the distance indicator blocks are grey.

Visual indication remains on when the transmission is in reverse (R). When you stop your vehicle, visual indication turns off after four seconds.

If the parking aids are not available, the side distance indicator blocks do not display.

PARKING AIDS – TROUBLESHOOTING

PARKING AIDS – INFORMATION MESSAGES

If a fault is present in the parking aids, a warning message appears in the instrument cluster or the information display.

Parking Aids

Message	Details
Park Aid Fault	The system has malfunctioned. Have your vehicle checked as soon as possible.
Check Park Aid	The system has malfunctioned. Have your vehicle checked as soon as possible.
Front Park Aid Not Available Sensor Blocked See Manual	A sensor is blocked or the system has malfunctioned. Clean the bumper or remove any obstruction. If the message continues to appear, have your vehicle checked as soon as possible.
Check Front Park Aid	The system detects a condition that requires service. Have your vehicle checked as soon as possible.
Check Rear Park Aid	The system detects a condition that requires service. Have your vehicle checked as soon as possible.
Front Park Aid On Off	Displays the park aid status.
Rear Park Aid On Off	Displays the park aid status.

Rear View Camera

WHAT IS THE REAR VIEW CAMERA

The rear view camera provides a video image of the area behind your vehicle when the transmission is in reverse (R). During operation, guide lines appear in the display that represents the path of your vehicle and proximity to objects behind it.

REAR VIEW CAMERA PRECAUTIONS



WARNING: The rear view camera system is a reverse aid supplement device that still requires the driver to use it in conjunction with the interior and exterior mirrors for maximum coverage.



WARNING: Objects that are close to either corner of the bumper or under the bumper, might not be seen on the screen due to the limited coverage of the camera system.



WARNING: Objects above the camera may not be visible. Check the area behind your vehicle when necessary.



WARNING: Reverse your vehicle slowly. Failure to follow this instruction could result in the loss of control of your vehicle, personal injury or death.



WARNING: Use caution when the rear cargo door is ajar. If the rear cargo door is ajar, the camera will be out of position and the video image could be incorrect. All guide lines disappear when the rear cargo door is ajar. Failure to follow this instruction could result in personal injury.



WARNING: Do not switch the camera features on or off when your vehicle is moving.

Note: *When towing, the camera only sees what you are towing. This might not provide adequate coverage and you might not see some objects. In some vehicles, the guide lines may disappear when you connect the trailer tow connector.*

REAR VIEW CAMERA LIMITATIONS

The system may not correctly operate in any of the following conditions:

- Nighttime or dark areas if the reverse lamps are not operating.
- If the camera is obstructed. Clean the lens with a soft, lint-free cloth and non-abrasive cleaner.
- The camera is misaligned due to the rear door ajar or damage to the rear of your vehicle.

Rear View Camera

LOCATING THE REAR VIEW CAMERA

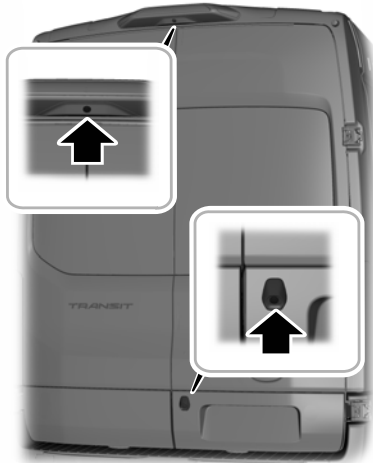

E254267

The rear view camera is below the central high mounted stop lamp or on the rear cargo door.

REAR VIEW CAMERA GUIDE LINES

Note: Active guide lines are only available when the transmission is in reverse (R).

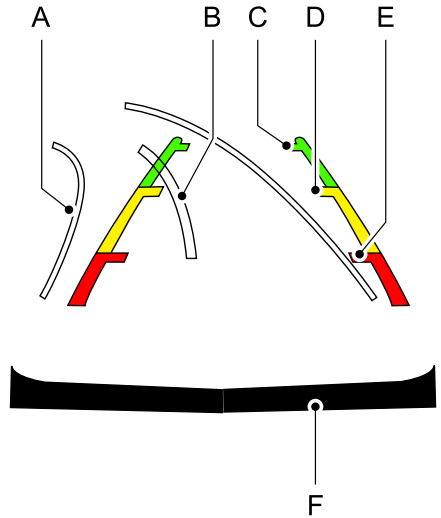

- A Active guide lines.
- B Centerline.
- C Fixed guide line: Green zone.
- D Fixed guide line: Yellow zone.
- E Fixed guide line: Red zone.
- F Rear bumper.

Active guide lines only show with fixed guide lines. To use active guide lines, turn the steering wheel to point the guide lines toward an intended path. If the steering wheel position changes while reversing, your vehicle might deviate from the intended path.

Rear View Camera

The fixed and active guide lines fade in and out depending on the steering wheel position. The active guide lines do not display when the steering wheel position is straight.

Use caution while reversing. Objects in the red zone are closest to your vehicle and objects in the green zone are farther away. Objects get closer to your vehicle as they move from the green zone to the yellow or red zones. Use the side view mirrors and rear view mirror to get better coverage on both sides and rear of your vehicle.

If the vehicle battery is disconnected, the guidelines are not fully functional directly after the battery is reconnected. The guidelines become fully functional after you drive your vehicle forward as straight as possible for five minutes at a minimum speed of 31 mph (50 km/h).

REAR VIEW CAMERA SETTINGS

ZOOMING THE REAR VIEW CAMERA IN AND OUT



WARNING: When manual zoom is on, the full area behind your vehicle may not show. Be aware of your surroundings when using the manual zoom feature.

Selectable settings for this feature are zoom in (+) and zoom out (-). Press the symbol on the camera screen to change the view. The default setting is zoom off.

This allows you to get a closer view of an object behind your vehicle. The zoomed image keeps the bumper in the image to provide a reference. The zoom is only active while the transmission is in reverse (R).

Note: Manual zoom is only available when the transmission is in reverse (R).

Note: Only the centerline shows when you enable manual zoom.

SWITCHING REAR VIEW CAMERA OBJECT DISTANCE INDICATOR ON AND OFF



You can switch this feature on or off in the settings.

When the system detects an object, it displays red, yellow and green distance indicators on the information display.

SWITCHING REAR VIEW CAMERA DELAY ON AND OFF - VEHICLES WITH: SYNC 4

1. Press **Settings** on the touchscreen.
2. Press **Vehicle**.
3. Switch **Rear View Camera Delay** on or off.

Rear View Camera

If you switch this feature on, the image continues to display when you shift out of reverse (R) until:

- You shift to a forward gear and the vehicle speed sufficiently increases.
- You shift in to park (P).

180 Degree Camera

WHAT IS THE 180 DEGREE CAMERA

The 180 degree camera provides an extended image of the area behind your vehicle.

HOW DOES THE 180 DEGREE CAMERA WORK

When you switch the 180 degree view on, the view splits into three images. You can use the right and left outer images when reversing to check for cross traffic and pedestrians.

When you use the 180 degree camera view, objects behind your vehicle are shown extremely stretched and do not appear as actual ratio.

180 DEGREE CAMERA PRECAUTIONS



WARNING: The rear view camera system is a reverse aid supplement device that still requires the driver to use it in conjunction with the interior and exterior mirrors for maximum coverage.



WARNING: Objects that are close to either corner of the bumper or under the bumper, might not be seen on the screen due to the limited coverage of the camera system.



WARNING: Reverse your vehicle slowly. Failure to follow this instruction could result in the loss of control of your vehicle, personal injury or death.



WARNING: Use caution when the rear cargo door is ajar. If the rear cargo door is ajar, the camera will be out of position and the video image could be incorrect. All guide lines disappear when the rear cargo door is ajar. Failure to follow this instruction could result in personal injury.



WARNING: Do not switch the camera features on or off when your vehicle is moving.

Note: *If the image comes on while the transmission is not in reverse (R), have the system inspected by your authorized dealer.*

Note: *When towing, the camera only sees what you are towing. This might not provide adequate coverage and you might not see some objects.*

Note: *Guide lines do not appear when you switch the 180 degree view on.*

SWITCHING THE 180 DEGREE CAMERA ON AND OFF

When you shift to reverse (R) and the rear view camera image appears, press the button in the upper left corner of the touch screen to switch the 180 degree view on. Press the button again to switch it off.

The 180 degree view turns off when you shift into park (P) or into any forward gear and the vehicle speed sufficiently increases.

Note: *Whenever you shift to reverse (R) the standard rear view camera image with guidelines is the default view.*

360 Degree Camera

WHAT IS THE 360 DEGREE CAMERA

The 360 degree camera system provides visibility around your vehicle in parking maneuvers such as:

- Centering in a parking space.
- Obstacles near your vehicle.
- Parallel parking.

The 360 degree camera system consists of front, side and rear cameras.

HOW DOES THE 360 DEGREE CAMERA WORK

The 360 degree camera system consists of front, side and rear cameras.

The 360 Degree Camera system:

- Allows you to see what is directly in front of or behind your vehicle.
- Provides a cross traffic view in front of and behind your vehicle.
- Allows you to see a top-down view of the area outside your vehicle, including the blind spots and obstacles near your vehicle.

360 DEGREE CAMERA PRECAUTIONS



WARNING: The 360 degree camera system still requires the driver to use it in conjunction with looking out of the windows, and checking the interior and exterior mirrors for maximum coverage.



WARNING: Objects that are close to either corner of the bumper or under the bumper, might not be seen on the screen due to the limited coverage of the camera system.



WARNING: When manual zoom is on, the full area behind your vehicle may not show. Be aware of your surroundings when using the manual zoom feature.



WARNING: Do not switch the camera features on or off when your vehicle is moving.



WARNING: You are responsible for controlling your vehicle at all times. The system is designed to be an aid and does not relieve you of your responsibility to drive with due care and attention. Failure to follow this instruction could result in the loss of control of your vehicle, personal injury or death.

360 DEGREE CAMERA LIMITATIONS

Note: Use caution if a door is ajar. The camera could be out of position and the image could be incorrect.

LOCATING THE 360 DEGREE CAMERAS

Rear View Camera

The rear view camera is below the central high mounted stop lamp or on the rear cargo door. It provides a video image of the area behind your vehicle.

360 Degree Camera

Front View Camera

The front view camera is in the front grille. It provides a video image of the area in front of your vehicle.

Side View Camera

The side view camera is on the exterior mirror. It provides a video image of the area on both sides of your vehicle to aid you when parking.

360 DEGREE CAMERA GUIDE LINES

Note: Active guide lines are only available when the transmission is in reverse (R).

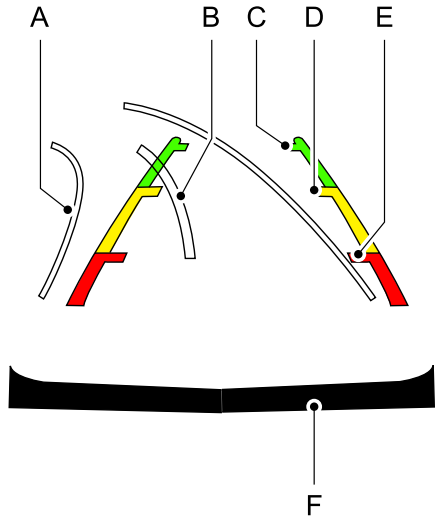

- A Active guide lines.
- B Centerline.
- C Fixed guide line: Green zone.
- D Fixed guide line: Yellow zone.
- E Fixed guide line: Red zone.
- F Rear bumper.

Active guide lines only show with fixed guide lines. Turn the steering wheel to point the guide lines toward an intended path. If the steering wheel position changes when reversing, your vehicle could deviate from the intended path.

The fixed and active guide lines fade in and out depending on the steering wheel position. The active guide lines do not display when the steering wheel position is straight.

360 Degree Camera

Objects in the red zone are closest to your vehicle and objects in the green zone are farther away. Objects get closer to your vehicle as they move from the green zone to the yellow or red zones. Use the side view mirrors and rear view mirror to get better coverage on both sides and rear of your vehicle.

Keep Out Zone

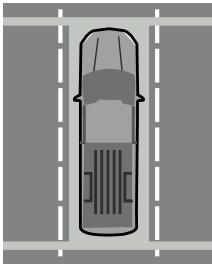

The keep out zone is represented by the yellow dotted lines running parallel to your vehicle.

SWITCHING THE 360 DEGREE CAMERA ON AND OFF



The 360 degree camera system button is on the instrument panel. The front and rear cameras have multiple screens which consist of:

- Normal view.
- Normal view with 360.
- Split view.

Note: *The rear view camera activates when you switch into reverse (R). Additional views are then accessible on the touchscreen.*

When in park (P), neutral (N) or drive (D), the front and 360 degree views display when the button is pressed.

When in reverse (R), the rear and the 360 degree views display.

Note: *The 360 degree camera view turns off when the vehicle speed increases, except when in reverse (R).*

SWITCHING THE 360 DEGREE CAMERA VIEW



Press to access the different camera views.



Front normal view provides an image of what is directly in front of your vehicle.



Front split view provides an extended view of what is in front of your vehicle.



Normal + 360 degree view contains the normal camera view next to a 360 degree camera view.



Rear normal view provides an image of what is directly behind your vehicle.



Rear split view provides an extended view of what is behind your vehicle.



Zooms in on the 360 degree image.

Active Park Assist

WHAT IS ACTIVE PARK ASSIST

Assists you with parking in and out of parking spaces.

ACTIVE PARK ASSIST PRECAUTIONS



WARNING: You must remain in your vehicle when the system turns on. The system is designed to be an aid and does not relieve you of your responsibility to drive with due care and attention. At all times, you are responsible for controlling your vehicle, supervising the system and intervening if required. Failure to follow this instruction could result in the loss of control of your vehicle, personal injury or death.



WARNING: The sensors may not detect objects in heavy rain or other conditions that cause interference.



WARNING: Do not use the system with accessories that extend beyond the front or rear of your vehicle, for example a trailer hitch or bike rack. The system is not able to make corrections for the additional length of the accessories.

SWITCHING ACTIVE PARK ASSIST ON AND OFF - VEHICLES WITH: SYNC 3 LITE, VEHICLES WITHOUT: SYNC



The active park assist button is next to the gearshift lever.

Press the button to activate active park assist. Press again to switch between parking modes.

Canceling Active Park Assist

To cancel parking assistance at any time, press the active park assist button or turn the steering wheel.

Note: *It also cancels when your vehicle exceeds 6 mph (9 km/h).*

Brake System Intervention

When active park assist is controlling the steering, it may under certain conditions apply the brakes to slow or stop your vehicle.

Note: *This could cause the parking assistance to cancel.*

SWITCHING ACTIVE PARK ASSIST ON AND OFF - VEHICLES WITH: SYNC 4



Press the parking button .



Press the active park assist icon on the touchscreen.

The active park assist turns on and automatically searches for parking spaces, or if your vehicle is parked for exiting ways.

Canceling Active Park Assist

To cancel parking assistance at any time, press the parking button or move the steering wheel.

Note: *Active park assist also cancels when your vehicle exceeds 6 mph (10 km/h).*

Active Park Assist

Brake System Intervention

When active park assist is controlling the steering, it could under certain conditions apply the brakes to slow or stop your vehicle.

Note: *This could cause the parking assistance to cancel.*

ENTERING A PARKING SPACE

-  Press the parking button.
-  Press the active park assist icon on the touchscreen.
- Slowly drive your vehicle parallel to the other parked vehicles.

Note: *Park assist automatically searches for possible parking spaces displaying them on the touchscreen, and highlights the preferred parking space.*

Note: *A tone sounds and a message appears in the information display when active park assist finds a suitable parking space.*

- Bring your vehicle to a complete standstill.

Note: *A circular arrow sign appears over the highlighted parking space if the parking mode can be changed.*

-  Press to select the parking mode if the icon appears over the selected parking space.
- Follow the instructions on the screen.

Note: *You can slow down your vehicle at any time by pressing the brake pedal.*

EXITING A PARKING SPACE

The system assists leaving only parallel parking spaces.

- Press the active park assist button.
- Use the turn signal lever to choose the direction to leave.
- Release the steering wheel and shift into reverse (R).
- Follow the instructions on the information display.

Note: *You can slow down your vehicle at any time by pressing the brake pedal.*

Note: *After the system drives your vehicle to a position where you can exit the parking space in a forward movement, a message appears instructing you to take full control of your vehicle.*

ACTIVE PARK ASSIST – TROUBLESHOOTING

ACTIVE PARK ASSIST – INFORMATION MESSAGES

Message	Details
Active Park Fault	The system requires service. Have your vehicle checked as soon as possible.

ACTIVE PARK ASSIST – FREQUENTLY ASKED QUESTIONS

Why does active park assist not operate correctly?

- The system is unable to detect a vehicle, curb or object to park next to or in between. The system needs boundary objects to operate correctly.

Active Park Assist

Why does active park assist not search for a parking space?

- You have switched traction control off.
- The transmission is in reverse (R). Your vehicle must be moving forward to be able to detect a parking space.

Why does active park assist not offer a parking space?

- The sensors could be blocked. For example, snow, ice or large accumulations of dirt. Blocked sensors can affect how the system functions.
- The sensors in the front or rear bumper could be damaged.
- There is not enough room in the parking space for your vehicle to safely park.
- There is not enough space for the parking maneuver on the opposite side of the parking space.
- The parking space is more than 1.6 yd (1.5 m) or less than 0.5 yd (0.5 m) away from your vehicle.
- Your vehicle's speed is greater than 21.7 mph (35 km/h) for parallel parking or greater than 18.6 mph (30 km/h) for perpendicular parking.
- You recently disconnected or replaced the battery. After you reconnect the battery you must drive your vehicle on a straight road for a short period of time.

Why does active park assist not correctly position the vehicle into a parking space?

- An irregular curb along the parking space prevents the system from correctly aligning your vehicle.
- Vehicles or objects bordering the space could not be correctly parked.
- Your vehicle stopped too far past the parking space.

- The tires are not correctly installed or maintained. For example, using a spare tire, not inflated correctly, improper size, or of different sizes.
- A repair or alteration changed the detection capabilities.
- A parked vehicle has a high attachment. For example, a salt sprayer, snowplow or moving truck bed.
- The parking space length or position of parked objects changes after your vehicle passes the space.
- The temperature around your vehicle quickly changes. For example, driving from a heated garage into a cold outside temperature, or after leaving a car wash.

Cruise Control

WHAT IS CRUISE CONTROL

Cruise control lets you maintain a set speed without keeping your foot on the accelerator pedal.

Requirements

Use cruise control when the vehicle speed is greater than 20 km/h in metric units or 15 mph in imperial units.

SWITCHING CRUISE CONTROL ON AND OFF



WARNING: Do not use cruise control on winding roads, in heavy traffic or when the road surface is slippery. This could result in loss of vehicle control, serious injury or death.

The cruise controls are on the steering wheel.

Switching Cruise Control On



Press the button to put the system in standby mode.

Switching Cruise Control Off



Press the button when in standby mode or switch the ignition off.

Note: When you switch cruise control off the set speed clears.

SETTING THE CRUISE CONTROL SPEED



WARNING: When you are going downhill, your vehicle speed could increase above the set speed. The system does not apply the brakes.

Drive to the speed you prefer.

SET+

Press the buttons to set the current speed.

SET-

Take your foot off the accelerator pedal.

Note: The set speed appears in the instrument cluster display.

Changing the Set Speed

SET+

Press the button to increase the set speed in small increments. Press and hold the button to accelerate. Release the button when you have reached your preferred speed.

SET-

Press the button to decrease the set speed in small increments. Press and hold the button to decelerate. Release the button when you have reached your preferred speed.

Note: If you accelerate by pressing the accelerator pedal, the set speed does not change. When you release the accelerator pedal, your vehicle returns to the speed that you previously set.

CANCELING THE SET SPEED



Press the button, or tap the brake pedal to cancel the set speed.

Cruise Control

Note: *The system remembers the set speed.*

Note: *The system cancels if the vehicle speed drops below 10 mph (16 km/h) under the set speed when driving uphill.*

RESUMING THE SET SPEED



Press the button.

CRUISE CONTROL INDICATORS



Illuminates when you switch the system on.

Adaptive Cruise Control

HOW DOES ADAPTIVE CRUISE CONTROL WORK

Adaptive cruise control uses radar and camera sensors to maintain a set gap between your vehicle and the vehicle in front of you.

ADAPTIVE CRUISE CONTROL PRECAUTIONS

 **WARNING:** You are responsible for controlling your vehicle at all times. The system is designed to be an aid and does not relieve you of your responsibility to drive with due care and attention. Failure to follow this instruction could result in the loss of control of your vehicle, personal injury or death.

 **WARNING:** Do not use adaptive cruise control on winding roads, in heavy traffic or when the road surface is slippery. This could result in loss of vehicle control, serious injury or death.

 **WARNING:** Pay close attention to changing road conditions such as entering or leaving a highway, on roads with intersections or roundabouts, roads without visible lanes of travel, roads that are unpaved, or steep slopes. Failure to follow this instruction could result in the loss of control of your vehicle, personal injury or death.

 **WARNING:** The system is not a crash warning or avoidance system.

 **WARNING:** Do not use the system when towing a trailer that has aftermarket electronic trailer brake controls. Failure to follow this instruction could result in the loss of control of your vehicle, personal injury or death.

 **WARNING:** Do not use tire sizes other than those recommended because this can affect the normal operation of the system. Failure to do so may result in a loss of vehicle control, which could result in serious injury.

 **WARNING:** Do not use the system with a snow plow blade installed.

 **WARNING:** In situations with poor visibility, such as fog, heavy rain or other inclement weather, you may need to override or completely switch off the system.

When Following a Vehicle

 **WARNING:** When following a vehicle that is braking, your vehicle does not always decelerate quickly enough to avoid a crash without driver intervention. Apply the brakes when necessary. Failure to follow this instruction could result in personal injury or death.

Hilly Condition Usage

Select a lower gear when the system is active in situations such as prolonged downhill driving on steep slopes, for example in mountainous areas.

Adaptive Cruise Control

ADAPTIVE CRUISE CONTROL LIMITATIONS

Sensor Limitations

WARNING: On rare occasions, detection issues can occur due to the road infrastructures, for example bridges, tunnels and safety barriers. In these cases, the system may brake late or unexpectedly. At all times, you are responsible for controlling your vehicle, supervising the system and intervening, if required.

WARNING: If the system malfunctions, have your vehicle checked as soon as possible.

WARNING: Large contrasts in outside lighting can limit sensor performance.

WARNING: The system only warns of vehicles detected by the radar sensor. In some cases there may be no warning or a delayed warning. Apply the brakes when necessary. Failure to follow this instruction could result in personal injury or death.

WARNING: The system may not detect stationary or slow moving vehicles below 6 mph (10 km/h).

WARNING: The system does not detect pedestrians or objects in the road.

WARNING: The system does not detect oncoming vehicles in the same lane.

WARNING: The system may not operate properly if the sensor is blocked. Keep the windshield free from obstruction.

WARNING: The sensor may incorrectly track lane markings as other structures or objects. This can result in a false or missed warning.



The camera is mounted behind the interior mirror.

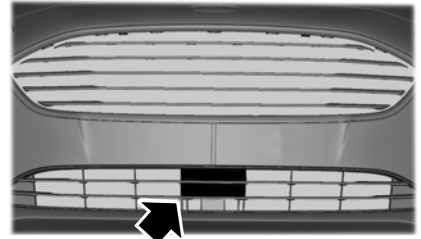

The radar is behind the front grille below the license plate.

Note: You cannot see the sensor. It is behind a fascia panel.

Note: Keep the front of your vehicle free of dirt, metal badges or objects. Vehicle front protectors, aftermarket lights, additional paint or plastic coatings could also degrade sensor performance.

Adaptive Cruise Control

A message displays if something obstructs the camera or the sensor. When something blocks the sensor, the system cannot detect a vehicle ahead and does not function. See **Adaptive Cruise Control – Information Messages** (page 272).

The radar sensor has a limited field of view. It may not detect vehicles at all or detect a vehicle later than expected in some situations. The lead vehicle image does not illuminate if the system does not detect a vehicle in front of you.

Detection Issues Can Occur:

A

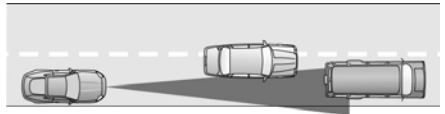

B



C

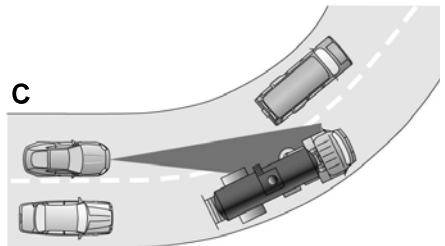

- A When driving on a different lane than the vehicle in front.
- B With vehicles that edge into your lane. The system can only detect these vehicles once they move fully into your lane.
- C There may be issues with the detection of vehicles in front when driving into and coming out of a bend or curve in the road.

In these cases, the system may brake late or unexpectedly.

If something hits the front end of your vehicle or damage occurs, the radar-sensing zone may change. This could cause missed or false vehicle detection.

Adaptive Cruise Control

Optimal system performance requires a clear view of the road by the windshield camera.

Optimal performance may not occur if:

- The camera is blocked.
- There is poor visibility or lighting conditions.
- There are bad weather conditions.

SWITCHING ADAPTIVE CRUISE CONTROL ON AND OFF

The cruise controls are on the steering wheel. See **What Is Cruise Control** (page 263).

Switching Adaptive Cruise Control On



Press the button to set the system in standby mode.

The indicator, current gap setting and set speed appear in the information display.

Switching Adaptive Cruise Control Off



Press the button when the system is in standby mode, or switch the ignition off.

Note: You erase the set speed when you switch the system off.

ADAPTIVE CRUISE CONTROL AUTOMATIC CANCELLATION

The system does not operate if the vehicle speed is below 15 mph when in imperial units or 20 km/h when in metric units. A tone sounds and adaptive braking releases if the vehicle speed falls below 15 mph when in imperial units or 20 km/h when in metric units.

Automatic cancellation can also occur when:

- The tires lose traction.
- You apply the parking brake.

Note: If the engine speed drops too low, the instrument cluster display advises you to shift to a lower gear.

The system could deactivate or prevent activating when requested if:

- The vehicle has a blocked sensor.
- The brake temperature is too high.
- There is a failure in the system.

SETTING THE ADAPTIVE CRUISE CONTROL SPEED

Drive to the speed you prefer.



Press the toggle button upward or downward to set the current speed.



Take your foot off the accelerator pedal.

The indicator, current gap setting and set speed appear in the information display.



A vehicle image illuminates if there is a vehicle detected in front of you.

Note: When adaptive cruise control is active, the speedometer may vary slightly from the set speed displayed in the information display.

Adaptive Cruise Control

Manually Changing the Set Speed

SET+ Press and release the toggle button upward to increase the set speed in small increments.

Press and hold the toggle button upward to increase the set speed in large increments. Release the button when you reach the speed you prefer.

SET- Press and release the toggle button downward to decrease the set speed in small increments.

Press and hold the toggle button downward to decrease the set speed in large increments. Release the button when you reach the speed you prefer.

Press the accelerator or brake pedal until you reach the speed you prefer. Press the toggle button upward or downward to select the current speed as the set speed.

The system may apply the brakes to slow the vehicle to the new set speed. The set speed displays continuously in the information display when the system is active.

SETTING THE ADAPTIVE CRUISE CONTROL GAP

 Press the button to cycle through the four gap settings.



The selected gap appears in the instrument cluster display as shown by the bars in the image.

Note: *The gap setting is time dependent and therefore, the distance adjusts with your vehicle speed.*

Note: *It is your responsibility to select a gap appropriate to the driving conditions.*

Adaptive Cruise Control Gap Settings

Graphic Display, Bars Indicated Between Vehicles	Gap Distance	Dynamic Behavior
1	Closest.	Sport.
2	Close.	Normal.
3	Medium.	Normal.
4	Far.	Comfort.

Each time you switch the system on, it selects the last chosen gap setting.

Following a Vehicle

When a vehicle ahead of you enters the same lane or a slower vehicle is ahead in the same lane, the vehicle speed adjusts to maintain the gap setting.

Note: *When you are following a vehicle and you switch on a turn signal lamp, adaptive cruise control may provide a small, temporary acceleration to help you pass.*

Your vehicle maintains a consistent gap from the vehicle ahead until:

- The vehicle in front of you accelerates to a speed above the set speed.
- The vehicle in front of you moves out of the lane you are in.
- You set a new gap distance.

Adaptive Cruise Control

The system applies the brakes to slow down your vehicle to maintain a safe gap distance from the vehicle in front of you. The system only applies limited braking. You can override the system by applying the brakes.

Note: *The brakes may emit noise when applied by the system.*

If the system determines that its maximum braking level is not sufficient, an audible warning sounds, a message appears in the instrument cluster display and an indicator flashes when the system continues to brake. Take immediate action.

CANCELING THE SET SPEED



Press the button or tap the brake pedal.

The set speed does not erase.

RESUMING THE SET SPEED



Press the button.

Your vehicle speed returns to the previously set speed and gap setting. The set speed displays continuously in the information display when the system is active.

Note: *Only use resume if you are aware of the set speed and intend to return to it.*

OVERRIDING THE SET SPEED



WARNING: If you override the system by pressing the accelerator pedal, it does not automatically apply the brakes to maintain a gap from any vehicle ahead.

When you press the accelerator pedal, you override the set speed and gap distance.

Use the accelerator pedal to intentionally exceed the set speed limit.

When you override the system, the green indicator illuminates and the vehicle icon does not appear in the instrument cluster display.

The system resumes operation when you release the accelerator pedal. The vehicle speed decreases to the set speed, or a lower speed if following a slower vehicle.

ADAPTIVE CRUISE CONTROL INDICATORS



Illuminates when you switch adaptive cruise control on. The color of the indicator changes to indicate the system status.

White indicates the system is on but inactive.

Green indicates that you set the speed and the system is active.

SWITCHING FROM ADAPTIVE CRUISE CONTROL TO CRUISE CONTROL



WARNING: Normal cruise control will not brake when your vehicle is approaching slower vehicles. Always be aware of which mode you have selected and apply the brakes when necessary.

1. Using the instrument cluster display controls on the steering wheel, select **Settings**.
2. Select **Driver Assistance**.
3. Select **Cruise Control**.

Adaptive Cruise Control

4. Select **Mode**.
5. Select a setting and press the **OK** button.



The cruise control indicator replaces the adaptive cruise control indicator if you select normal cruise control. The gap setting does not display, and the system does not respond to lead vehicles. Automatic braking remains active to maintain the set speed. The system remembers the last setting when you start your vehicle.

INTELLIGENT ADAPTIVE CRUISE CONTROL

HOW DOES INTELLIGENT ADAPTIVE CRUISE CONTROL WORK

Intelligent adaptive cruise control combines speed sign recognition and navigation map data with adaptive cruise control to adjust the cruise set speed to the speed limit detected by the speed sign recognition system. As the system detects new speed signs, the set speed updates.

There are limitations that affect the accuracy of the speed sign recognition system and its ability to determine the current speed limit. The intelligent adaptive cruise control system and its ability to determine the current speed limit shares these limitations. See **Speed Sign Recognition** (page 306).

Note: *The adaptive cruise control gap setting operates normally when the feature is enabled.*

INTELLIGENT ADAPTIVE CRUISE CONTROL PRECAUTIONS



WARNING: You are responsible for controlling your vehicle at all times. The system is designed to be an aid and does not relieve you of your responsibility to drive with due care and attention. Failure to follow this instruction could result in the loss of control of your vehicle, personal injury or death.

INTELLIGENT ADAPTIVE CRUISE CONTROL LIMITATIONS

The speed limit information provided by the navigation map data could be inaccurate or out of date.

The system may not detect and read speed limit signs with conditional information, for example, when a sign is flashing, during specific time ranges, or when children are present.

Note: *The system does not set the vehicle speed to speed limits shown with a supplementary traffic sign.*

Under certain conditions, the system may not adjust the vehicle speed until after your vehicle passes the speed limit.

SWITCHING INTELLIGENT MODE ON AND OFF

1. Using the instrument cluster display controls on the steering wheel, select **Settings**.
2. Select **Driver Assistance**.
3. Select **Cruise Control**.
4. Select **Mode**.
5. Select a setting and press the **OK** button.

Adaptive Cruise Control

ADJUSTING THE SET SPEED TOLERANCE

1. Using the instrument cluster display controls on the steering wheel, select **Settings**.
2. Select **Driver Assistance**.
3. Select **Cruise Control**.
4. Select **Tolerance**.
5. Select a setting and press the **OK** button.

INTELLIGENT ADAPTIVE CRUISE CONTROL ALERTS

If the speed sign recognition system detects a speed limit below the minimum adaptive cruise control set speed, a tone sounds and the system returns to standby mode.

INTELLIGENT ADAPTIVE CRUISE CONTROL INDICATORS



If you select this mode, a bracket appears around the set speed and the detected speed limit sign in the instrument cluster display.

ADAPTIVE CRUISE CONTROL – TROUBLESHOOTING

ADAPTIVE CRUISE CONTROL – INFORMATION MESSAGES - VEHICLES WITH: ADAPTIVE CRUISE CONTROL

Note: Depending on your vehicle options and instrument cluster type, not all messages display or are available.

Note: The system could abbreviate or shorten certain messages depending upon which cluster type you have.

Adaptive Cruise Control

Message	Details
Adaptive Cruise Not Available Sensor Blocked See Manual	Displays when the sensor has reduced visibility.
Adaptive Cruise Not Available	Displays when the system is not available.
Adaptive Cruise Malfunction	The system has malfunctioned. Have your vehicle checked as soon as possible.
Normal Cruise Active Adaptive Braking Off	You have switched normal cruise control on. Adaptive braking turns off.

Adaptive Cruise Control

ADAPTIVE CRUISE CONTROL – INFORMATION MESSAGES - VEHICLES WITH: INTELLIGENT ADAPTIVE CRUISE CONTROL

Message	Details
Intelligent Cruise Control Speed Sign Recognition Not Available	Navigation system based speed limit information is not available. If the message continues to appear, have your vehicle checked as soon as possible.

Drive Mode Control

WHAT IS DRIVE MODE CONTROL

Your vehicle has various drive modes that you can select for different driving conditions. Depending on the drive mode that you select, the system adjusts various vehicle settings.

SELECTING A DRIVE MODE - VEHICLES WITH: SYNC 3 LITE, VEHICLES WITHOUT: SYNC



Repeatedly press the button on the instrument panel to scroll through the available drive modes. Release the button to confirm your selected drive mode.

SELECTING A DRIVE MODE - VEHICLES WITH: SYNC 4



Press the button on the instrument panel to directly access the drive modes on the touchscreen.

As a secondary option:

1. Press **Features** on the touchscreen.
2. Press **DRIVE MODES**.
3. Select a setting.

DRIVE MODES - GASOLINE

ECO



Vehicle settings suited for economical driving.

Note: In fleet vehicles, if you switch off your vehicle in a mode other than Eco, the system prompts you to return to this previous mode when you next start your vehicle. If you ignore the selection prompt, the system defaults to Eco mode.

NORMAL (If Equipped)



Vehicle settings suited for balanced driving.

Note: If you switch off your vehicle in a mode other than Normal, the system prompts you to return to this previous mode when you next start your vehicle. If you ignore the selection prompt, the system defaults to Normal mode.

SLIPPERY



Vehicle settings suited for driving on slippery roads.

TOW/HAUL



Vehicle settings suited for towing or hauling.

TRAIL - AWD



Vehicle settings suited for driving on unpaved roads.

Note: Auto-start-stop is disabled when you select this mode.

Drive Mode Control

DRIVE MODES - BATTERY ELECTRIC VEHICLE

ECO



Vehicle settings suited for economical driving.

Note: *The system remembers the last setting when you start your vehicle.*

NORMAL



Vehicle settings suited for balanced driving.

Note: *The system remembers the last setting when you start your vehicle.*

SLIPPERY



Vehicle settings suited for driving on slippery roads.

Note: *If you switch off your vehicle in **Slippery** mode, the system prompts you to return to this mode when you next start your vehicle. If you ignore the selection prompt, the system defaults to **Normal** mode.*

DRIVE MODE CONTROL – TROUBLESHOOTING

DRIVE MODE CONTROL – INFORMATION MESSAGES

Message	Details
Drive Mode Not Available	The system is not available. If it is still not available the next time you switch the ignition on, the system has malfunctioned. Have your vehicle checked as soon as possible.

Eco Coach

WHAT IS ECO COACH

Eco coach is designed to monitor certain driving characteristics to help you drive more efficiently.

HOW DOES ECO COACH WORK

Eco coach provides feedback through the instrument cluster display about your driving behaviour.

Note: *The efficiency levels do not result in a defined fuel consumption figure.*

Note: *The system only indicates the efficiency level for the current trip. The system resets each time you switch the ignition on.*

HOW DOES INSTANTANEOUS EFFICIENCY LEVEL WORK

The display ring increases as the instantaneous efficiency level increases and illuminates when it reaches maximum efficiency. The level continuously updates to indicate the efficiency level for the current trip.

VIEWING THE INSTANTANEOUS EFFICIENCY LEVEL

1. Using the information display controls on the steering wheel, select **MyView**.
2. Select **Eco Coach**.

HOW DOES TRIP SUMMARY WORK

The calculated trip summary is shown as four colored bars. The bars travel from left to right as the calculated efficiency levels increase. The bars indicate the average efficiency level for acceleration, deceleration, speed and gear shifting during the total distance traveled by your vehicle for the current trip.

Note: *Vehicles with an automatic transmission do not have a bar for gear shifting.*

VIEWING THE TRIP SUMMARY

1. Using the information display controls on the steering wheel, select **MyView**.
2. Select **Eco Coach**.

Speed Limiter

HOW DOES THE SPEED LIMITER WORK

The system allows you to set a speed to which your vehicle becomes limited. The set speed sets the effective maximum speed of your vehicle. You can temporarily exceed the set speed if required, for example to overtake.

The controls are on the steering wheel.

SPEED LIMITER PRECAUTIONS



WARNING: When you are going downhill, your vehicle speed could increase above the set speed. The system does not apply the brakes.



WARNING: You are responsible for controlling your vehicle at all times. The system is designed to be an aid and does not relieve you of your responsibility to drive with due care and attention. Failure to follow this instruction could result in the loss of control of your vehicle, personal injury or death.

SWITCHING THE SPEED LIMITER ON AND OFF

LIM

Press to set the system in standby mode. Press again to switch the system off.

SETTING THE SPEED LIMIT

SET+

Press the toggle button upward or downward with the system in standby mode to set the speed limiter to the current vehicle speed. The set speed is stored and displayed in the instrument

SET-

cluster display.

CHANGING THE SET SPEED LIMIT

SET+

You can adjust the set speed in small or large increments. Press the toggle button upward or downward once to adjust the set speed in small increments. Press and hold the toggle button

SET-

upward or downward to adjust the set speed in large increments.

CANCELING THE SET SPEED LIMIT



Press to cancel the set speed limiter. The system returns to standby mode.

Note: *The system does not limit the vehicle speed in standby mode.*

RESUMING THE SET SPEED LIMIT



Press to resume the set speed limiter.

Speed Limiter

INTENTIONALLY EXCEEDING THE SET SPEED LIMIT

Firmly press the accelerator pedal to temporarily exceed the set speed limit.

The system resumes when the vehicle speed drops below the set speed limit, or when you fully release the accelerator pedal for a short period of time.

If you intentionally exceed the set speed, a warning appears in the instrument cluster display.

SPEED LIMITER INDICATORS

 It illuminates in the instrument cluster display when you switch the system on.

It illuminates grey if the system is in standby mode.

SPEED LIMITER AUDIBLE WARNINGS

If you unintentionally exceed the set speed, for example when you are going downhill, a warning appears in the instrument cluster display and a tone sounds.

Intelligent Speed Limiter

WHAT IS THE INTELLIGENT SPEED LIMITER

Intelligent speed limiter is a driving aid that limits the vehicle speed to the maximum speed limit detected by the speed sign recognition system.

HOW DOES THE INTELLIGENT SPEED LIMITER WORK

The system allows you to limit the vehicle speed to the maximum speed limit detected by the speed sign recognition system. For example, if the speed sign recognition system detects a 50 mph (80 km/h) speed limit, the vehicle speed is limited to 50 mph (80 km/h). You can temporarily exceed the set speed if required, for example to overtake.

The controls are on the steering wheel.

A warning appears in the instrument cluster display if any of the following occur:

- The vehicle speed exceeds the current set speed.
- The system detects a maximum speed limit that is lower than the current vehicle speed.
- You intentionally exceed the set speed.
- You unintentionally exceed the set speed, for example when you are going downhill.

Note: *The system does not limit the vehicle speed to speed limits shown with a supplementary traffic sign in the instrument cluster display.*

INTELLIGENT SPEED LIMITER PRECAUTIONS



WARNING: When you are going downhill, your vehicle speed could increase above the set speed. The system does not apply the brakes.



WARNING: You are responsible for controlling your vehicle at all times. The system is designed to be an aid and does not relieve you of your responsibility to drive with due care and attention. Failure to follow this instruction could result in the loss of control of your vehicle, personal injury or death.

SWITCHING THE INTELLIGENT SPEED LIMITER ON AND OFF



Press to set the system in standby mode. The system prompts you to set a speed or show the detected speed limit as the set speed. Press again to switch the system off.

Note: *The system does not limit the vehicle speed in standby mode.*

SETTING THE SPEED LIMIT



Press the toggle button upward or downward with the system in standby mode to set the speed limiter to the current vehicle speed. The set speed is stored and displayed in the instrument cluster display.



Note: *The set speed limiter adjusts when the system detects a different maximum speed limit.*

Intelligent Speed Limiter

Note: If the system cannot detect a maximum speed limit, the system returns to standby mode.

CHANGING THE SET SPEED LIMIT

SET+ You can adjust the set speed in small or large increments. Press the toggle button upward or downward once to adjust the set speed in small increments. Press and hold the toggle button upward or downward to adjust the set speed in large increments.

ADJUSTING THE SPEED LIMIT TOLERANCE

You can set a permanent speed tolerance that is in addition to the detected speed limit.

1. Using the instrument cluster display controls on the steering wheel, select **Settings**.
2. Select **Driver Assistance**.
3. Select **Speed Limiter**.
4. Select **Intelligent**.
5. Select **Tolerance**.
6. Select a setting and press the **OK** button.

CANCELING THE SET SPEED LIMIT

 Press to cancel the speed limiter and set it in standby mode. The symbol in the instrument cluster display appears gray.

RESUMING THE SET SPEED LIMIT

 Press to resume the limiter. The system sets the speed limit to the detected maximum speed limit when it resumes. The symbol in instrument cluster display appears green.

INTENTIONALLY EXCEEDING THE SET SPEED LIMIT

Firmly press the accelerator pedal to temporarily exceed the set speed limit.

The system resumes when the vehicle speed drops below the set speed limit, or when you fully release the accelerator pedal for a short period of time.

If you intentionally exceed the set speed, a warning appears in the instrument cluster display.

INTELLIGENT SPEED LIMITER INDICATORS

 It illuminates in the instrument cluster display when you switch the system on.

It illuminates grey if the system is in standby mode.

Intelligent Speed Limiter

INTELLIGENT SPEED LIMITER AUDIBLE WARNINGS

A tone sounds if:

- You unintentionally exceed the set speed, for example when you are going downhill.
- You continue to exceed the set speed.
- The speed sign recognition system detects a speed limit outside the operational speed range, a tone sounds and the system returns to standby mode.

SWITCHING FROM INTELLIGENT SPEED LIMITER TO SPEED LIMITER

You can change between intelligent speed limiter and normal speed limiter using the instrument cluster display. Intelligent speed limiter allows you to limit the vehicle speed to the maximum speed limit detected by the speed sign recognition system. Normal speed limiter allows you to manually limit the vehicle speed using controls on the steering wheel.

1. Using the instrument cluster display controls on the steering wheel, select **Settings**.
2. Select **Driver Assistance**.
3. Select **Speed Limiter**.
4. Switch **Intelligent** off.

Note: *If you switch intelligent speed limiter off, the system defaults to manual speed limiter. You can manually set the speed limiter using the controls on the steering wheel.*

INTELLIGENT SPEED LIMITER – TROUBLESHOOTING

INTELLIGENT SPEED LIMITER – FREQUENTLY ASKED QUESTIONS

Why does a warning appear in the instrument cluster display?

- The vehicle speed exceeds the current set speed.
- The system detects a maximum speed limit that is lower than the current vehicle speed.
- You intentionally exceed the set speed.

Lane Keeping System

WHAT IS THE LANE KEEPING SYSTEM

The lane keeping system is a driving aid designed to provide temporary steering assistance or steering wheel vibration when it detects an unintended lane departure.

HOW DOES THE LANE KEEPING SYSTEM WORK

The system is designed to alert you by providing temporary steering assistance or steering wheel vibration when it detects an unintended lane departure. The system detects and tracks the road lane markings using a camera mounted behind the interior mirror. When you switch the system on, a graphic of lane markings appears in the instrument cluster display.



Note: *The system works when the camera can detect at least one lane marking.*

LANE KEEPING SYSTEM PRECAUTIONS

WARNING: You are responsible for controlling your vehicle at all times. The system is designed to be an aid and does not relieve you of your responsibility to drive with due care and attention. Failure to follow this instruction could result in the loss of control of your vehicle, personal injury or death.

WARNING: The system may not function if the sensor is blocked.

WARNING: The sensor may incorrectly track lane markings as other structures or objects. This can result in a false or missed warning.

WARNING: In cold and severe weather conditions the system may not function. Rain, snow and spray can all limit sensor performance.

WARNING: Large contrasts in outside lighting can limit sensor performance.

WARNING: The system will not operate if the sensor cannot track the road lane markings.

WARNING: If damage occurs in the immediate area surrounding the sensor, have your vehicle checked as soon as possible.

WARNING: The system may not correctly operate if your vehicle is fitted with a suspension kit not approved by us.

Lane Keeping System

LANE KEEPING SYSTEM LIMITATIONS

The system only operates when the vehicle speed is greater than approximately 37 mph (60 km/h).

The system may not correctly operate in any of the following conditions:

- The system does not detect at least one lane marking.
- You switch the direction indicator on.
- You apply direct steering, accelerate fast or brake hard.
- The vehicle speed is less than 37 mph (60 km/h).
- The anti-lock brake, stability control or traction control system activates.
- Narrow lane width.

The system may not correct lane positioning in any of the following conditions:

- High winds.
- Uneven road surfaces.
- Heavy or uneven loads.
- Incorrect tire pressure.

SWITCHING THE LANE KEEPING SYSTEM ON AND OFF



E270719

Press the button on the turn signal stalk.

SWITCHING THE LANE KEEPING SYSTEM MODE

1. Using the instrument cluster display controls on the steering wheel, select **Settings**.
2. Select **Driver Assistance**.
3. Select **Lane Keeping System**.
4. Select **Mode**.
5. Select a setting and press the **OK** button.

LANE KEEPING SYSTEM SETTINGS

You can select one of the three modes in the instrument cluster display:

- Alert mode.
- Aid mode.
- Alert and aid mode.

Lane Keeping System

Note: The system remembers the last mode when you start your vehicle. If the system detects a MyKey, the mode is set to alert.

ALERT MODE

WHAT IS ALERT MODE

Alert mode provides steering wheel vibration when it detects an unintended lane departure.

HOW DOES ALERT MODE WORK

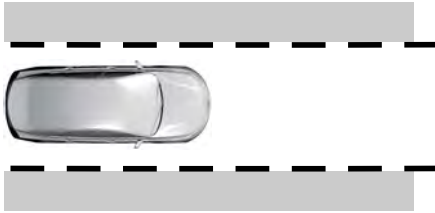

When in alert mode, the lane keeping system alerts you by vibrating the steering wheel if it detects an unintended lane departure.

ADJUSTING THE STEERING WHEEL VIBRATION INTENSITY

1. Using the instrument cluster display controls on the steering wheel, select **Settings**.
2. Select **Driver Assistance**.
3. Select **Lane Keeping System**.
4. Select **Intensity**.
5. Select a setting and press the **OK** button.

Note: This setting does not affect the aid mode.

AID MODE

WHAT IS AID MODE

Aid mode provides temporary steering assistance toward the center of the lane.

HOW DOES AID MODE WORK

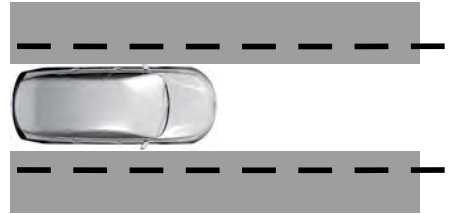

The lane keeping system aids you when an unintentional lane departure occurs. The system provides a small steering input to move your vehicle towards the center of the lane.

Note: When aid mode is on and the system does not detect any steering activity for a short period of time, for example lightly holding the steering wheel, the system alerts you to put your hands on the steering wheel.

Note: The aid mode becomes active again after you have returned your vehicle to the center of the lane.

Lane Keeping System

ALERT AND AID MODE

WHAT IS ALERT AND AID MODE

Alert and aid mode combines both, alert mode and aid mode.

HOW DOES ALERT AND AID MODE WORK

Alert and aid mode provides temporary steering assistance toward the lane center when the system detects an unintended lane departure. If your vehicle continues drifting out of the lane, the steering wheel vibrates.

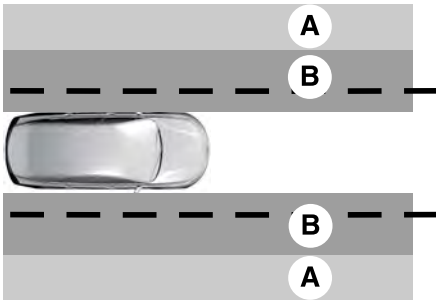

- A Alert.
- B Aid.

Note: The diagram illustrates general zone coverage. It does not provide exact zone parameters.

LANE KEEPING SYSTEM INDICATORS

 It illuminates in the instrument cluster display when you switch the system on and aid mode or alert and aid mode are selected.



It illuminates in the instrument cluster display when you switch the system on and alert mode is selected.

BLIND SPOT ASSIST - VEHICLES WITH: BLIND SPOT INFORMATION SYSTEM, VEHICLES WITHOUT: TRAILER TOW

WHAT IS BLIND SPOT ASSIST

Blind spot assist is an extension of the lane keeping system that provides a blind spot warning and steering assistance during lane changes if it detects adjacent vehicles.

HOW DOES BLIND SPOT ASSIST WORK



E270719

Activate and deactivate the system using the lane keeping system button on the turn signal stalk.

During lane changes, the design of the blind spot assist detects vehicles in, or approaching, your blind spot and provides a warning, plus steering assistance to direct your vehicle back into your lane.

Lane Keeping System

When active, this system functions with or without the use of turn signals and hazard flashers.

You must keep your hands on the steering wheel at all times.

BLIND SPOT ASSIST LIMITATIONS

All system limitations present in the basic lane keeping system also apply to blind spot assist.

Blind spot assist does not function under the following conditions:

- When none or only one of the two lane markings are detected.
- One or both rear radar sensors become blocked or faulty.
- A trailer is attached to your vehicle.

Note: *Bike carriers and cargo racks could cause false alerts due to obstruction of the sensor. We recommend switching the feature off when using a bike carrier or a cargo rack.*

Note: *The system does not recognize the trailer, if you attach a trailer without electrical connectors. We recommend to switch off blind spot assist if you attach a trailer without electrical connectors.*

Blind spot assist could have difficulty detecting hazards under the following conditions:

- If a vehicle is approaching in an adjacent lane at a relative speed much higher than your vehicle.
- Bad weather conditions are present that obstruct the sensors.

BLIND SPOT ASSIST INDICATORS

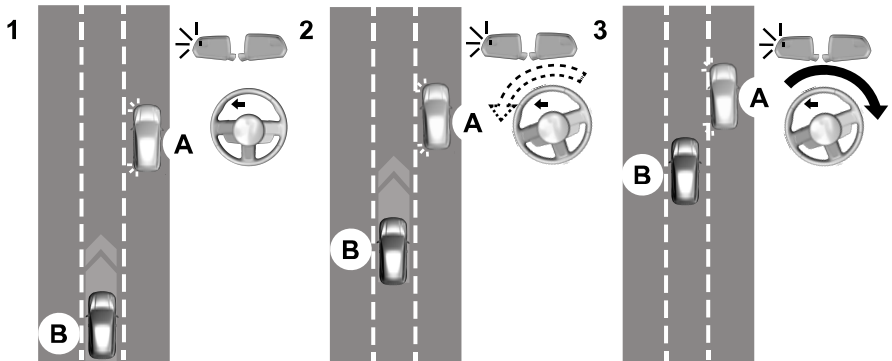

Diagram 1: Vehicle A uses its left turn signal preparing to change from the right lane to the middle lane. Vehicle B is already in the middle lane and just entered Vehicle A's blind spot causing the blind spot information system alert indicator to flash on the exterior mirror.

Diagram 2: The driver of Vehicle A begins to steer into the center lane not aware of Vehicle B.

Lane Keeping System

Diagram 3: Blind spot assist counter steers to help alert the driver of Vehicle A to direct their vehicle back into the right lane to help avoid a possible collision with Vehicle B.

The lane keeping aid warning lamp or yellow lane marking in your instrument cluster indicate blind spot assist activation. In addition, the blind spot information system alert indicator flashes on the exterior mirror on the same side as the detection. For more information See **Blind Spot Information System** (page 292).

BLIND SPOT ASSIST – INFORMATION MESSAGES

Message	Details
Blind Spot Assist Not Available Trailer Attached	Displays if you attach a trailer to your vehicle.
Blind Spot Assist Not Available Side Sensor Blocked	Displays if the blind spot information system sensors are blocked.
Blind Spot Assist System fault	The system has detected a fault that requires service. Have your vehicle checked as soon as possible.

BLIND SPOT ASSIST WITH TRAILER COVERAGE - VEHICLES WITH: BLIND SPOT INFORMATION SYSTEM/ TRAILER TOW

WHAT IS BLIND SPOT ASSIST WITH TRAILER COVERAGE

Blind spot assist with trailer coverage is an extension of the lane keeping system that provides a blind spot warning and steering assistance during lane changes if it detects adjacent vehicles.

Note: When attaching a trailer you must configure it so the system can recognize it. See **Blind Spot Information System With Trailer Coverage** (page 294).

HOW DOES BLIND SPOT ASSIST WITH TRAILER COVERAGE WORK



E270719

Activate and deactivate the system using the lane keeping system button on the turn signal stalk.

Lane Keeping System

During lane changes, the design of the blind spot assist with trailer coverage detects vehicles in, or approaching, your blind spot and provides a warning, plus steering assistance to direct your vehicle back into your lane.

If a supported trailer is connected, the function is reduced to only detecting vehicles on both sides of the vehicle and trailer, extending rearward from the exterior mirrors to the end of the trailer. See **Blind Spot Information System With Trailer Coverage** (page 294).

When active, this system functions with or without the use of turn signals and hazard flashers.

You must keep your hands on the steering wheel at all times.

BLIND SPOT ASSIST WITH TRAILER COVERAGE LIMITATIONS

All system limitations present in the basic lane keeping system also apply to blind spot assist with trailer coverage.

Blind spot assist with trailer coverage does not function under the following conditions:

- When none or only one of the two lane markings are detected.
- One or both rear radar sensors become blocked or faulty.
- The attached trailer is not correctly configured or it is not supported by the system. See **Blind Spot Information System With Trailer Coverage** (page 294).

Note: *Blind spot assist with trailer coverage could have reduced performance if you attach a trailer to your vehicle.*

Note: *The system does not recognize the trailer, if you attach a trailer without electrical connectors. We recommend to switch off blind spot assist with trailer coverage if you attach a trailer without electrical connectors.*

Blind spot assist with trailer coverage could have difficulty detecting hazards under the following conditions:

- If a vehicle is approaching in an adjacent lane at a relative speed much higher than your vehicle.
- Bad weather conditions are present that obstruct the sensors.
- Attaching bike carriers or cargo racks could cause false alerts due to obstruction of the sensor.

Lane Keeping System

BLIND SPOT ASSIST WITH TRAILER COVERAGE INDICATORS

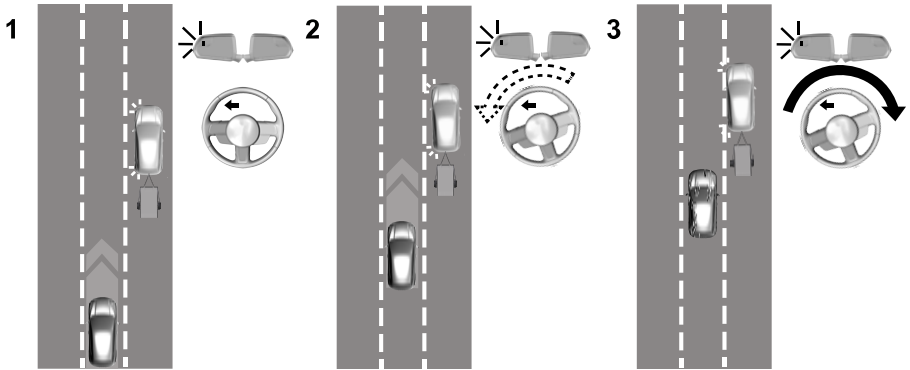

Diagram 1: Vehicle A uses its left turn signal preparing to change from the right lane to the middle lane. Vehicle B is already in the middle lane and just entered Vehicle A's blind spot causing the blind spot information system alert indicator to flash on the exterior mirror.

Diagram 2: The driver of Vehicle A begins to steer into the center lane not aware of Vehicle B.

Diagram 3: Blind spot assist counter steers to help alert the driver of Vehicle A to direct their vehicle back into the right lane to help avoid a possible collision with Vehicle B.

The lane keeping aid warning lamp or yellow lane marking in your instrument cluster indicate blind spot assist with trailer coverage activation. In addition, the blind spot information system alert indicator flashes on the exterior mirror on the same side as the detection. For more information See **Blind Spot Information System** (page 292).

Lane Keeping System

BLIND SPOT ASSIST WITH TRAILER COVERAGE – INFORMATION MESSAGES

Message	Details
Blind Spot Assist Not Available Trailer Attached	Displays if you attach a trailer wider than 7.9 ft (2.4 m), and the total length from the trailer hitch to the rear of the trailer is longer than 33 ft (10 m) to your vehicle. See Blind Spot Information System With Trailer Coverage (page 294).
Blind Spot Assist Not Available Side Sensor Blocked	Displays if the blind spot information system sensors are blocked.
Blind Spot Assist System fault	The system has detected a fault that requires service. Have your vehicle checked as soon as possible.

LANE KEEPING SYSTEM – TROUBLESHOOTING

LANE KEEPING SYSTEM – INFORMATION MESSAGES

Message	Details
Lane Keeping Sys. Malfunction Service Required	The system has detected a fault that requires service. Have your vehicle checked as soon as possible.
Front Camera Temporarily Not Available	The system has detected a condition that has caused the system to be temporarily unavailable.
Front Camera Low Visibility Clean Screen	The system has detected a condition that requires you to clean the windshield in order for it to operate properly.
Front Camera Malfunction Service Required	The system has detected a fault that requires service. Have your vehicle checked as soon as possible.
Keep Hands on Steering Wheel	The system requests that you keep your hands on the steering wheel.

Blind Spot Information System

WHAT IS BLIND SPOT INFORMATION SYSTEM

Blind spot information system is designed to detect vehicles that may have entered the blind spot zone.

HOW DOES BLIND SPOT INFORMATION SYSTEM WORK

The system is designed to detect vehicles that may have entered the blind spot zone. The detection area is on both sides of your vehicle, extending rearward from the exterior mirrors to approximately 13 ft (4 m) beyond the rear bumper. The detection area extends to approximately 59 ft (18 m) beyond the rear bumper when the vehicle speed is greater than 30 mph (48 km/h) to alert you of faster approaching vehicles.

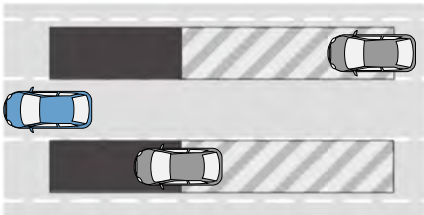

BLIND SPOT INFORMATION SYSTEM PRECAUTIONS

WARNING: Do not use the blind spot information system as a replacement for using the interior and exterior mirrors or looking over your shoulder before changing lanes. The blind spot information system is not a replacement for careful driving.

WARNING: The system may not operate properly during severe weather conditions, for example snow, ice, heavy rain and spray. Always drive with due care and attention. Failure to take care may result in a crash.

WARNING: If damage occurs in the immediate area surrounding the sensor, have your vehicle checked as soon as possible.

BLIND SPOT INFORMATION SYSTEM LIMITATIONS

The system does not operate in park (P) or reverse (R).

Note: The system does not prevent contact with other vehicles. It is not designed to detect parked vehicles, pedestrians, animals or other infrastructures.

Note: The system could not alert you if a vehicle quickly passes through the detection zone.

Note: Blocked sensors could affect system performance.

Blind Spot Information System

Note: The system may not correctly operate when towing a trailer. For vehicles with a trailer tow module and tow bar approved by us, the system turns off when you attach a trailer. For vehicles with an aftermarket trailer tow module or tow bar, we recommend that you switch the system off when you attach a trailer.

BLIND SPOT INFORMATION SYSTEM REQUIREMENTS

The system turns on when all of the following occur:

- You start your vehicle.
- You shift into drive (D).
- The vehicle speed is greater than 6 mph (10 km/h).

Note: The system does not operate in park (P) or reverse (R).

SWITCHING BLIND SPOT INFORMATION SYSTEM ON AND OFF

1. Using the instrument cluster display controls on the steering wheel, select **Settings**.
2. Select **Driver Assistance**.
3. Switch **Blind Spot** on or off.

If you switch the system off, a warning lamp illuminates and a message displays. When you switch the system on or off, the alert indicators flash twice.

Note: The system remembers the last setting when you start your vehicle.

To permanently switch the system off, contact an authorized dealer.

LOCATING THE BLIND SPOT INFORMATION SYSTEM SENSORS



The sensors are behind the rear bumper on both sides of your vehicle.

Note: Keep the sensors free from snow, ice and large accumulations of dirt.

Note: Do not cover the sensors with bumper stickers, repair compound or other objects.

Note: Blocked sensors could affect system performance.

If the sensors are blocked, a message may appear in the instrument cluster display. The alert indicators remain illuminated but the system does not alert you.

Blind Spot Information System

BLIND SPOT INFORMATION SYSTEM WITH TRAILER COVERAGE

WHAT IS BLIND SPOT INFORMATION SYSTEM WITH TRAILER COVERAGE

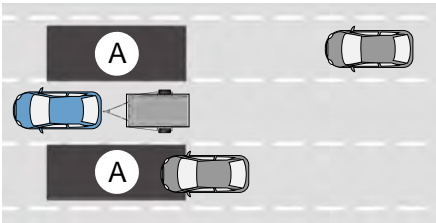

The blind spot information system with trailer coverage is designed to detect vehicles that could have entered the blind spot zone.

HOW DOES BLIND SPOT INFORMATION SYSTEM WITH TRAILER COVERAGE WORK

The blind spot information system with trailer coverage is designed to detect vehicles that could have entered the blind spot zone. The detection area is on both sides of your vehicle and trailer, extending rearward from the exterior mirrors to the end of your trailer. When you attach a trailer and have set up a trailer, the blind spot information system with trailer tow becomes active when driving forward above 6 mph (10 km/h).

You can set up the trailer length, select a trailer or switch blind spot information system with trailer tow off.

Note: *The system remembers the last trailer setting when you start your vehicle.*

BLIND SPOT INFORMATION SYSTEM WITH TRAILER COVERAGE LIMITATIONS

Some trailers may cause a slight change in system performance:

- Wide box trailers, especially those wider than the towing vehicle, may cause false alerts to occur when driving next to infrastructure or near parked cars. A false alert may also occur while making a 90-degree turn or driving through a roundabout.
- Wide trailers that have a total length greater than 20 ft (6 m) may cause delayed alerts when a vehicle is passing at high speed.
- Box trailers that have a width greater than 7.9 ft (2.4 m) may cause early alerts when you pass a vehicle.
- Clam shell or V-Nose box trailers with a width greater than 7.9 ft (2.4 m) may cause delayed alerts when a vehicle traveling the same speed as your vehicle merges lanes.

SWITCHING BLIND SPOT INFORMATION SYSTEM WITH TRAILER COVERAGE ON AND OFF

1. Using the information display controls on the steering wheel, select **Settings**.
2. Select **Driver Assistance**.
3. Select **Blind Spot**.
4. Select **Trailer**.
5. Select **None**.
6. Press the **OK** button.

When you switch the system off, a warning lamp illuminates and the alert indicators flash twice.

Blind Spot Information System

Note: The system turns off and a message appears when a trailer is connected, but not set up or selected.

SETTING A TRAILER LENGTH

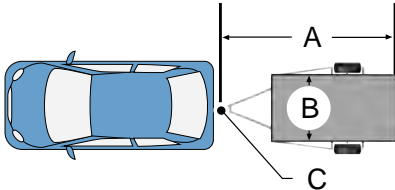

- A Trailer length.
- B Trailer width.
- C Trailer hitch.

The system operates only if the trailer front width is less than 7.9 ft (2.4 m), and the total length from the trailer hitch to the rear of the trailer is less than 33 ft (10 m).

1. Using the information display controls on the steering wheel, select **Settings**.
2. Select **Driver Assistance**.
3. Select **Blind Spot**.
4. Select **Trailer Lengths**.
5. Select **Trailer A**, **Trailer B** or **Trailer C**.
6. Select the trailer length at the closest available value.

Note: Proper measurement and measurement entry are required for the system to function as designed.

7. Press the **OK** button.

Note: If you attach load carriers such as bike racks or cargo racks with electrical lighting, enter a length of 3 ft (1 m). Cross Traffic Alert remains on.

SELECTING A TRAILER

If you select a trailer in the instrument cluster display prior to connecting a trailer, the system loads that configuration and an information message appears in the instrument cluster display when you connect the trailer.

1. Using the instrument cluster display controls on the steering wheel, select **Settings**.
2. Select **Driver Assistance**.
3. Select **Blind Spot**.
4. Select **Trailer**.
5. Select **Trailer A**, **Trailer B** or **Trailer C**.
6. Press the **OK** button.

BLIND SPOT INFORMATION SYSTEM INDICATORS



When the system detects a vehicle, an alert indicator illuminates in the exterior mirror on the side the approaching vehicle is coming from. If you turn the turn signals on for that side of your vehicle, the alert indicator flashes.

Note: The system could not alert you if a vehicle quickly passes through the detection zone.

BLIND SPOT INFORMATION SYSTEM – TROUBLESHOOTING

BLIND SPOT INFORMATION SYSTEM – WARNING LAMPS



If the system detects a fault, it illuminates in the instrument cluster and a message appears in the instrument cluster display. Have your vehicle checked as soon as possible.

Blind Spot Information System

BLIND SPOT INFORMATION SYSTEM – INFORMATION MESSAGES

Message	Details
Blind Spot not available Sensor blocked See manual	Displays if the blind spot information system sensors are blocked.
Blind Spot Alert Deactivated Trailer Attached	Displays if you attach a trailer to your vehicle.
Blind Spot System Fault	The system has detected a fault that requires service. Have your vehicle checked as soon as possible.

Note: *If you deactivate the blind spot information system but blind spot assist remains active the following messages are shown.*

Message	Details
Blind Spot Assist Not Available Trailer Attached	Displays if you attach a trailer to your vehicle.
Blind Spot Assist Not Available Side Sensor Blocked	Displays if the blind spot information system sensors are blocked.
Blind Spot Assist System fault	The system has detected a fault that requires service. Have your vehicle checked as soon as possible.

Cross Traffic Alert

WHAT IS CROSS TRAFFIC ALERT

The system is designed to alert you of vehicles approaching from the sides behind your vehicle when you shift into reverse (R).

HOW DOES CROSS TRAFFIC ALERT WORK

The system is designed to detect vehicles that approach at a speed between 5 mph (8 km/h) and 37 mph (60 km/h). Coverage decreases when the sensors are partially, mostly or fully obstructed. Slowly reversing helps increase the coverage area and effectiveness.

The system turns on when you start your vehicle and you shift into reverse (R). The system turns off when you shift out of reverse (R).

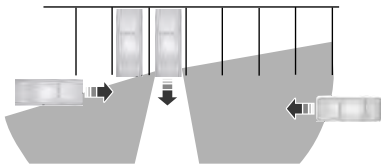

The sensor on the left-hand side is only partially obstructed and zone coverage on the right-hand side is maximized.

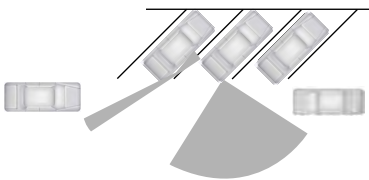

Zone coverage also decreases when parking at narrow angles. The sensor on the left-hand side is mostly obstructed and zone coverage on that side is severely reduced.

CROSS TRAFFIC ALERT PRECAUTIONS

WARNING: Do not use the cross traffic alert system as a replacement for using the interior and exterior mirrors or looking over your shoulder before reversing out of a parking space. The cross traffic alert system is not a replacement for careful driving.

WARNING: The system may not operate properly during severe weather conditions, for example snow, ice, heavy rain and spray. Always drive with due care and attention. Failure to take care may result in a crash.

WARNING: If damage occurs in the immediate area surrounding the sensor, have your vehicle checked as soon as possible.

CROSS TRAFFIC ALERT LIMITATIONS

The system may not correctly operate when any of the following occur:

- The sensors are blocked.
- Adjacently parked vehicles or objects are obstructing the sensors.
- Vehicles approach at speeds less than 5 mph (8 km/h) or greater than 37 mph (60 km/h).

Cross Traffic Alert

- Your vehicle speed is greater than 7 mph (12 km/h).
- You reverse out of an angled parking space.

Note: The system may not correctly operate when towing a trailer. For vehicles with a trailer tow module and tow bar approved by us, the system turns off when you attach a trailer. For vehicles with an aftermarket trailer tow module or tow bar, we recommend that you switch the system off when you attach a trailer.

SWITCHING CROSS TRAFFIC ALERT ON AND OFF

1. Using the instrument cluster display controls on the steering wheel, select **Settings**.
2. Select **Driver Assistance**.
3. Switch **Cross Traffic Alert** on or off.

Note: If you temporarily switch the system off, it turns on the next time you switch the ignition on.

To permanently switch the system off, contact an authorized dealer.

LOCATING THE CROSS TRAFFIC ALERT SENSORS



The sensors are behind the rear bumper on both sides of your vehicle.

Note: Keep the sensors free from snow, ice and large accumulations of dirt.

Note: Do not cover the sensors with bumper stickers, repair compound or other objects.

Note: Blocked sensors could affect system performance.

If the sensors are blocked, a message may appear in the instrument cluster display when you shift into reverse (R).

CROSS TRAFFIC ALERT WITH TRAILER COVERAGE

WHAT IS CROSS TRAFFIC ALERT WITH TRAILER COVERAGE

Cross traffic alert with trailer coverage allows the system to continue operating with a trailer or trailer hitch attachment.

CROSS TRAFFIC ALERT WITH TRAILER COVERAGE LIMITATIONS

Cross traffic alert remains on when you attach a trailer in vehicles that come with blind spot information system with trailer coverage under the following conditions:

- You connect a trailer.
- The trailer is a bike rack or cargo rack with a maximum length of 3 ft (1 m).
- You set the trailer length to 3 ft (1 m) in the center display.

Note: The system may not correctly operate when towing a trailer. For vehicles with an approved trailer tow module and tow bar, the system turns off when you attach a trailer. For vehicles with an aftermarket trailer tow module or tow bar, we recommend that you switch the system off when you attach a trailer.

Cross Traffic Alert

CROSS TRAFFIC ALERT INDICATORS



When the system detects an approaching vehicle a tone sounds, an indicator illuminates in the relevant exterior mirror and direction indicators appear in the center display to show which side the approaching vehicle is coming from.

Note: If the direction indicators do not display, a message appears in the instrument cluster display.

Note: In exceptional conditions, the system could alert you even when there is nothing in the detection zone, for example a vehicle passing further away from your vehicle.

CROSS TRAFFIC ALERT – TROUBLESHOOTING

CROSS TRAFFIC ALERT – WARNING LAMPS



If the system malfunctions, it illuminates in the instrument cluster and a message appears in the instrument cluster display. Have your vehicle checked as soon as possible.

CROSS TRAFFIC ALERT – INFORMATION MESSAGES

Message	Details
Cross Traffic Alert	Displays instead of direction indicators when the system detects a vehicle. Check for approaching traffic.
Cross Traffic Not Available Sensor Blocked See Manual	Displays if the cross traffic alert system sensors are blocked. Clean the sensors. If the message continues to appear, have your vehicle checked as soon as possible.
Cross Traffic System Fault	The system has malfunctioned. Have your vehicle checked as soon as possible.
Cross Traffic Alert Deactivated Trailer Attached	Displays if you attach a trailer to your vehicle.

Pre-Collision Assist

WHAT IS PRE-COLLISION ASSIST

Pre-collision assist detects other road users and warns you of their presence. If you do not respond, the system automatically applies the brakes.

HOW DOES PRE-COLLISION ASSIST WORK

The pre-collision assist system is active when your vehicle reaches a speed greater than approximately 6 mph (10 km/h). Pedestrian and cyclist detection is active at speeds up to 50 mph (80 km/h).



If your vehicle is rapidly approaching another stationary vehicle, a vehicle traveling in the same direction as yours, a pedestrian or a cyclist within your driving path, the system is designed to provide three levels of functionality.

Level of Functionality	Details
Alert	When activated, a warning lamp flashes and an audible warning sounds.
Brake support	The system is designed to help reduce the impact speed by preparing the brakes for rapid braking. The system does not automatically apply the brakes. If you press the brake pedal, the system could apply additional braking up to maximum braking force, even if you lightly press the brake pedal.
Automatic emergency braking - vehicles without adaptive cruise control	The system is designed to apply the brakes if it detects a crash is imminent. This may help reduce impact or avoid the crash. The system is active at speeds up to 80 mph (130 km/h).
Automatic emergency braking - vehicles with adaptive cruise control	The system is designed to apply the brakes if it detects a crash is imminent. This may help reduce impact or avoid the crash.

Pre-Collision Assist

HOW DOES PRE-COLLISION ASSIST WITH INTERSECTION ASSIST WORK

The pre-collision assist system could apply brakes if you are turning across an oncoming vehicle's path. Detection of vehicles driving in an oncoming direction is active if your vehicle is driving at speeds up to 19 mph (30 km/h).

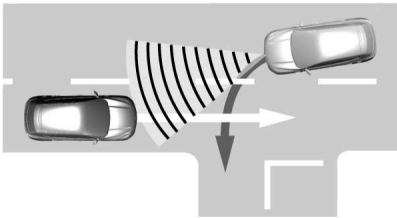

PRE-COLLISION ASSIST PRECAUTIONS

WARNING: You are responsible for controlling your vehicle at all times. The system is designed to be an aid and does not relieve you of your responsibility to drive with due care and attention. Failure to follow this instruction could result in the loss of control of your vehicle, personal injury or death.

WARNING: The system does not operate during hard acceleration or steering. Failure to take care may lead to a crash or personal injury.

WARNING: The system may operate with reduced function during cold and inclement weather conditions. Snow, ice, rain, spray and fog can adversely affect the system. Keep the front camera and radar free of snow and ice. Failure to follow this instruction may result in the loss of control of your vehicle, serious personal injury or death.

WARNING: The system may not operate properly if your vehicle has a non-Ford windshield. Do not carry out windshield repairs in the area around the sensor.

WARNING: System performance could be reduced in situations where the vehicle camera has limited detection capability. These situations include but are not limited to direct or low sunlight, vehicles at night without tail lights, unconventional vehicle types, pedestrians or cyclists with complex backgrounds, running pedestrians or fast moving cyclists, partly obscured pedestrians or cyclists, pedestrians or cyclists that the system cannot distinguish from a group. Failure to take care may result in the loss of control of your vehicle, personal injury or death.

WARNING: The Pre-Collision Assist system with brake support cannot help prevent all collisions. Do not rely on this system to replace your judgment and the need to maintain correct distance and speed.

PRE-COLLISION ASSIST LIMITATIONS

The system is not designed to detect animals.

Pre-Collision Assist

The system is not designed to detect vehicles that are traveling in a different direction.

LOCATING THE PRE-COLLISION ASSIST SENSORS - VEHICLES WITHOUT: ADAPTIVE CRUISE CONTROL



The camera is mounted behind the interior mirror.

Note: Keep the sensors free from snow, ice and large accumulations of dirt.

Note: Do not clean the sensors with sharp objects.

Note: If your vehicle sustains damage leaving the sensors misaligned, this may cause inaccurate measurements or false alerts.

Blocked sensors could affect system accuracy. A message could appear in the instrument cluster display.

LOCATING THE PRE-COLLISION ASSIST SENSORS - VEHICLES WITH: ADAPTIVE CRUISE CONTROL



The camera is mounted behind the interior mirror.

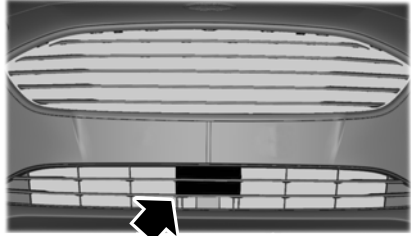

The radar sensor is behind the front grille below the license plate.

Note: Keep the sensors free from snow, ice and large accumulations of dirt.

Note: Do not clean the sensors with sharp objects.

Note: If your vehicle sustains damage leaving the sensors misaligned, this may cause inaccurate measurements or false alerts.

Pre-Collision Assist

Blocked sensors could affect system accuracy. A message could appear in the instrument cluster display.

Note: *The graphic does not display if you switch on cruise control or adaptive cruise control.*

DISTANCE INDICATION

WHAT IS DISTANCE INDICATION

Distance indication displays in the instrument cluster display the time gap to vehicles ahead of you traveling in the same direction.

SWITCHING DISTANCE INDICATION ON AND OFF

1. Using the instrument cluster display controls on the steering wheel, select **Settings**.
2. Select **Driver Assistance**.
3. Select **Pre-Collision Assist**.
4. Switch **Distance Indication** on or off.

DISTANCE INDICATION INDICATOR

Vehicle Speed	System Sensitivity	Distance Indicator Color	Distance Gap	Time Gap
62 mph (100 km/h)	Normal.	Gray.	Greater than 82.0 ft (25 m).	Greater than 0.9 seconds.
		Yellow.	55.8–82.0 ft (17–25 m).	0.6–0.9 seconds.
		Red.	Less than 55.8 ft (17 m).	Less than 0.6 seconds.

FORWARD COLLISION WARNING

WHAT IS FORWARD COLLISION WARNING

A warning flashes and an audible warning sounds if your vehicle rapidly approaches another vehicle, to warn you of the risk of a crash with the vehicle in front of you.

ADJUSTING THE SENSITIVITY OF FORWARD COLLISION WARNING

1. Using the instrument cluster display controls on the steering wheel, select **Settings**.
2. Select **Driver Assistance**.
3. Select **Pre-Collision Assist**.
4. Select **Alert Sensitivity**.
5. Select a setting and press the **OK** button.

Pre-Collision Assist

DISTANCE ALERT

WHAT IS DISTANCE ALERT

A warning lamp illuminates if the distance to the vehicle ahead is small.

Note: *The warning lamp does not illuminate if cruise control or adaptive cruise control is active.*

ADJUSTING THE SENSITIVITY OF DISTANCE ALERT

1. Using the instrument cluster display controls on the steering wheel, select **Settings**.
2. Select **Driver Assistance**.
3. Select **Pre-Collision Assist**.
4. Select **Alert Sensitivity**.
5. Select a setting and press the **OK** button.

AUTOMATIC EMERGENCY BRAKING

WHAT IS AUTOMATIC EMERGENCY BRAKING

Automatic emergency braking is an active safety system that activates the vehicle brakes when a potential crash is detected.

PRE-COLLISION ASSIST – INFORMATION MESSAGES

Message	Details
Pre-Collision Assist Not Available	The system has malfunctioned. Have your vehicle checked as soon as possible.
Pre-Collision Assist Not Available Sensor Blocked	The sensors are dirty. Clean the sensors. Check the list of possible causes and actions in the table below. If the message continues to appear, have your vehicle checked as soon as possible.

SWITCHING AUTOMATIC EMERGENCY BRAKING ON AND OFF

1. Using the instrument cluster display controls on the steering wheel, select **Settings**.
2. Select **Driver Assistance**.
3. Select **Pre-Collision Assist**.
4. Switch **Active Braking** on or off.

PRE-COLLISION ASSIST – TROUBLESHOOTING

PRE-COLLISION ASSIST – WARNING LAMPS



It illuminates if your vehicle rapidly approaches another vehicle, to warn you of the risk of a crash with the vehicle in front of you.

It could illuminate red if the distance to the vehicle ahead is small.

It illuminates amber when you switch the system off or if the system is not available.

Pre-Collision Assist

The following table lists possible causes and actions for when a blocked sensor message could display.

Cause	Details
The surface of the radar in the radiator grille is dirty or obstructed.	Clean the radiator grille in front of the radar or remove any obstruction.
The surface of the radar is clean but the message remains in the display.	Wait for a short period of time. It may take several minutes for the system to detect that there is no obstruction.
Heavy rain, spray, snow, or fog is interfering with the radar signals.	The system is temporarily disabled. The system should reactivate after a short period of time when the weather conditions improve.
The radar is misaligned.	Have your vehicle checked as soon as possible.
The windshield in front of the camera is dirty or obstructed.	Clean the outside of the windshield in front of the camera.
The windshield in front of the camera is clean but the message remains in the display.	Wait for a short period of time. It may take several minutes for the camera to detect that there is no obstruction.
Excessive heat around the camera.	Wait for a short period of time. The message should clear when the temperature around the camera decreases.

Speed Sign Recognition

WHAT IS SPEED SIGN RECOGNITION

The system is designed to detect speed limit signs to inform you of the current speed limit.

HOW DOES SPEED SIGN RECOGNITION WORK

Detected speed signs appear in the instrument cluster display. The sensor is behind the interior mirror.

The system turns on when you switch the ignition on and you cannot switch the system off.

Note: Speed sign data provided by the navigation system contains information integrated to the data carrier release.

SPEED SIGN RECOGNITION PRECAUTIONS



WARNING: You are responsible for controlling your vehicle at all times. The system is designed to be an aid and does not relieve you of your responsibility to drive with due care and attention. Failure to follow this instruction could result in the loss of control of your vehicle, personal injury or death.



WARNING: The system may not operate properly if the sensor is blocked. Keep the windshield free from obstruction.

Note: Do not carry out windshield repairs in the immediate area surrounding the sensor.

Note: Always fit Ford approved parts when replacing headlamp bulbs. Other bulbs could reduce system performance.

SPEED SIGN RECOGNITION LIMITATIONS

The system could not detect all speed signs and could incorrectly read signs.

In cold and severe weather conditions the system could not function. Rain, snow, spray and large contrasts in lighting can all prevent the sensor from correctly functioning.

If your vehicle has a suspension kit not approved by us, the system could not correctly function.

SPEED SIGN RECOGNITION INDICATORS



When the system detects a speed limit sign, the speed limit appears in the instrument cluster display.

Note: If your vehicle has a navigation system, stored speed sign data could influence the indicated speed limit value.

Speed Sign Recognition

SETTING THE SPEED SIGN RECOGNITION SPEED WARNING

1. Using the instrument cluster display controls on the steering wheel, select **Settings**.
2. Select **Driver Assistance**.
3. Select **Traffic Sign Recognition**.
4. Select **Activate TSR**.
5. Select **Activate Speed Warning**.
6. Switch **Overspeed Chime** on or off.

SETTING THE SPEED SIGN RECOGNITION SPEED TOLERANCE

You can set the system speed warning to alert you when the vehicle speed exceeds the speed limit recognized by the system by a certain speed tolerance.

1. Using the instrument cluster display controls on the steering wheel, select **Settings**.
2. Select **Driver Assistance**.
3. Select **Traffic Sign Recognition**.
4. Select **Activate TSR**.
5. Select **Activate Speed Warning**.
6. Select **Speed Warning**.
7. Select a setting and press the **OK** button.

Note: *The system remembers the last setting when you start your vehicle.*

SPEED SIGN RECOGNITION – TROUBLESHOOTING

SPEED SIGN RECOGNITION – INFORMATION MESSAGES

Message	Action
Traffic Sign Reduced Performance See Manual	The traffic sign data provided by the navigation system is unavailable due to weak or no signal. Wait for a short period of time for the signal to improve. If the message continues to appear, have your vehicle checked as soon as possible.

Driver Alert

WHAT IS DRIVER ALERT

The system is designed to alert you if it calculates that you are becoming drowsy or if your driving deteriorates.

HOW DOES DRIVER ALERT WORK

The system calculates your alertness level based upon your driving behavior in relation to the lane markings and other factors when the vehicle speed is greater than approximately 40 mph (65 km/h).

The warning system has two stages:

1. A temporary warning is issued to advise you to take a rest. This message only appears for a short time.
2. If you do not rest and the system continues to detect that your driving deteriorates, it issues a further warning. This remains in the instrument cluster display until you cancel it.

DRIVER ALERT PRECAUTIONS



WARNING: You are responsible for controlling your vehicle at all times. The system is designed to be an aid and does not relieve you of your responsibility to drive with due care and attention. Failure to follow this instruction could result in the loss of control of your vehicle, personal injury or death.



WARNING: The system may not operate properly if the sensor is blocked. Keep the windshield free from obstruction.



WARNING: Take regular rest breaks if you feel tired. Do not wait for the system to warn you.



WARNING: Certain driving styles may result in the system warning you even if you are not feeling tired.



WARNING: In cold and severe weather conditions the system may not function. Rain, snow and spray can all limit sensor performance.



WARNING: The system will not operate if the sensor cannot track the road lane markings.



WARNING: If damage occurs in the immediate area surrounding the sensor, have your vehicle checked as soon as possible.



WARNING: The system may not correctly operate if your vehicle is fitted with a suspension kit not approved by us.

SWITCHING DRIVER ALERT ON AND OFF

1. Using the instrument cluster display controls on the steering wheel, select **Settings**.
2. Select **Driver Assistance**.
3. Switch **Driver Alert** on or off.

Note: *The system remains on or off depending on how it was last set.*

RESETTING DRIVER ALERT

You can reset driver alert by:

- Switching the ignition off and on when your vehicle is stationary.
- Opening and closing the driver door when your vehicle is stationary.

Driver Alert

DRIVER ALERT – TROUBLESHOOTING

DRIVER ALERT – INFORMATION MESSAGES

Message	Details
Driver Alert Warning Rest Suggested	Displays when we recommend that you take a break due to low alertness levels.
Driver Alert Warning Rest Now	Displays when you must take a break due to low alertness levels.
Front Camera Low Visibility Clean Screen	The system has detected a condition that requires you to clean the windshield in order for it to operate properly.

Note: *Depending on your vehicle options and region not all messages are available.*

Load Carrying

LOAD CARRYING PRECAUTIONS

Keep your loaded vehicle weight within its design rating capability, with or without a trailer. Properly loading your vehicle provides maximum return of vehicle design performance. Before you load your vehicle, become familiar with the following terms for determining your vehicle's weight rating, with or without a trailer, from the vehicle's Tire and Loading Information label or Safety Compliance Certification label.



WARNING: The appropriate loading capacity of your vehicle can be limited either by volume capacity (how much space is available) or by payload capacity (how much weight the vehicle should carry). Once you have reached the maximum payload of your vehicle, do not add more cargo, even if there is space available. Overloading or improperly loading your vehicle can contribute to loss of vehicle control and vehicle rollover.



WARNING: Exceeding the Safety Compliance Certification label vehicle weight limits can adversely affect the performance and handling of your vehicle, cause vehicle damage and can result in the loss of control of your vehicle, serious personal injury or death.



WARNING: Do not use replacement tires with lower load carrying capacities than the original tires because they may lower your vehicle's GVWR and GAWR limitations. Replacement tires with a higher limit than the original tires do not increase the GVWR and GAWR limitations.



WARNING: Do not exceed the GVWR or the GAWR specified on the certification label.



WARNING: Exceeding any vehicle weight rating can adversely affect the performance and handling of your vehicle, cause vehicle damage and can result in the loss of control of your vehicle, serious personal injury or death.



WARNING: When loading the roof racks, we recommend you evenly distribute the load, as well as maintain a low center of gravity. Loaded vehicles, with higher centers of gravity, may

Load Carrying

handle differently than unloaded vehicles. Take extra precautions, such as slower speeds and increased stopping distance, when driving a heavily loaded vehicle.

The gross combined weight must never exceed the Gross Combined Weight Rating.

LOCATING THE SAFETY COMPLIANCE CERTIFICATION LABELS

Safety Compliance Certification Label Example:

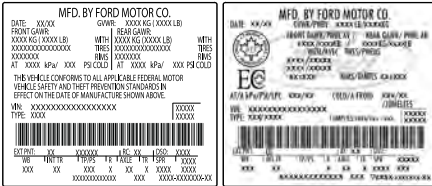

The Safety Compliance Certification label is located on the door hinge pillar, door-latch post, or the door edge that meets the door-latch post, next to the driver seating position.

WHAT IS THE GROSS AXLE WEIGHT RATING

GAWR (Gross Axle Weight Rating)

GAWR is the maximum allowable weight that a single axle (front or rear) can carry. These numbers are on the Safety Compliance Certification label.

WHAT IS THE GROSS VEHICLE WEIGHT RATING

GVWR is the maximum allowable weight of the fully loaded vehicle. This includes all options, equipment, passengers and cargo. It appears on the Safety Compliance Certification label.

WHAT IS THE GROSS COMBINED WEIGHT RATING

Gross Combined Weight Rating (GCWR) is the maximum allowable weight of the vehicle and the loaded trailer, including all cargo and passengers, that the vehicle can handle without risking damage. (Important: The towing vehicle's braking system is rated for operation at Gross Vehicle Weight Rating, not at Gross Combined Weight Rating.) Separate functional brakes should be used for safe control of towed vehicles and for trailers where the

Load Carrying

Gross Combined Weight of the towing vehicle plus the trailer exceed the Gross Vehicle Weight Rating of the towing vehicle. See **Recommended Towing Weights** (page 322).

CALCULATING PAYLOAD

Tire and Loading Label Information Example:



TIRE AND LOADING INFORMATION

SEATING CAPACITY	TOTAL : 5	FRONT: 2	REAR: 3
------------------	-----------	----------	---------

The combined weight of occupants, and cargo should never exceed: **385 kg or 850 lbs.**

TIRE	SIZE	COLD TIRE PRESSURE
FRONT	235/45R18 94V	235 KPA, 34 PSI
REAR	235/45R18 94V	235 KPA, 34 PSI
SPARE	NONE	NONE

SEE OWNERS MANUAL FOR ADDITIONAL INFORMATION

exported outside the US and Canada may not have a tire and loading label. Look for "The combined weight of occupants and cargo should never exceed XXX kg or XXX lb" for maximum payload. The payload listed on the Tire and Loading Information label is the maximum payload for your vehicle as built by the assembly plant. If you install any additional equipment on your vehicle, you must determine the new payload. Subtract the weight of the equipment from the payload listed on the Tire and Loading label. When towing, trailer tongue weight or king pin weight is also part of payload.

CALCULATING THE LOAD LIMIT

Steps for determining the correct load limit:

1. Locate the statement "The combined weight of occupants and cargo should never exceed XXX kg or XXX lb." on your vehicle's placard.
2. Determine the combined weight of the driver and passengers that will be riding in your vehicle.
3. Subtract the combined weight of the driver and passengers from XXX kg or XXX lb.



TIRE AND LOADING INFORMATION
RENSEIGNEMENTS SUR LES PNEUS ET LE CHARGEMENT

SEATING CAPACITY	TOTAL : 5	FRONT	2	REAR	3
NOMBRE DE PLACES		AVANT		ARRIERE	

The combined weight of occupants and cargo should never exceed **396 kg or 875 lbs.**
Le poids total des occupants et du chargement ne doit jamais dépasser **396 kg ou 875 lbs.**

TIRE PNEU	SIZE DIMENSIONS	COLD TIRE PRESSURE
		PRESSION DES PNEUS A FROID
FRONT AVANT	235/40R19 96V	255 KPA, 37 PSI
REAR ARRIERE	235/40R19 96V	255 KPA, 37 PSI
SPARE DE SECOURS	T125/80R16 97M	415 KPA, 60 PSI

SEE OWNER'S MANUAL FOR ADDITIONAL INFORMATION
VOIR LE MANUEL DE L'USAGER POUR PLUS DE RENSEIGNEMENTS

Payload is the combined weight of cargo and passengers that your vehicle is carrying. The maximum payload for your vehicle appears on the Tire and Loading label. The label is either on the B-pillar or the edge of the driver door. Vehicles

Load Carrying

- The resulting figure equals the available amount of cargo and luggage load capacity. For example, if the “XXX” amount equals 1,400 lb. and there will be five 150 lb. passengers in your vehicle, the amount of available cargo and luggage load capacity is 650 lb. $(1400 - 750) (5 \times 150) = 650 \text{ lb.}$
- Determine the combined weight of luggage and cargo being loaded on the vehicle. That weight may not safely exceed the available cargo and luggage load capacity calculated in Step 4.
- If your vehicle will be towing a trailer, load from your trailer will be transferred to your vehicle. Consult this manual to determine how this reduces the available cargo and luggage load capacity of your vehicle.

Helpful examples for calculating the available amount of cargo and luggage load capacity

Suppose your vehicle has a 1400-pound (635-kilogram) cargo and luggage capacity. You decide to go golfing. Is there enough load capacity to carry you, four of your friends and all the golf bags? You and four friends average 220 pounds (99 kilograms) each and the golf bags weigh approximately 30 pounds (13.5 kilograms) each. The calculation would be: $1400 - (5 \times 220) - (5 \times 30) = 1400 - 1100$

$- 150 = 150$ pounds. Yes, you have enough load capacity in your vehicle to transport four friends and your golf bags. In metric units, the calculation would be: $635 \text{ kilograms} - (5 \times 99 \text{ kilograms}) - (5 \times 13.5 \text{ kilograms}) = 635 - 495 - 67.5 = 72.5 \text{ kilograms.}$

Suppose your vehicle has a 1400-pound (635-kilogram) cargo and luggage capacity. You and one of your friends decide to pick up cement from the local home improvement store to finish that patio you have been planning for the past two years. Measuring the inside of the vehicle with the rear seat folded down, you have room for twelve 100-pound (45-kilogram) bags of cement. Do you have enough load capacity to transport the cement to your home? If you and your friend each weigh 220 pounds (99 kilograms), the calculation would be: $1400 - (2 \times 220) - (12 \times 100) = 1400 - 440 - 1200 = -240$ pounds. No, you do not have enough cargo capacity to carry that much weight. In metric units, the calculation would be: $635 \text{ kilograms} - (2 \times 99 \text{ kilograms}) - (12 \times 45 \text{ kilograms}) = 635 - 198 - 540 = -103 \text{ kilograms.}$ You will need to reduce the load weight by at least 240 pounds (104 kilograms). If you remove three 100-pound (45-kilogram) cement bags, then the load calculation would be: $1400 - (2 \times 220) - (9 \times 100) = 1400 - 440 - 900 = 60$ pounds. Now you have

Load Carrying

the load capacity to transport the cement and your friend home. In metric units, the calculation would be: 635 kilograms - (2 x 99 kilograms) - (9 x 45 kilograms) = 635 - 198 - 405 = 32 kilograms.

The above calculations also assume that the loads are positioned in your vehicle in a manner that does not overload the front or the rear gross axle weight rating specified for your vehicle on the Safety Compliance Certification label.

ROOF RACK

ROOF RACK PRECAUTIONS - BUS



WARNING: Your vehicle is not approved for roof racks. Never install a roof rack to your vehicle.

ROOF RACK PRECAUTIONS - VAN



WARNING: Read and follow the manufacturer's instructions when you are fitting a roof rack.



WARNING: When loading the roof racks, we recommend you evenly distribute the load, as well as maintain a low center of gravity. Loaded vehicles, with higher centers of gravity, may handle differently than unloaded vehicles. Take extra precautions, such as slower speeds and increased stopping distance, when driving a heavily loaded vehicle.

Note: If you use a roof rack, the fuel consumption of your vehicle will be higher and you may experience different driving characteristics.

Note: Never place loads directly on the roof panel. The roof panel is not designed to directly carry a load.

You must place loads directly on the crossbars fitted to the roof rack side rails. When using the roof rack system, we recommend that you use genuine Ford accessory crossbars specifically designed for your vehicle.

Make sure that you securely fasten the load. Check the tightness of the load before driving and at each fuel stop.

ROOF RACK LOAD CAPACITIES - VAN

Maximum Roof Load

Variant	lb (kg)
Low Roof.	419 (190)
Medium Roof.	331 (150)
High Roof.	220 (100)

Rear Cargo Area

REAR CARGO AREA ANCHOR POINTS

REAR CARGO AREA ANCHOR POINT PRECAUTIONS

WARNING: Always properly secure cargo to prevent shifting cargo or cargo falling from the vehicle. Failure to do so could result in compromised vehicle stability and serious personal injury to vehicle occupants or others.

WARNING: The appropriate loading capacity of your vehicle can be limited either by volume capacity (how much space is available) or by payload capacity (how much weight the vehicle should carry). Once you have reached the maximum payload of your vehicle, do not add more cargo, even if there is space available. Overloading or improperly loading your vehicle can contribute to loss of vehicle control and vehicle rollover.

WARNING: Do not exceed the maximum load rating of the load retaining fixtures. Failure to follow this instruction could result in personal injury.

WARNING: Check the load retaining fixtures for damage before using them. Failure to follow this instruction could result in personal injury.

WARNING: Do not use the load retaining fixtures for towing. Failure to follow this instruction could result in personal injury.

LOCATING THE REAR CARGO AREA ANCHOR POINTS

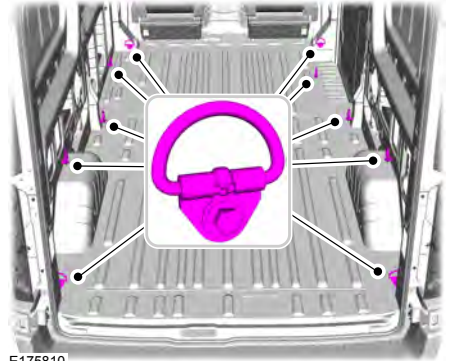

E175810

Note: The number of load retaining fixtures could vary depending on your vehicle model.

REAR CARGO AREA ANCHOR POINT LOAD CAPACITIES

Variant	Maximum Load Value
All Van	1,125 lb (5,000 N)

Connecting a Trailer

CONNECTING A TRAILER PRECAUTIONS

Do not tow a trailer until you drive your vehicle at least 1,000 mi (1,600 km).

Consult your local motor vehicle laws for towing a trailer.

See the instructions included with towing accessories for the proper installation and adjustment specifications.

Service your vehicle more frequently if you tow a trailer. See **Normal Scheduled Maintenance** (page 530).

If you use a rental trailer, follow the instructions the rental agency gives you.

When attaching the trailer wiring connector to your vehicle, only use a proper fitting connector that works with the vehicle and trailer functions.

Account for the trailer coupler weight as part of your vehicle load when calculating the total vehicle weight.

Do not exceed the load limits. See **Calculating the Load Limit** (page 312).

CONNECTING A TRAILER

1. Attach the trailer and wiring connector to your vehicle.
2. Switch on your vehicle.
3. Set up the trailer brake controller using the instrument cluster display.

Note: *If your vehicle does not recognize the trailer, press and hold the brake pedal for a few seconds.*



When attaching the trailer wiring connector to your vehicle, only use a proper fitting connector that works with the vehicle and trailer functions.

Safety Chains

Install trailer safety chains to the trailer hitch as recommended by the manufacturer. Cross the chains under the trailer coupler and allow enough slack for turning tight corners. Do not allow the chains to drag on the ground.

Note: *Do not attach safety chains to the bumper. Always connect the safety chains to the frame or hook retainers of your trailer hitch.*

Connecting a Trailer

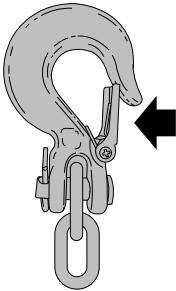

If the trailer safety chain hook has a latch, make sure the latch is fully closed.

Trailer Connection Checklist

1. Press **Features** on the touchscreen.
2. Press **Towing**.
3. Press **Connection Checklist**.

Trailer Light Check



WARNING: Never connect any trailer lamp wiring to the vehicle's tail lamp wiring; this may damage the electrical system resulting in fire. Contact your authorized dealer as soon as possible for assistance in proper trailer tow wiring installation. Additional electrical equipment may be required.

Perform a trailer light illumination sequence to confirm that all lights are functioning by using the FordPass app.

Note: The FordPass app allows one person to confirm that all lights are functioning.

Electronic Park Hold



Applies the electronic parking brake when you shift to park (P).

The electronic park hold button illuminates when activated.

The feature prevents your vehicle from moving in any direction when you are aligned with your trailer coupler and shift to park (P).

Note: The feature is active for the current key cycle.

You can also press a zoom button when using the camera views to switch the feature on.

Trailer Connection Alarm

The alarm is set when the following occur:

- Your vehicle detects the trailer.
- Your vehicle is locked.
- The alarm is armed.

When the trailer is disconnected in this state, the vehicle alarm sounds and an alert is sent to your FordPass app.

Note: For reliable trailer detection, the trailer's lamps must be SAE certified for each intended purpose.

Note: If the trailer is not compatible with the feature, the turn signals flash twice.

Connecting a Trailer

CONNECTING A TRAILER – TROUBLESHOOTING

CONNECTING A TRAILER – INFORMATION MESSAGES

Message	Description
Trailer Disconnected	The system senses a trailer connection becomes disconnected, either intentionally or unintentionally, during a given ignition cycle.
Trailer Wiring Fault	There are certain faults in your vehicle wiring and trailer wiring or brake system.
Trailer Battery Not Charging See Manual	The vehicle battery voltage is low, there is a fault with your trailer battery, your trailer battery voltage is below 8V or your trailer battery is connected in reverse polarity
Trailer Tire Low Specified:	One or more tires on your trailer is below the specified tire pressure.
Trailer Tire Over Temperature	Displays when one or more tires on the trailer is above the recommended temperature.
Trailer Tire Pressure Sensor Fault	A trailer tire pressure sensor is malfunctioning. If the warning stays on or continues to come on, have the system checked as soon as possible.
Trailer Tire Pressure Monitor Fault	The trailer tire pressure monitoring system is malfunctioning. If the warning stays on or continues to come on, have the system checked.
Trailer Tire Pressure Monitor Capability Not Detected	The system cannot detect the trailer tire pressure monitoring system.
Trailer Tire Pressure Indication Not Setup See Manual	The trailer tire pressure monitoring system is not setup.

Towing a Trailer

TOWING A TRAILER PRECAUTIONS - GASOLINE

 **WARNING:** Do not exceed the GVWR or the GAWR specified on the certification label.

 **WARNING:** Towing trailers beyond the maximum recommended gross trailer weight exceeds the limit of your vehicle and could result in engine damage, transmission damage, structural damage, loss of vehicle control, vehicle rollover and personal injury.

 **WARNING:** Do not exceed the lowest rating capacity for your vehicle or trailer hitch. Overloading your vehicle or trailer hitch can impair your vehicle stability and handling. Failure to follow this instruction could result in the loss of control of your vehicle, personal injury or death.

 **WARNING:** Make sure that the vertical load on the tow ball is between the minimum and maximum recommended weight at all times. Failure to follow this instruction could result in the loss of control of your vehicle, personal injury or death.

 **WARNING:** Do not cut, drill, weld or modify the trailer hitch. Modifying the trailer hitch could reduce the hitch rating.

 **WARNING:** The anti-lock brake system does not control the trailer brakes.

TOWING A TRAILER PRECAUTIONS - BATTERY ELECTRIC VEHICLE

 **WARNING:** Your vehicle is not approved for trailer towing. Never tow a trailer with your vehicle.

TRAILER BRAKE PRECAUTIONS - GASOLINE

 **WARNING:** Do not connect a trailer's hydraulic brake system directly to your vehicle's brake system. Your vehicle may not have enough braking power and your chances of having a collision greatly increase.

 **WARNING:** Do not tow a trailer fitted with electric trailer brakes unless your vehicle is fitted with a compatible aftermarket electronic trailer brake controller. Failure to follow this instruction could result in the loss of control of your vehicle, personal injury or death. For additional information and assistance, we recommend that you contact an authorized dealer.

Towing a Trailer

Electric brakes and manual, automatic or surge-type trailer brakes are safe if you install them properly and adjust them to the manufacturer's specifications. The trailer brakes must meet local and federal regulations.

The rating for the tow vehicle's braking system operation is at the gross vehicle weight rating, not the gross combined weight rating.

Certain states require functioning trailer brakes for trailers over a specified weight. Be sure to check state regulations for this specified weight.

Ford Motor Company recommends separate functioning brake systems for trailers weighing more than 1,500 lb (680 kg) when loaded.

TOWING A TRAILER LIMITATIONS - GASOLINE

The vehicle's load capacity designation is by weight, not by volume, so you cannot necessarily use all available space when loading a vehicle or trailer.

Note: *Your vehicle could have reduced performance when operating at high altitudes and when heavily loaded or towing a trailer. When driving at elevation, to match driving performance as perceived at sea level, reduce gross vehicle weight and gross combination weight by 2% per 1,000 ft (300 m) elevation.*

LOADING YOUR TRAILER - GASOLINE

To help minimize how trailer movement affects your vehicle when driving:

- Load the heaviest items closest to the trailer floor.
- Load the heaviest items centered between the left and right side trailer tires.
- Load the heaviest items above the trailer axles or just slightly forward toward the trailer tongue. Do not allow the final trailer tongue weight to go above or below 10-15% of the loaded trailer weight. The trailer tongue weight should never exceed 10% of the maximum towing capacity.
- Select a ball mount with the correct rise or drop. When both the loaded vehicle and trailer are connected, the trailer frame should be level, or slightly angled down toward your vehicle, when viewed from the side.

TRAILER TOWING HINTS - GASOLINE

Towing a trailer places an extra load on your vehicle's engine, transmission, axle, brakes, tires and suspension. Periodically inspect these components during and after any towing operation.

Towing a Trailer

When driving with a trailer or payload, a slight takeoff vibration or shudder may be present due to the increased payload weight.

Your vehicle may have a temporary or conventional spare tire. A temporary spare tire is different in diameter or width, tread-type, or is from a different manufacturer than the road tires on your vehicle. Consult information on the tire label or Safety Compliance label for limitations when using.

When towing a trailer:

- Obey country specific regulations for towing a trailer.
- Do not drive faster than 70 mph (113 km/h) during the first 500 mi (800 km).
- Do not make full-throttle starts.
- Check your hitch, electrical connections and trailer wheel lug nuts thoroughly after you have traveled 50 mi (80 km).
- When stopped in congested or heavy traffic during hot weather, place the transmission in park (P) to aid engine and transmission cooling and to help A/C performance.
- Turn off the speed control with heavy loads or in hilly terrain. The speed control may turn off when you are towing on long, steep slopes.
- Shift to a lower gear when driving down a long or steep hill. Do not continuously apply the brakes, as they may overheat and become less effective.
- If your transmission has Grade Assist or Tow/Haul, use this feature when towing. This provides engine braking and helps eliminate excessive transmission shifting for optimum fuel economy and transmission cooling.

- Your vehicle has AdvanceTrac with roll stability control. When towing a trailer, additional loads could cause the AdvanceTrac system to engage during cornering maneuvers. Reduce cornering speeds to make sure that you can maintain control of the vehicle and trailer if the AdvanceTrac system engages.
- Allow more distance for stopping with a trailer attached. Anticipate stops and gradually brake.
- Avoid parking on a slope. However, if you must park on a slope, turn the steering wheel to point your vehicle tires away from traffic flow, set the parking brake, place the transmission in park (P) and place wheel chocks in front and back of the trailer wheels.

Note: *Chocks are not included with your vehicle.*

LAUNCHING OR RETRIEVING A BOAT OR PERSONAL WATERCRAFT - GASOLINE

When backing down a ramp during boat launching or retrieval:

- Do not allow the static water level to rise above the bottom edge of the rear bumper.
- Do not allow waves to break higher than 6 in (15 cm) above the bottom edge of the rear bumper.

Exceeding 6 in (15 cm) could allow water to enter vehicle components, causing internal damage to the components and affecting driveability, emissions and reliability.

Note: *Replace the rear axle lubricant anytime the rear axle has been submerged in water.*

Towing a Trailer

Note: Disconnect the trailer wiring connector before backing the trailer into the water.

Note: Reconnect the trailer wiring connector after removing the trailer from the water.

TOWING WEIGHTS AND DIMENSIONS

RECOMMENDED TOWING WEIGHTS

Market	Website
United States of America	https://www.fordpro.com/en-us/fleet-vehicles/manuals-and-guides/
Canada	https://www.fordpro.com/en-us/fleet-vehicles/manuals-and-guides/

Towing a Trailer

WHAT IS THE MAXIMUM LOADED TRAILER WEIGHT - GASOLINE

The maximum loaded trailer weight is the highest possible weight of a fully loaded trailer the vehicle can tow.

CALCULATING THE MAXIMUM LOADED TRAILER WEIGHT FOR YOUR VEHICLE - GASOLINE

1. Start with the gross combined weight rating for your vehicle model and axle ratio.
2. Subtract all of the following that apply to your vehicle:
 - Vehicle curb weight.
 - Hitch hardware weight, for example a draw bar, ball, locks or weight distributing hardware.
 - Driver weight.
 - Passenger weight.
 - Payload, cargo and luggage weight.
 - Aftermarket equipment weight.

This equals the maximum loaded trailer weight for this combination.

Note: *The trailer tongue load is considered part of the payload for your vehicle. Reduce the total payload by the final trailer tongue weight.*

Note: *Consult an authorized dealer to determine the maximum trailer weight allowed for your vehicle if you are not sure.*

Integrated Trailer Brake Controller

WHAT IS THE INTEGRATED TRAILER BRAKE CONTROLLER

The trailer brake controller assists in smooth and effective trailer braking based on the towing vehicle's brake pressure.

INTEGRATED TRAILER BRAKE CONTROLLER PRECAUTIONS



WARNING: Use the integrated trailer brake controller to properly adjust the trailer brakes and check all connections before towing a trailer. Failure to follow this instruction could result in the loss of control of your vehicle, personal injury or death.

- Only use the manual control lever for proper adjustment of the gain during trailer setup. Misuse, such as application during trailer sway, could cause instability of trailer or tow vehicle.
- Avoid towing in adverse weather conditions. The trailer brake controller does not provide anti-lock control of the trailer wheels. Trailer wheels can lock up on slippery surfaces, resulting in reduced stability of trailer and tow vehicle.
- The trailer brake controller is only a factory-installed or dealer-installed item. Ford is not responsible for warranty or performance of the controller due to misuse or customer installation.

Note: Do not attempt removal of the trailer brake controller without consulting the *Workshop Manual*. Damage to the unit may result.

Note: Make sure to set the integrated trailer brake controller gain to 0 if you are using an aftermarket trailer brake controller.

USING THE INTEGRATED TRAILER BRAKE CONTROLLER

1. Make sure the trailer brakes are in good working condition, functioning normally and properly adjusted. See your trailer dealer if necessary.

Note: An authorized dealer can diagnose the trailer brake controller to determine exactly which trailer fault has occurred. Your vehicle warranty does not cover issues with your trailer.

2. Hook up the trailer and make the electrical connections according to the trailer manufacturer's instructions.

Note: Select default mode if the trailer has surge brakes, or no brakes at all. The system has no effect on the braking performance of the trailer in either of these cases.

Note: If a trailer is connected by a four-pin connector, the trailer braking function will not be supported.

3. When you plug in a trailer with electric or electric-over-hydraulic brakes, a message confirming connection appears in the information display.
4. Use the gain adjustment to find the desired starting point. A gain setting of 6.0 is a good starting point for heavier loads.

Note: Use the following steps to adjust the gain setting whenever road, weather and trailer, or vehicle loading conditions, change from when you initially set the gain.

5. In a traffic-free environment, tow the trailer on a dry, level surface and squeeze the manual control lever completely.

Integrated Trailer Brake Controller

- If the trailer wheels lock up, indicated by squealing tires, reduce the gain setting. If the trailer wheels turn freely, increase the gain setting. Repeat Steps 5 and 6 until the gain setting is at a point just below trailer wheel lock-up. If towing a heavier trailer, trailer wheel lock-up may not be attainable even with the maximum gain setting of 10.

Note: Only perform this procedure at speeds of approximately 20–25 mph (30–40 km/h).

Note: The trailer brake controller reduces output at vehicle speeds below 11 mph (18 km/h) so that trailer and vehicle braking is not jerky or harsh. This feature is only available when applying the brakes using your vehicle's brake pedal, not the controller.

Note: Your vehicle's brake system and the trailer brake system work independently of each other. Changing the gain setting on the controller does not affect the operation of your vehicle's brakes whether you attach a trailer or not.

Note: With the proper electrical connection, pressing your vehicle brake pedal or using the manual control lever illuminates both trailer and vehicle brake lamps.

Note: When you switch the engine off, the controller output is disabled and the display and module shut down. The controller module and display turn on when you switch the ignition on.

Adjusting the Trailer Brake Gain

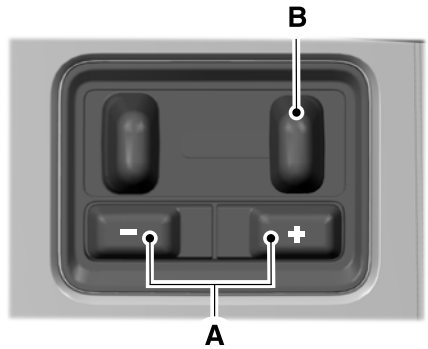

- A Increase or decrease the amount of gain in set increments.
- B Slide the control to engage the trailer brakes.

Note: Adjust gain setting before using the trailer brake controller for the first time.

Note: The gain should be set to provide the maximum trailer braking assistance while making sure the trailer wheels do not lock when using the brakes. Locked trailer wheels may lead to trailer instability.

Note: Setting adjustments are saved when a trailer profile is selected.

ADJUSTING THE INTEGRATED TRAILER BRAKE CONTROLLER MODE

Select the correct integrated trailer brake controller mode option using the touchscreen.

Note: Trailer brake gain settings are saved to the active trailer profile.

Integrated Trailer Brake Controller

Selecting the Trailer Brake Type

1. Press **Default** for trailers with electromagnetic drum brake systems or press **Electric over Hydraulic** for trailers with electrically actuated hydraulic brake systems.
2. Press **Save**.

Selecting the Trailer Brake Effort

1. Select a setting for your trailer.
Note: *The default value is **Low** and is the recommended setting for most trailers. Select a different setting if your trailer's brakes require more initial voltage, or you prefer more aggressive trailer braking.*
2. Press **Save**.

INTEGRATED TRAILER BRAKE CONTROLLER – TROUBLESHOOTING

INTEGRATED TRAILER BRAKE CONTROLLER – INFORMATION MESSAGES

Message	Action
Trailer Connected	The system detects a correct trailer connection during a given ignition cycle.
Trailer Disconnected	The system detects the trailer wiring connection is disconnected, during a given ignition cycle.
Trailer Wiring Fault	The system detects an electrical fault in the trailer brake circuit. If this message appears without a trailer attached, see your authorized dealer. If a trailer is attached, inspect and repair the trailer wiring.
Trailer Brake Gain: {trailer gain value:#0.0}	Displays the current gain setting for the trailer brake.
Trailer Brake Gain: {trailer gain value:#0.0} No Trailer	Displays the current gain setting for the trailer brake when you do not have a trailer connected.

Integrated Trailer Brake Controller

INTEGRATED TRAILER BRAKE CONTROLLER – FREQUENTLY ASKED QUESTIONS

How do I determine if there is an issue with the wiring on my vehicle?

- A message displays accompanied by a single tone, when no trailer is connected. This indicates that the issue is between the trailer brake controller and the 7-pin connector at the bumper.

How do I determine if there is an issue with the wiring on my trailer?

- A message only displays with a trailer connected. Consult your trailer dealer for assistance.

Trailer Sway Control

HOW DOES TRAILER SWAY CONTROL WORK

The system applies the brakes to the individual wheels and reduces engine torque to aid vehicle stability.

If the trailer begins to sway, the stability control lamp flashes and the message **Trailer Sway Reduce Speed** appears in the information display.

Stop your vehicle as soon as it is safe to do so. Check the vertical weight on the tow ball and trailer load distribution.

TRAILER SWAY CONTROL PRECAUTIONS

Note: *This feature only activates when significant trailer sway occurs.*

Note: *This feature does not prevent trailer sway, but reduces it once it begins.*

Note: *This feature cannot stop all trailers from swaying.*

Note: *In some cases, if vehicle speed is too high, the system may activate multiple times, gradually reducing vehicle speed.*

Driving Hints

OFF-ROAD DRIVING - VEHICLES WITH: TRAIL PACKAGE

WHAT IS OFF-ROAD DRIVING

Off-road driving is driving your vehicle on unsurfaced roads or trails, made from dirt, rocks, sand and mud.

OFF-ROAD DRIVING PRECAUTIONS



WARNING: If you continue to drive your vehicle when the engine is overheating, the engine could stop without warning. Failure to follow this instruction could result in the loss of control of your vehicle.

Before going off-road driving, consult with all the appropriate government entities to determine where you are legally allowed to operate your vehicle and what permits or registrations are required to do so.

Inspect your vehicle before and after any off-road driving.

Familiarize yourself with the dimensions of your vehicle including approach angles, breakover angles, and ground clearance.

Also familiarize yourself with the features of your vehicle. Some of these features such as drive modes and cameras can improve your off-road driving experience.

Secure loose objects inside your vehicle and in the cargo area.

BASIC OFF-ROAD DRIVING TECHNIQUES

Grip the steering wheel with your thumbs on the outside of the rim. This reduces the risk of injury due to abrupt steering wheel motions that occur when negotiating rough terrain.

Control your throttle, brake and steering inputs in a smooth manner. Sudden inputs to the controls can cause a loss of traction for the vehicle, especially when on sloped terrain or crossing obstacles such as rocks or logs.

Look ahead on your route noting upcoming obstacles, surface texture or color changes or any other factors which may indicate a change in available traction. Adjust the vehicle speed and route to avoid a loss in traction. Conditions can change causing the course to vary day to day. Mark obstacles with GPS markers to avoid potential vehicle damage. Where necessary, get out of your vehicle and check the terrain.

When driving off-road, if the front or rear suspension is bottoming-out or excessive contact with the skid-plates is happening, reduce the vehicle's speed to avoid potential damage to your vehicle.

If you are driving in a dusty area, be sure to leave ample distance between your vehicle and any other vehicles to allow for adequate vision.

When driving off-road verify that your wipers and washers are working properly and reduce your speed for better visibility.

When driving in desert conditions, we recommend driving with your headlamps on to help other drivers easily see you.

When convoying with other vehicles, we recommend that communication is used, and the lead vehicle notify other vehicles of upcoming obstacles.

Driving Hints

Keep available ground clearance in mind and pick a route that minimizes the risk of catching the underside of the vehicle on an obstacle.

When negotiating low speed obstacles, applying light brake pressure in conjunction with the throttle allows you to negotiate the obstacle in a more controlled manner.

Driving off-road requires a high amount of concentration. Even if your local law does not prohibit drinking alcohol when driving off-road we do not recommend it.

AFTER DRIVING YOUR VEHICLE OFF-ROAD



WARNING: After off-road use, before returning to the road, check the wheels and tires for damage. Off-road use may cause damage to your wheels and tires that can lead to tire failure, loss of vehicle control, serious injury or death.



WARNING: Always re-inflate tires to recommended tire pressures before the vehicle is operated on-road. The recommended pressure is located on the Tire Label or Safety Compliance Certification Label, located on the driver or passenger side B-Pillar.

Driving off-road places more stress on your vehicle than most on-road driving. After driving off-road check for damage to your vehicle and, if necessary, have your vehicle fixed as soon as possible.

Inspect the underbody of your vehicle by checking tires, body structure, steering, suspension, and exhaust system for damage.

Check the radiator for mud and debris and clean as needed.

Remove accumulations of plants or brush. These things could be a fire hazard or hide damage to the fuel lines, brake hoses, and propeller shafts.

After extended operation in mud, sand, water, or similar dirty conditions, inspect the underbody and clean your vehicle as soon as possible.

If you experience unusual vibration after driving in mud, slush or similar conditions, check the wheels for impacted material. Impacted material can cause vibrations while driving and wheel imbalance. Remove the material to resolve the problem.

COLD WEATHER PRECAUTIONS

The functional operation of some components and systems can be affected at temperatures below approximately -13°F (-25°C).

DRIVING ON SNOW AND ICE



WARNING: If you are driving in slippery conditions that require tire chains or cables, then it is critical that you drive cautiously. Keep speeds down, allow for longer stopping distances and avoid aggressive steering to reduce the chances of a loss of vehicle control which can lead to serious injury or death. If the rear end of your vehicle slides while cornering, steer in the direction of the slide until you regain control of your vehicle.

Driving Hints

On ice and snow, you should drive more slowly than usual. Your vehicle has an anti-lock braking system, apply the brake pedal steadily. Do not pump the brake pedal. See **Anti-Lock Braking System Limitations** (page 225).

BREAKING-IN

Your vehicle requires a break-in period. For the first 1,000 mi (1,600 km), avoid driving at high speeds, heavy braking, aggressive shifting or using your vehicle to tow. During this time, your vehicle may exhibit some unusual driving characteristics.

DRIVING ECONOMICALLY

The following helps to improve fuel consumption:

- Drive smoothly, accelerate gently and anticipate the road ahead to avoid heavy braking.
- Regularly check your tire pressures and make sure that they are inflated to the correct pressure.
- Follow the recommended maintenance schedule and carry out the recommended checks.
- Plan your journey and check the traffic before you set off. It is more efficient to combine errands into a single trip whenever possible.
- Avoid idling the engine in cold weather or for extended periods. Start the engine only when you are ready to set off.
- Do not carry unnecessary weight in your vehicle as extra weight wastes fuel.
- Do not add unnecessary accessories to the exterior of your vehicle, for example running boards. If you use a roof rack, remember to fold it down or remove it when not in use.

- Do not shift into neutral when you are braking or when your vehicle is slowing down.
- Shut all windows when driving at high speeds.
- Switch off all electric systems when not in use, for example air conditioning. Make sure that you unplug any accessories from the auxiliary power points when not in use.

DRIVING IN SPECIAL CONDITIONS

DRIVING THROUGH MUD AND WATER

Mud

Be cautious of sudden changes in vehicle speed or direction when you are driving in mud. Even all-wheel drive and four-wheel drive vehicles can lose traction in mud. If your vehicle slides, steer in the direction of the slide until you regain control of your vehicle. After driving through mud, clean off residue stuck to rotating driveshafts and tires. Excess residue can cause an imbalance that could damage drive components.

Note: *If your vehicle gets stuck in mud, it could be rocked out by shifting between forward and reverse gears, stopping between shifts in a steady pattern. Press lightly on the accelerator in each gear.*

Water

If you must drive through water approach it cautiously. See **Driving Through Shallow Water** (page 332).

Driving Hints

DRIVING ON HILLY OR SLOPING TERRAIN

Although natural obstacles could make it necessary to travel diagonally up or down a hill or steep incline, you should try to drive straight up or straight down.

Note: *Avoid turning on steep slopes or hills. A danger lies in losing traction, slipping sideways and possible vehicle roll over. Whenever driving on a hill, determine beforehand the route you can use. Do not drive over the crest of a hill without seeing what conditions are on the other side. Do not drive in reverse over a hill without the aid of an observer.*

Apply just enough power to the wheels to climb the hill. Too much power causes the tires to slip, spin or lose traction, and you could lose control of your vehicle. When descending a steep hill, do not descend the hill in neutral. Avoid sudden hard braking to keep the front wheels rolling and to maintain your vehicle's steering.

Note: *Your vehicle has an anti-lock braking system, apply the brake pedal steadily. Do not pump the brake pedal.*

DRIVING IN SAND

When driving over sand, try to keep all four wheels on the most solid area of the trail. Shift to a lower gear and drive steadily through the terrain. Apply the accelerator slowly and avoid excessive wheel slip. Do not drive your vehicle in deep sand for an extended period of time. This could overheat the system. A message appears in the information display. See **All-Wheel Drive – Information Messages** (page 224).

Note: *If your vehicle gets stuck in sand, it could be rocked out by shifting between forward and reverse gears, stopping between shifts in a steady pattern. Press lightly on the accelerator in each gear.*

DRIVING THROUGH SHALLOW WATER - GASOLINE



WARNING: Do not attempt to cross a deep or flowing body of water. Failure to follow this instruction could result in the loss of control of your vehicle, personal injury or death.

Note: *Driving through standing water can cause vehicle damage.*

Note: *Engine damage can occur if water enters the air filter.*

Before driving through standing water, check the depth. Never drive through water that is higher than the bottom of the wheel hubs.

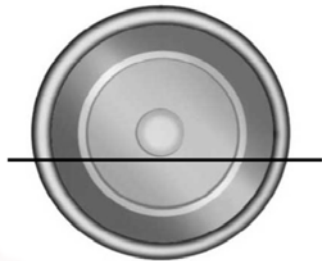

When driving through standing water, drive very slowly and do not stop your vehicle. Your brake performance and traction could be limited. After driving through water and as soon as it is safe to do so:

- Lightly press the brake pedal to dry the brakes and to check that they work.
- Turn the steering wheel to check that the steering power assist works.

Check the function of the following:

- Horn
- Exterior lights

Driving Hints

DRIVING THROUGH SHALLOW WATER - BATTERY ELECTRIC VEHICLE



WARNING: Do not attempt to cross a deep or flowing body of water. Failure to follow this instruction could result in the loss of control of your vehicle, personal injury or death.

Note: *Driving through standing water can cause vehicle damage.*

Before driving through standing water, check the depth. Never drive through water that is higher than the bottom of the wheel hubs.

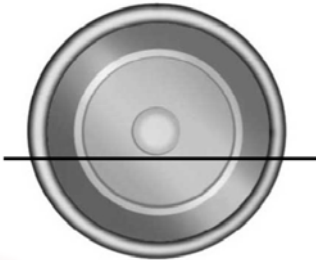

When driving through standing water, drive very slowly and do not stop your vehicle. Your brake performance and traction could be limited. After driving through water and as soon as it is safe to do so:

- Lightly press the brake pedal to dry the brakes and to check that they work.
- Turn the steering wheel to check that the steering power assist works.

Check the function of the following:

- Horn
- Exterior lights

ELECTRIC VEHICLE

MAXIMIZING YOUR DRIVING RANGE

Driving in Cold Weather

Keep your vehicle charged before heading out into cold weather.

Use the heated seats and steering wheel for comfort along with moderate cabin temperature and fan settings to reduce energy needed for climate control.

Preconditioning Your Vehicle

You can precondition your vehicle by using departure and comfort settings to warm or cool your cabin and the high voltage battery when your vehicle is plugged in. By using energy from your charging source prior to your departure, battery temperature can be managed for best driving performance and less energy will be needed for heating or cooling of the cabin at the start of your drive. This helps maximize your driving range. See **Setting the Charging Schedule and Preferences** (page 208).

Note: *You can also access departure and comfort settings using the FordPass App.*

Note: *Lower cabin temperature settings on the climate control system results in better trip range.*

Parking Your Vehicle

At temperatures just above the freezing point and lower, plug your vehicle in when not in use to maintain high voltage battery performance.

When possible park your vehicle under a covered area or in a garage. This will help to moderate temperatures which affect performance of the high voltage battery and require energy to heat or cool the cabin.

Driving Hints

Driving Style

Range is reduced when driving aggressively or at consistently high speeds. Aggressive driving for extended periods could also result in reducing your battery's efficiency and lifespan.

FLOOR MATS



WARNING: Use a floor mat designed to fit the footwell of your vehicle that does not obstruct the pedal area. Failure to follow this instruction could result in the loss of control of your vehicle, personal injury or death.



WARNING: Pedals that cannot move freely can cause loss of vehicle control and increase the risk of serious personal injury.



WARNING: Secure the floor mat to both retention devices so that it cannot slip out of position and interfere with the pedals. Failure to follow this instruction could result in the loss of control of your vehicle, personal injury or death.



WARNING: Do not place additional floor mats or any other covering on top of the original floor mats. This could result in the floor mat interfering with the operation of the pedals. Failure to follow this instruction could result in the loss of control of your vehicle, personal injury or death.



WARNING: Always make sure that objects cannot fall into the driver foot well while your vehicle is moving. Objects that are loose can become trapped under the pedals causing a loss of vehicle control.



To install floor mats that have eyelets, position the floor mat eyelet over the retention post and press down to lock in position. Repeat for all eyelets on the floor mat.

To remove the floor mats, reverse the installation procedure.

Note: Regularly check the floor mats to make sure they are secure.

Crash and Breakdown Information

ROADSIDE ASSISTANCE - GASOLINE

Vehicles Sold in the United States: Getting Roadside Assistance

If you have a vehicle concern, Ford Motor Company offers a complimentary roadside assistance program. This program is separate from the New Vehicle Limited Warranty.

The service is available:

- 24 hours a day, seven days a week.
- For the coverage period supplied with your vehicle.

Knowing your vehicle's VIN, mileage and your specific location allows help to get to you faster.

Roadside Assistance covers:

- A flat tire change with a good spare (except vehicles supplied with a tire inflation kit).
- Battery jump start.
- Lock-out assistance (key replacement cost is the customer's responsibility).
- Fuel delivery — independent service contractors, if not prohibited by state, local or municipal law, shall deliver up to 2 gal (8 L) of gasoline or 5 gal (20 L) of diesel fuel to a disabled vehicle. Roadside assistance limits fuel delivery service to two no-charge occurrences within a 12-month period.
- Winch out — available within 100 ft (30 m) of a paved or county maintained road, no recoveries.

- Towing — independent service contractors, if not prohibited by state, local or municipal law, shall tow Ford eligible vehicles to an authorized dealer within 50 mi (80 km) of the disablement location or to the nearest authorized dealer. If a member requests a tow to an authorized dealer that is more than 50 mi (80 km) from the disablement location, the member shall be responsible for any mileage costs in excess of 50 mi (80 km). Warranty towing, non-warranty towing and collision towing are available.
- Roadside Assistance includes up to \$200 for a towed trailer if the disabled eligible vehicle requires service at the nearest authorized dealer. If the towing vehicle is operational but the trailer is not, then the trailer does not qualify for any roadside services.

Vehicles Sold in the United States: Using Roadside Assistance

United States vehicle customers who require Roadside Assistance, call 1-800-241-3673.

If you need to arrange roadside assistance on your own, Ford Motor Company reimburses a reasonable amount for towing to the nearest dealership within 50 mi (80 km). To obtain reimbursement information, United States vehicle customers call 1-800-241-3673. Customers need to submit their original receipts.

Vehicles Sold in Canada: Getting Roadside Assistance

If you have a vehicle concern, Ford Motor Company of Canada, Limited offers a complimentary roadside assistance program. This program is eligible within Canada or the continental United States.

The service is available 24 hours a day, seven days a week.

Crash and Breakdown Information

This program is separate from the New Vehicle Limited Warranty, but the coverage is concurrent with the powertrain coverage period of your vehicle. Canadian roadside coverage and benefits may differ from the U.S. coverage. For complete details, see your Warranty Guide at www.ford.com/support/warranty/.

Download the Sykes4Ford Roadside Assistance App for access to your roadside assistance services. For more information, scan here:



If you require more information, please call us in Canada at 1-800-665-2006, or visit our website at www.ford.ca.

Ford Motor Company reserves the right to modify or discontinue Roadside Assistance at any time. Certain restrictions apply to Roadside Assistance benefits.

For further details, call
1-800-665-2006 (Canada)
1-800-241-3673 (United States)

ROADSIDE ASSISTANCE - BATTERY ELECTRIC VEHICLE

Vehicles Sold in the United States: Getting Roadside Assistance

If you have a vehicle concern, Ford Motor Company offers a complimentary roadside assistance program. This program is separate from the New Vehicle Limited Warranty.

The service is available:

- 24 hours a day, seven days a week.
- For the coverage period supplied with your vehicle.

Knowing your vehicle's VIN, mileage and your specific location gets help to you faster.

Roadside Assistance covers:

- A flat tire change with a good spare — except for vehicles supplied with a tire inflation kit.
- 12 V battery jump start.
- Lock-out assistance (key replacement cost is the customer's responsibility).
- In the event your vehicle's high-voltage battery does not have enough power to move, you can choose where you would like your vehicle towed (within a 50 mi (80 km) radius):
 - EV Certified Ford or Lincoln Dealer.
 - Nearest public charger.
 - Your home residence.
- Winch out — available within 100 ft (30 m) of a paved or county maintained road, no recoveries.

Crash and Breakdown Information

- Towing — independent service contractors, if not prohibited by state, local or municipal law, shall tow Ford eligible vehicles to an authorized dealer within 50 mi (80 km) of the disablement location or to the nearest authorized dealer. If a member requests a tow to an authorized dealer that is more than 50 mi (80 km) from the disablement location, the member shall be responsible for any mileage costs in excess of 50 mi (80 km). Warranty towing, non-warranty towing and collision towing are available.
- Roadside Assistance includes up to \$200 for a towed trailer if the disabled eligible vehicle requires service at the nearest authorized dealer. If the towing vehicle is operational but the trailer is not, then the trailer does not qualify for any roadside services.

Vehicles Sold in the United States: Using Roadside Assistance

United States vehicle customers who require Roadside Assistance, call 1-800-241-3673.

If you need to arrange roadside assistance on your own, Ford Motor Company reimburses a reasonable amount for towing to the nearest dealership within 50 mi (80 km). To obtain reimbursement information, United States vehicle customers call 1-800-241-3673. Customers need to submit their original receipts.

Vehicles Sold in Canada: Getting Roadside Assistance

If you have a vehicle concern, Ford Motor Company of Canada, Limited offers a complimentary roadside assistance program. This program is eligible within Canada or the continental United States.

The service is available 24 hours a day, seven days a week.

This program is separate from the New Vehicle Limited Warranty, but the coverage is concurrent with the powertrain coverage period of your vehicle. Canadian roadside coverage and benefits may differ from the U.S. coverage. For complete details, see your Warranty Guide at www.ford.com/support/warranty/.

Download the Sykes4Ford Roadside Assistance App for access to your roadside assistance services. For more information, scan here:



If you require more information, please call us in Canada at 1-800-665-2006, or visit our website at www.ford.ca.

Ford Motor Company reserves the right to modify or discontinue Roadside Assistance at any time. Certain restrictions apply to Roadside Assistance benefits.

For further details, call
1-800-665-2006 (Canada)
1-800-241-3673 (United States)

Crash and Breakdown Information

HIGH VOLTAGE BATTERY VEHICLE PRECAUTIONS - BATTERY ELECTRIC VEHICLE

In the event of damage or fire involving an electric vehicle or hybrid-electric vehicle:

- Assume the high-voltage battery and associated components are energized and fully charged.
- Exposed electrical components, wires and high-voltage batteries present potential high-voltage shock hazards.
- Venting high-voltage battery vapors are potentially toxic and flammable.
- Physical damage to the vehicle or high-voltage battery could result in immediate or delayed release of toxic, flammable gases and fire.

Vehicle information and general safety practices include reviewing the owner's manual and becoming familiar with your vehicle's safety information and recommended safety practices.

Crashes

A crash or impact significant enough to require an emergency response for conventional vehicles would also require the same response for an electric or hybrid-electric vehicle.

If Possible:

1. Move your vehicle to a safe, nearby location and remain on the scene.
2. Roll down the windows before you switch your vehicle off.
3. Place your vehicle in park (P), set the parking brake, switch off the vehicle, activate the hazard flashers and move your key(s) at least 16 ft (5 m) away from the vehicle.

Always:

- Call emergency assistance if needed and advise that an electric or hybrid-electric vehicle is involved.
- Avoid contact with leaking fluids and gases, and remain out of the way of oncoming traffic until emergency responders arrive.
- When emergency responders arrive, tell them that the vehicle involved is an electric vehicle or hybrid-electric vehicle.

Fires

As with any vehicle, call emergency assistance immediately if you see sparks, smoke or flames coming from the vehicle. Remain a safe distance from the vehicle and try to stay clear of the smoke.

1. Exit the vehicle immediately.
2. Advise emergency assistance that an electric or hybrid-electric vehicle is involved.
3. As with any vehicle fire, do not inhale smoke, vapors or gas from the vehicle, as they may be hazardous.

Post-Incident

1. Do not store a severely damaged vehicle with a lithium-ion battery inside a structure or within 49 ft (15 m) of any structure or vehicle.
2. Make sure that passenger and luggage compartments remain ventilated.
3. Call emergency assistance if you observe leaking fluids, sparks, smoke or flames, or hear gurgling or bubbling from the high-voltage battery.

Crash and Breakdown Information

SWITCHING THE HAZARD FLASHERS ON AND OFF



The hazard flasher button is on the instrument panel. Press the button to switch the hazard flashers on if your vehicle is creating a safety hazard for other road users.

When you switch the hazard flashers on, all front and rear direction indicators flash.

Note: *The hazard flashers operate when the ignition is in any position, or if the key is not in the ignition. The battery loses charge and could have insufficient power to restart your vehicle.*

Press the button again to switch them off.

JUMP STARTING THE VEHICLE

JUMP STARTING PRECAUTIONS - GASOLINE



WARNING: Batteries normally produce explosive gases which can cause personal injury. Therefore, do not allow flames, sparks or lighted substances to come near the battery. When working near the battery, always shield your face and protect your eyes. Always provide correct ventilation.



WARNING: Keep batteries out of reach of children. Batteries contain sulfuric acid. Avoid contact with skin, eyes or clothing. Shield your eyes when working near the battery to protect against possible splashing of acid solution. In case of acid contact with skin or eyes, flush immediately with water for a minimum of 15 minutes and get prompt medical attention. If acid is swallowed, call a physician immediately.



WARNING: Use only adequately sized cables with insulated clamps.



WARNING: Make sure that the cables are clear of any moving parts and fuel delivery system parts.



WARNING: Connect batteries with only the same nominal voltage.



WARNING: If the engine is running while the hood is open, stay clear of moving engine components. Failure to follow this warning could result in serious personal injury or death.

Do not attempt to push-start an automatic transmission vehicle. This could cause transmission damage.

Do not disconnect the battery of the disabled vehicle. This could damage your vehicle's electrical system.

JUMP STARTING PRECAUTIONS - BATTERY ELECTRIC VEHICLE



WARNING: Connect batteries with only the same nominal voltage.



WARNING: Use only adequately sized cables with insulated clamps.

Note: *This procedure is only for the 12 volt battery.*

Note: *Your vehicle has a 12 volt battery that is under the driver seat. The 12 volt battery controls the switches and contacts that engage the high voltage battery. Do not jump start the high voltage battery using a standard 12 volt battery. Tow your vehicle to an authorized dealer if the high voltage battery does not accept a regular charge.*

Crash and Breakdown Information

Note: Do not attempt to push start your vehicle. You could cause transmission damage.

Note: Do not disconnect the 12 volt battery from your vehicle electrical system.

PREPARING THE VEHICLE

Use only a 12 volt supply to start your vehicle.

Park the booster vehicle close to the hood of the disabled vehicle, making sure the two vehicles do not touch.

JUMP STARTING THE VEHICLE - GASOLINE

Your vehicle has a positive (+) access terminal and a negative (-) ground connection point that you can access under the hood, even though the actual battery is under the driver seat. You can jump your vehicle using these points.

The positive (+) access terminal is next to the fuse box, under a red cap. To access the positive (+) terminal, lift the red cap up.

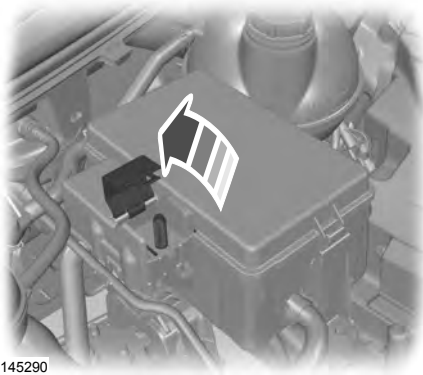

The negative (-) terminal is a post on the driver side, near the hood hinge. It is a ground connection point. You need to remove the rubber covering first.

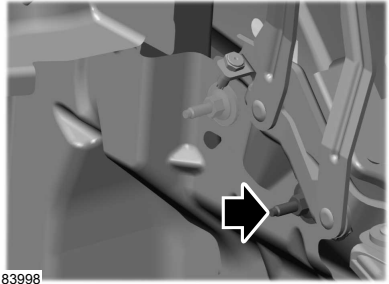

WARNING: Make sure that the cables are clear of any moving parts and fuel delivery system parts.

Note: In the illustration, the bottom vehicle represents the booster vehicle.

Crash and Breakdown Information

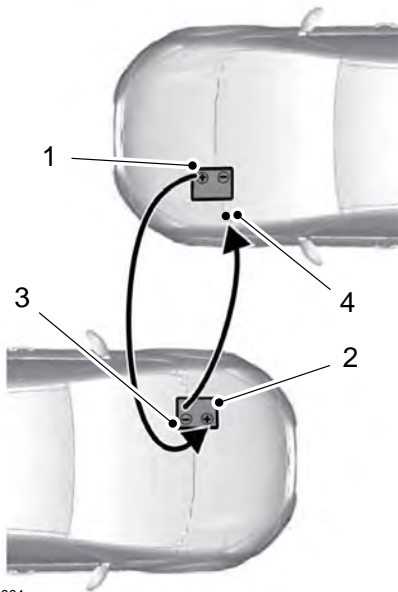

E142664

1. Connect the positive (+) jumper cable to the positive (+) access terminal of the vehicle with the discharged battery.
2. Connect the other end of the positive (+) cable to the positive (+) terminal of the assisting battery.
3. Connect the negative (-) cable to the negative (-) terminal of the assisting battery.
4. Make the final connection of the negative (-) cable to the ground connection point of the vehicle with the discharged battery.



WARNING: Do not connect the negative jumper cable to any other part of your vehicle. Use the ground point.

5. Start the engine of the booster vehicle and rev the engine moderately, or press the accelerator gently to keep your engine speed between 2000 and 3000 rpms, as shown in your tachometer.
6. Start the engine of the disabled vehicle.
7. Once you start the disabled vehicle, run both vehicle engines for an additional three minutes before disconnecting the jumper cables.

Remove the jumper cables in the reverse order that they were connected.

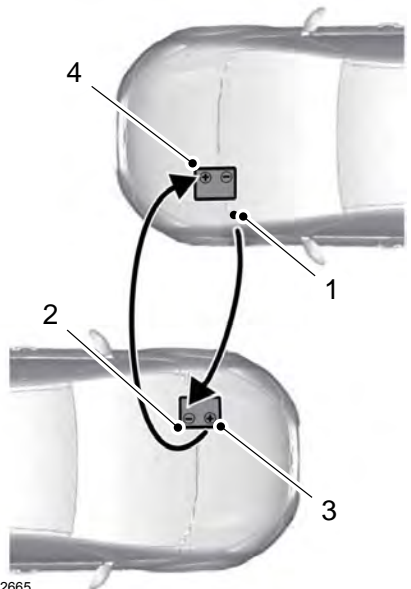

E142665

After you start the disabled vehicle and remove the jumper cables, allow your vehicle to idle for several minutes so the battery can recharge.

Crash and Breakdown Information

JUMP STARTING THE VEHICLE - BATTERY ELECTRIC VEHICLE

To Start Your Vehicle

1. Run the engine of the booster vehicle at a moderately high speed.
2. Move the transmission selector lever of the low charge vehicle to park (P).
3. Switch on the ready to drive mode. See **Starting the Vehicle** (page 180).
4. Run both vehicles for a minimum of three minutes before disconnecting the cables.

Note: Do not switch the headlamps on when disconnecting the cables. The peak voltage could damage the bulbs.

Disconnect the cables in the reverse order.

POST-CRASH ALERT SYSTEM

WHAT IS THE POST-CRASH ALERT SYSTEM

The system helps draw attention to your vehicle in the event of a serious impact.

HOW DOES THE POST-CRASH ALERT SYSTEM WORK

The system is designed to turn the hazard flashers on, turn the courtesy lamps on, intermittently sound the horn and unlock all doors in the event of a serious impact that deploys an airbag or the seatbelt pretensioners.

POST-CRASH ALERT SYSTEM LIMITATIONS

Depending on applicable laws in the country your vehicle was built for, the horn does not sound in the event of a serious impact.

SWITCHING THE POST-CRASH ALERT SYSTEM OFF

Press the hazard flasher switch, the unlock button on the remote control, the panic button on the remote control or cycle the ignition to switch the system off.

Note: The alert turns off when the vehicle battery runs out of charge.

POST-COLLISION BRAKING

How Does Post-Collision Braking Work

In the event of a moderate to severe crash, the braking system reduces the vehicle's speed to prevent or reduce the impact of a potential secondary crash.

Post-Collision Braking Limitations

Post-collision braking does not activate if any of the following occur:

- The anti-lock braking system is damaged during the collision.
- Electronic stability control is disabled.

Overriding Post-Collision Braking

You can override post-collision braking by pressing the brake or accelerator pedal.

Post-Collision Braking Indicators



It flashes when a post-collision braking event is occurring.

AUTOMATIC CRASH SHUTOFF

WHAT IS AUTOMATIC CRASH SHUTOFF - GASOLINE

The automatic crash shutoff is designed to stop the fuel going to the engine in the event of a moderate or severe crash.

Crash and Breakdown Information

Note: *Not every impact causes a shutoff.*

WHAT IS AUTOMATIC CRASH SHUTOFF - BATTERY ELECTRIC VEHICLE

The system deactivates the high voltage system if it is a battery or hybrid-electric vehicle, in the event of a moderate or severe crash.

AUTOMATIC CRASH SHUTOFF PRECAUTIONS - GASOLINE



WARNING: If your vehicle has been involved in a crash, have the fuel system checked. Failure to follow this instruction could result in fire, personal injury or death.

RE-ENABLING YOUR VEHICLE

1. Switch the ignition off.
2. Attempt to start your vehicle.
3. Switch the ignition off.
4. Attempt to start your vehicle.

Note: *If your vehicle does not start after the third attempt, have your vehicle checked as soon as possible.*

RECOVERY TOWING

ACCESSING THE REAR TOWING POINT - BUS/VAN



Crash and Breakdown Information

TRANSPORTING THE VEHICLE

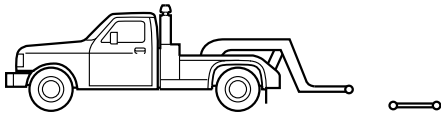

When using wheel lift equipment to tow the vehicle from the front, place the rear wheels on a tow dolly.

When using wheel lift equipment to tow the vehicle from the rear, place the front wheels on a tow dolly.

FAIL-SAFE COOLING - 3.5L DURATEC/3.5L ECOBOOST™

WHAT IS FAIL-SAFE COOLING

Fail-safe cooling allows you to temporarily drive your vehicle before any incremental component damage occurs due to overheating.

The fail-safe distance depends on outside temperature, vehicle load and terrain.

HOW DOES FAIL-SAFE COOLING WORK

If the engine reaches a preset over-temperature condition, the engine automatically switches to alternating cylinder operation. Each disabled cylinder acts as an air pump and cools the engine.

When this occurs, your vehicle still operates, however:

- Engine power is limited.
- The air conditioning system turns off.

Continued operation increases the engine temperature, causing the engine to completely shut down. Your steering and braking effort increases in this situation.

When the engine temperature cools, you can re-start the engine.

Note: *Have your vehicle checked as soon as possible to minimize engine damage.*

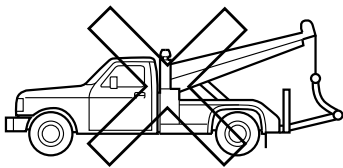
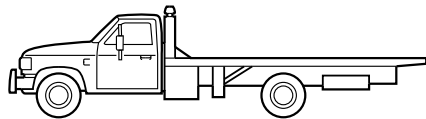

If you need to have your vehicle towed, contact a professional towing service or your roadside assistance service provider.

We recommend the use of a wheel lift and dollies or flatbed equipment to tow your vehicle. Do not tow with a slingbelt. We do not approve a slingbelt towing procedure. Vehicle damage may occur if towed incorrectly, or by any other means.

Your manufacturer produces a towing manual for all authorized tow truck operators. Have your tow truck operator refer to this manual for proper hook-up and towing procedures.

Towing your vehicle requires that all wheels be off the ground. This prevents damage to the mechanical systems and vehicle.

Crash and Breakdown Information

DRIVING WHEN FAIL-SAFE MODE IS ACTIVATED



WARNING: Fail-safe mode is for use during emergencies only. Operate your vehicle in fail-safe mode only as long as necessary to bring your vehicle to rest in a safe location and seek immediate repairs. When in fail-safe mode, your vehicle will have limited power, will not be able to maintain high-speed operation, and may completely shut down without warning, potentially losing engine power, power steering assist, and power brake assist, which may increase the possibility of a crash resulting in serious injury.



WARNING: Do not remove the coolant reservoir cap when the engine is on or the cooling system is hot. Wait 10 minutes for the cooling system to cool down. Cover the coolant reservoir cap with a thick cloth to prevent the possibility of scalding and slowly remove the cap. Failure to follow this instruction could result in personal injury.

Continued operation increases the engine temperature, causing the engine to completely shut down. Your steering and braking effort increases in this situation.

When the engine temperature cools, you can re-start the engine. Have your vehicle checked as soon as possible to minimize engine damage.

Your vehicle has limited engine power when in the fail-safe mode, drive your vehicle with caution. Your vehicle does not maintain high-speed operation and the engine may operate poorly.

Remember that the engine is capable of automatically shutting down to prevent engine damage. In this situation:

1. Pull off the road as soon as safely possible and switch the engine off.
2. If you are a member of a roadside assistance program, we recommend that you contact your roadside assistance service provider.
3. If this is not possible, wait for a short period of time for the engine to cool.
4. Check the coolant level. If the coolant level is at or below the minimum mark, add prediluted coolant immediately.
5. When the engine temperature cools, you can re-start the engine. Have your vehicle checked as soon as possible to minimize engine damage.

Note: *Driving your vehicle without repair increases the chance of engine damage.*

FAIL-SAFE COOLING INDICATORS



If the engine begins to overheat, the coolant temperature gauge moves toward the red zone.



A warning lamp illuminates and a message may appear in the instrument cluster display.

Towing Your Vehicle

TOWING YOUR VEHICLE PRECAUTIONS

Use the following guidelines when towing your vehicle. Failure to follow this instruction could result in vehicle damage not covered by the vehicle warranty.

Note: Make sure you properly secure your vehicle to the tow vehicle.

Note: If you are unsure of the vehicle's configuration, contact an authorized dealer.

EMERGENCY TOWING - BATTERY ELECTRIC VEHICLE

If your vehicle becomes inoperable without access to wheel dollies or a vehicle transport trailer, it can be flat-towed with all wheels on the ground, regardless of the drivetrain, under the following conditions:

- Your vehicle is facing forward for towing in a forward direction.
- You switch **Emergency Tow** on.
- Maximum speed is 30 mph (50 km/h).
- Maximum distance is 50 mi (80 km).

Switching Emergency Tow On

1. Properly secure your vehicle to the tow vehicle.
2. Switch your vehicle on to accessory mode. See **Starting and Powering Off** (page 180).
3. Apply the parking brake.
4. Using the instrument cluster display controls on the steering wheel, select **Settings**.
5. Select **Vehicle Settings**.
6. Select **Emergency Tow**.
7. Press and hold the **OK** button until a confirmation message appears in the instrument cluster display.

8. Press and hold the brake pedal.
9. Shift into neutral (N).

Note: A confirmation message appears in the instrument cluster display.

10. Release the parking brake.
11. Switch your vehicle off.

Switching Emergency Tow Off

1. Switch your vehicle on.
2. Press and hold the brake pedal.
3. Shift into park (P). A confirmation message appears in the instrument cluster display and the park (P) position illuminates on the transmission selector.

Emergency Equipment

STORING A FIRST AID KIT

You can store a first aid kit in the passenger side front door storage.

STORING A WARNING TRIANGLE

You can store a warning triangle in the driver side front door storage.

Fuses

FUSE PRECAUTIONS



WARNING: Always replace a fuse with one that has the specified amperage rating. Using a fuse with a higher amperage rating can cause severe wire damage and could start a fire.



WARNING: To reduce risk of electrical shock, always replace the cover to the power distribution box before reconnecting the battery or refilling fluid reservoirs.

UNDER HOOD FUSE BOX

ACCESSING THE UNDER HOOD FUSE BOX

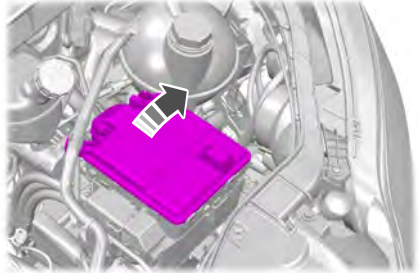

Fuses

IDENTIFYING THE FUSES IN THE UNDER HOOD FUSE BOX

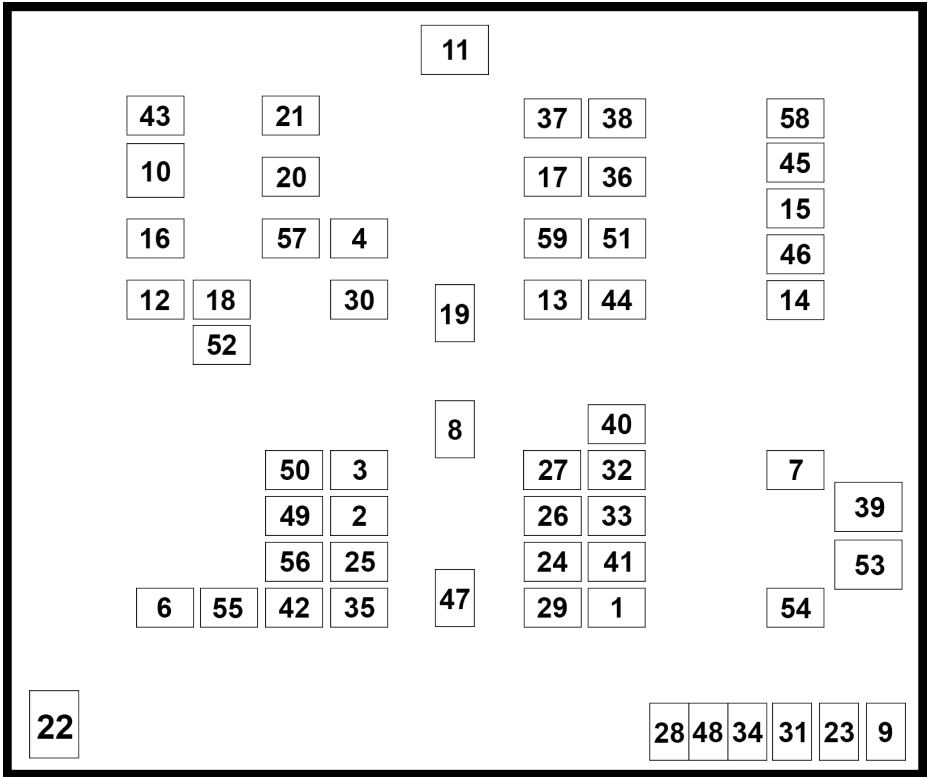

Item	Fuse Rating	Protected Component
1	-	Not used (Spare).
2	15 A	Reduction pump - Gasoline. Exhaust gas recirculation cooler bypass valve - Gasoline.

Fuses

Item	Fuse Rating	Protected Component
		Universal Exhaust Gas Oxygen Sensor - Gasoline.
3	15 A	Powertrain control module - Battery Electric Vehicle.
	20 A	Powertrain control module - Gasoline.
4	15 A	Powertrain control module - Gasoline.
5	-	Not used (Spare).
6	25 A	Cooling fan - Gasoline.
7	30 A	Starter motor - Gasoline.
8	-	Not used (Spare).
9	-	Not used (Spare).
10	40 A	Control module heater blower - Battery Electric Vehicle.
		Blower motor - Gasoline.
11	50 A	Windshield wipers.
12	40 A	Rear window defroster.
13	20 A	Fuel pump - Gasoline.
14	10 A	Left-hand headlamp.
15	10 A	Right-hand headlamp.
16	20 A	Horn.
17	-	Not used (Spare).
18	-	Not used (Spare).
19	40 A	Rear heater blower - Gasoline.
20	40 A	Not used (Spare).
21	40 A	All-wheel drive - Gasoline.
22	50 A	Cooling fan 2 - Gasoline.
	60 A	High-speed cooling fan - Gasoline. Resistor - Gasoline.
23	40 A	ABS/ESP control module.
24	10 A	Power inverter - Battery Electric Vehicle.

Fuses

Item	Fuse Rating	Protected Component
		On board generator inverter - Battery Electric Vehicle.
25	15 A	Positive temperature coefficient heater pump - Gasoline.
	10 A	Positive temperature coefficient heater valve - Gasoline. Air conditioning compressor.
26	5 A	Micro module power - Battery Electric Vehicle.
		Exhaust gas recirculation cooler bypass valve - Gasoline.
27	-	Not used (Spare).
28	5 A	Traction control module battery control - Battery Electric Vehicle.
29	5 A	Cooling fan - Battery Electric Vehicle.
30	15 A	Reductant tank - Gasoline. Particulate matter sensor - Gasoline.
31	-	Not used (Spare).
32	10 A	Powertrain control module - Battery Electric Vehicle.
	15 A	Automatic transmission module - Gasoline.
33	5 A	Powertrain control module - Gasoline.
34	5 A	Direct Current to Direct Current converter - Battery Electric Vehicle.
35	-	Not used (Spare).
36	5 A	Powertrain control module - Battery Electric Vehicle.
37	30 A	Trailer tow park - Gasoline.
38	10 A	Trailer tow backup - Gasoline.
39	60 A	Power distribution box - Battery Electric Vehicle.
		High-speed cooling fan - Gasoline.
40	5 A	Anti-lock Braking System.
41	10 A	Body control module battery charger - Battery Electric Vehicle.

Fuses

Item	Fuse Rating	Protected Component
42	-	Not used (Spare).
43	-	Not used (Spare).
44	40 A	Upfitter connector power - Battery Electric Vehicle.
		Run/Start relay 2 - Gasoline.
45	40 A	USB port.
46	40 A	USB port.
47	60 A	Cooling fan - Battery Electric Vehicle.
	50 A	Cooling fan - Gasoline.
48	-	Not used (Spare).
49	-	Not used (Spare).
50	-	Not used (Spare).
51	40 A	Electric vacuum pump - Battery Electric Vehicle.
52	10 A	Power folding mirrors.
53	60 A	ABS/ESP control module - Battery Electric Vehicle.
		ABS pump - Gasoline.
54	10 A	Air conditioning clutch - Gasoline.
55	30 A	Trailer tow socket - Gasoline.
56	-	Not used (Spare).
57	-	Not used (Spare).
58	15 A	Not used (Spare).
59	5 A	Body control module AC charger - Battery Electric Vehicle.

Fuses

INTERIOR FUSE BOX

ACCESSING THE INTERIOR FUSE BOX

Driver Compartment Fuse Box

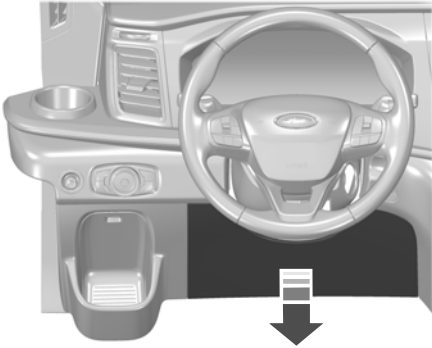

Passenger Compartment Fuse Box



Fuses

IDENTIFYING THE FUSES IN THE INTERIOR FUSE BOX

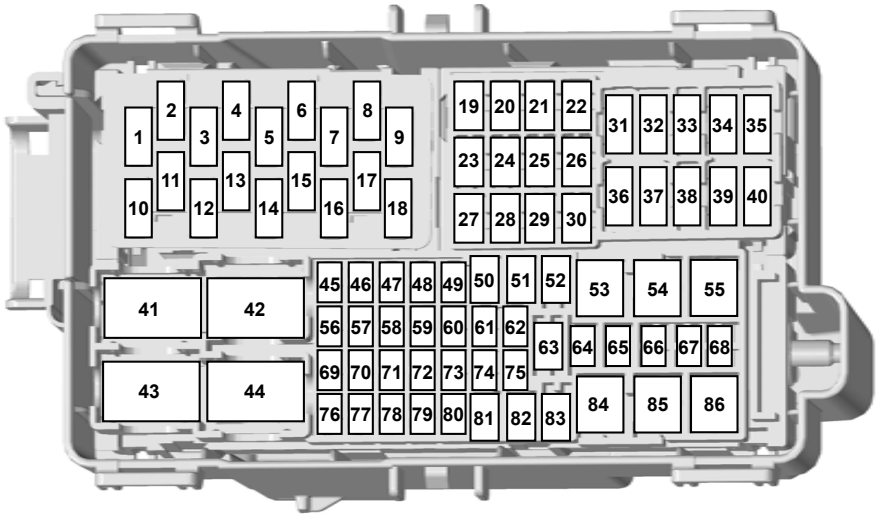

Driver Compartment Fuse Box

Item	Fuse Rating	Protected Component
1	5 A	USB port.
2	-	Not used.
3	5 A	USB port.
4	-	Not used.
5	-	Not used.
6	-	Not used.
7	-	Not used.
8	-	Not used.
9	10 A	Heated exterior mirrors.
10	5 A	Cooling fan.
11	-	Not used.

Fuses

Item	Fuse Rating	Protected Component
12	-	Not used.
13	-	Not used.
14	-	Not used.
15	-	Not used.
16	5 A	Rain sensor.
17	-	Not used.
18	20 A	Relay.
19	-	Not used.
20	-	Not used.
21	20 A	Heated rear window.
22	20 A	Heated rear window.
23	20 A	Auxiliary power point.
24	20 A	Auxiliary power point.
25	-	Not used.
26	25 A	Windshield wiper motor.
27	-	Not used.
28	30 A	Modified vehicle connections.
29	20 A	Not used (Spare).
30	30 A	Not used (Spare).
31	-	Not used.
32	-	Not used.
33	-	Not used.
34	-	Not used.
35	-	Not used.
36	-	Not used.
37	-	Not used.
38	-	Not used.

Fuses

Item	Fuse Rating	Protected Component
39	-	Not used.
40	-	Not used.
41	25 A	Load shed relay.
42	40 A	Starter relay.
43	40 A	Upfitter relay.
44	40 A	Starter relay.
45	10 A	Upfitter interface module.
46	-	Not used.
47	-	Not used.
48	5 A	Modified vehicle connections.
49	10 A	Brake pedal switch.
50	30 A	Passenger power seat.
51	40 A	Modified vehicle connections.
52	30 A	Driver power seat.
53	60 A	Battery.
54	60 A	Power inverter.
55	50 A	Body control module.
56	10 A	Modified vehicle connections.
57	-	Not used.
58	10 A	Upfitter interface. Secondary junction box.
59	10 A	Rear climate control. Front view camera. Rear view camera. Adaptive cruise control module. Blind spot information system.
60	10 A	Trailer brake control module.
61	-	Not used.
62	15 A	Upfitter interface module.

Fuses

Item	Fuse Rating	Protected Component
63	20 A	Auxiliary power point.
64	30 A	Modified vehicle connections.
65	-	Not used.
66	10 A	Load shed relay.
67	-	Not used.
68	5 A	Trailer tow module.
69	5 A	Steering wheel module.
70	5 A	Swivel seats.
71	10 A	Passenger heated seat.
72	10 A	Driver heated seat.
73	20 A	Not used (Spare).
74	5 A	Temperature sensor.
75	20 A	Engine compartment fuse box.
76	10 A	Not used (Spare).
77	5 A	Headlamp switch.
78	7.5 A	Modified vehicle connections.
79	5 A	Driver compartment fuse box relay.
80	10 A	Diagnostic connector.
81	40 A	Trailer tow module.
82	30 A	Not used (Spare).
83	30 A	Trailer brake control module.
84	50 A	Body control module.
85	30 A	Not used (Spare).
86	50 A	Body control module.

Fuses

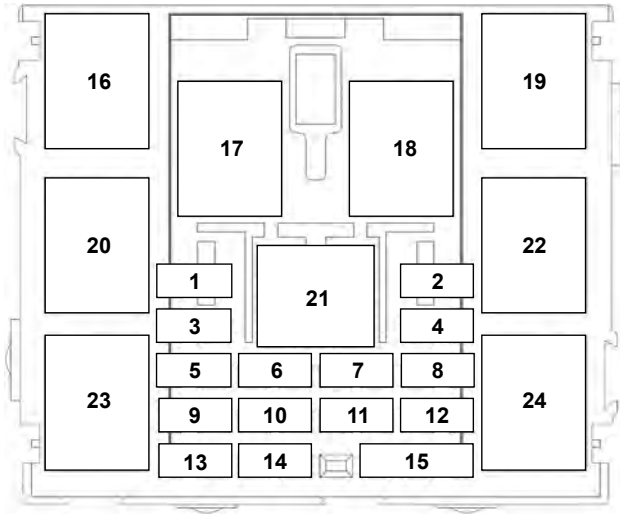

Passenger Compartment Fuse Box

Item	Fuse Rating	Protected Component
1	40 A	Relay 2.
2	40 A	Relay 3.
3	20 A	Relay 1.
4	20 A	Relay 4.
5	20 A	Relay 5.
6	-	Not used.
7	-	Not used.
8	20 A	Relay 7.
9	20 A	Relay 8.
10	-	Not used.
11	-	Not used.
12	20 A	Relay 9.

Fuses

Item	Fuse Rating	Protected Component
13	5 A	Relay 6.
14	5 A	Ignition.
15	5 A	Power supply.
16	20 A	Auxiliary switch 3 relay.
17	40 A	Auxiliary switch 3 relay.
18	40 A	Auxiliary switch 3 relay.
19	20 A	Auxiliary switch 4 relay.
20	20 A	Auxiliary switch 5 relay.
21	20 A	Auxiliary fuse box relay.
22	20 A	Auxiliary switch 7 relay.
23	20 A	Auxiliary switch 8 relay.
24	20 A	Auxiliary switch 9 relay.

BODY CONTROL MODULE FUSE BOX

ACCESSING THE BODY CONTROL MODULE FUSE BOX

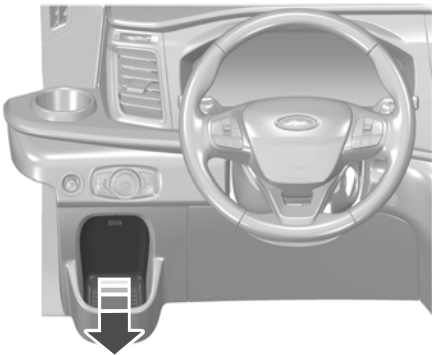

Fuses

IDENTIFYING THE FUSES IN THE BODY CONTROL MODULE FUSE BOX

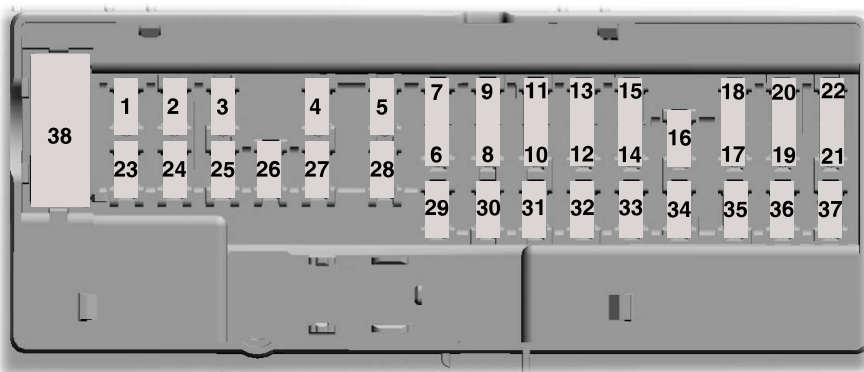

Item	Fuse Rating	Protected Component
1	-	Not used.
2	10 A	Power inverter.
3	7.5 A	Power window switch. Power exterior mirrors.
4	20 A	Not used.
5	-	Not used.
6	10 A	Security horn relay.
7	10 A	Not used.
8	5 A	Telematics control unit module.
9	5 A	Rear air conditioning. Interior scan.
10	-	Not used.
11	-	Not used.
12	7.5 A	Climate control.

Fuses

Item	Fuse Rating	Protected Component
13	7.5 A	Data link connector. Steering column. Instrument cluster.
14	15 A	Not used.
15	15 A	SYNC 3 module. Integrated control panel.
16	-	Not used.
17	7.5 A	Not used.
18	7.5 A	Not used.
19	5 A	Anti-theft alarm horn.
20	5 A	Ignition switch.
21	5 A	Positive temperature coefficient heater control.
22	5 A	Not used.
23	30 A	Not used.
24	30 A	Not used.
25	20 A	Driver door module.
26	30 A	Passenger door module.
27	30 A	Not used.
28	30 A	Not used.
29	15 A	Not used.
30	5 A	Not used.
31	10 A	Data link connector. Remote key receiver. Instrument cluster.
32	20 A	Radio.
33	-	Not used.
34	30 A	Run/Start relay.
35	5 A	Not used.
36	15 A	Parking aid.

Fuses

Item	Fuse Rating	Protected Component
		Steering column control module. Lane departure.
37	20 A	Not used.
38	30 A	Power windows.

HIGH CURRENT FUSE BOX

LOCATING THE HIGH CURRENT FUSE BOX

The high current fuse box is under the driver seat.

ACCESSING THE HIGH CURRENT FUSE BOX

Remove the trim panel.

IDENTIFYING THE FUSES IN THE HIGH CURRENT FUSE BOX

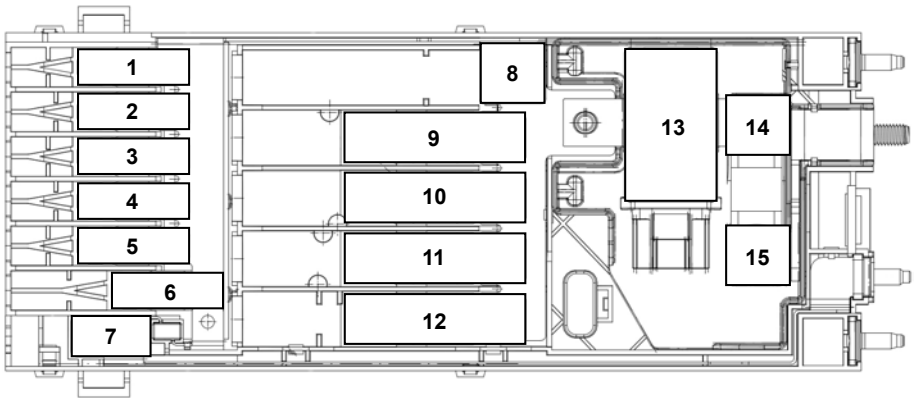

Fuses

Item	Fuse Rating	Protected Component
1	125 A	Body control module.
2	80 A	Electronic power assist steering.
3	150 A	Positive temperature coefficient heater.
4	-	Not used.
5	60 A	Cooling fan - Battery Electric Vehicle.
6	150 A	Passenger compartment fuse box.
7	60 A	Upfitter.
8	-	Not used.
9	500 A	Starter motor - Gasoline. Alternator - Gasoline.
	300 A	Direct Current to Direct Current converter - Battery Electric Vehicle.
10	300 A	Engine compartment fuse box.
11	250 A	Dual generators.
12	150 A	Driver compartment fuse box.
13	190 A	Load shed relay.
14	175 A	Auxiliary power point 1.
15	60 A	Auxiliary power point 2.

Fuses

IDENTIFYING FUSE TYPES

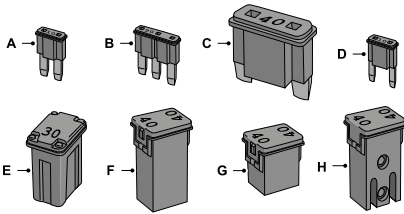

A	Micro 2.
B	Micro 3.
C	Maxi.
D	Mini.
E	M Case.
F	J Case.
G	J Case Low Profile.
H	Slotted M Case.

FUSES – TROUBLESHOOTING

FUSES – FREQUENTLY ASKED QUESTIONS

When do I need to check a fuse?

If electrical components in the vehicle are not working.

When do I need to replace a fuse?

If a fuse has blown.

How do I identify a blown fuse?

You can identify a blown fuse by a broken wire within the fuse.

Maintenance

MAINTENANCE PRECAUTIONS

Have your vehicle serviced regularly to help maintain its roadworthiness and resale value. There is a large network of authorized dealers that are there to help you with their professional servicing expertise. We believe that their specially trained technicians are best qualified to service your vehicle properly and expertly. They are supported by a wide range of highly specialized tools developed specifically for servicing your vehicle.

If your vehicle requires professional service, an authorized dealer can provide the necessary parts and service. Check your warranty information to find out which parts and services are covered.

Use only recommended fluids and service parts conforming to specifications.

If you do not use oil and fluid that meets the defined specification and viscosity grade, it could result in:

- Component damage not covered by the vehicle Warranty.
- Longer engine cranking periods.
- Increased emission levels.
- Reduced engine performance.
- Reduced fuel economy.
- Reduced brake performance.

OPENING AND CLOSING THE HOOD

Opening the Hood

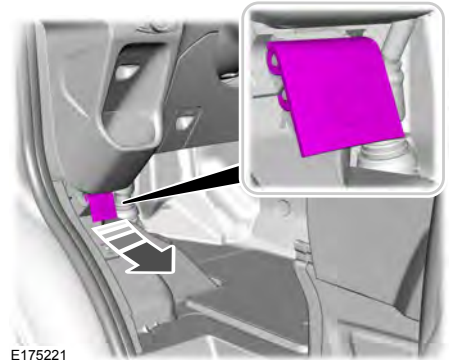

E175221

1. Pull the hood release lever.

Maintenance

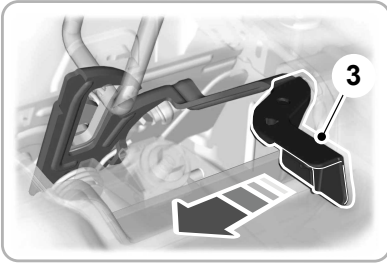
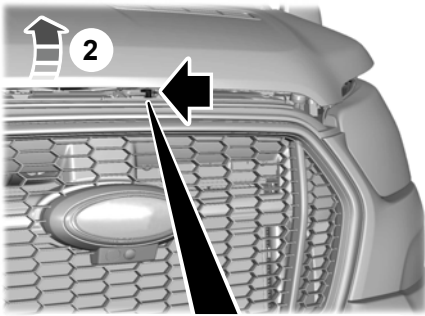

2. Slightly lift the hood.
3. Move the catch to the left.



E87786

4. Open the hood. Support the hood with the strut.

Closing the Hood

1. Remove the strut from the catch and secure it correctly in the clip.
2. Lower the hood and allow it to drop under its own weight for the last 8–12 in (20–30 cm).

Note: Make sure that the hood is correctly closed.

Maintenance

UNDER HOOD OVERVIEW - 3.5L DURATEC

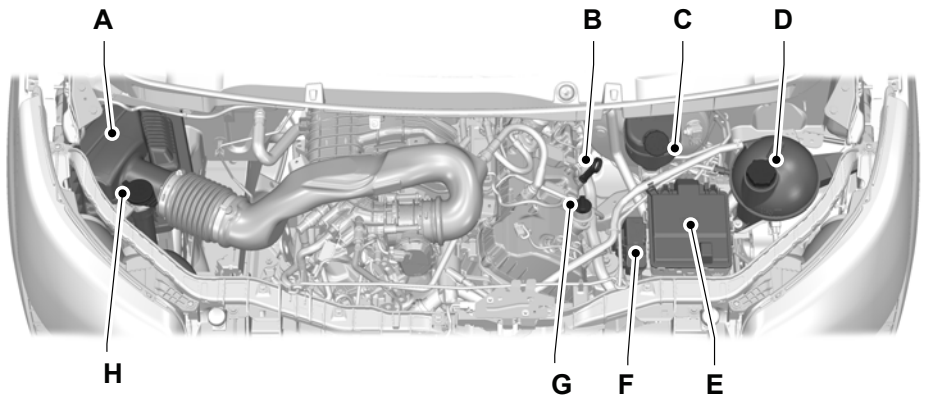

- A Air filter assembly.
- B Engine oil dipstick. See **Engine Oil Dipstick Overview** (page 370).
- C Brake fluid reservoir. See **Checking the Brake Fluid** (page 225).
- D Engine coolant reservoir. See **Checking the Coolant Level** (page 373).
- E Engine compartment fuse box. See **Under Hood Fuse Box** (page 349).
- F Battery connection. See **Jump Starting the Vehicle** (page 340).
- G Engine oil filler cap. See **Checking the Engine Oil Level** (page 370).
- H Washer fluid reservoir. See **Adding Washer Fluid** (page 103).

Maintenance

UNDER HOOD OVERVIEW - 3.5L ECOBOOST™

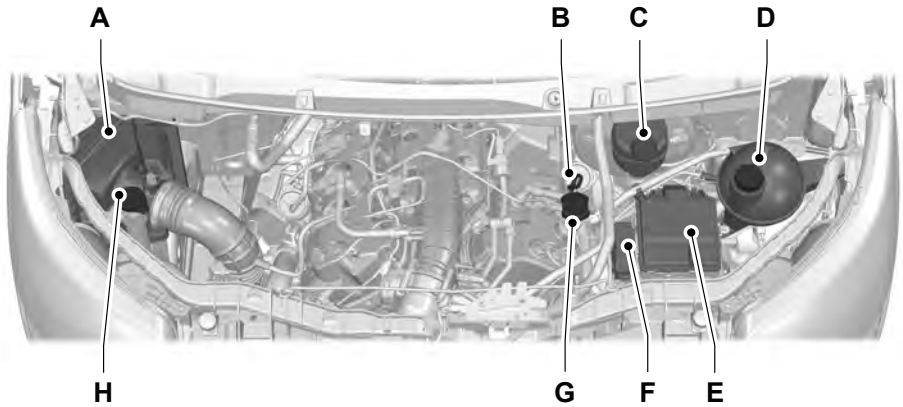

- A Air filter assembly.
- B Engine oil dipstick. See **Engine Oil Dipstick Overview** (page 370).
- C Brake fluid reservoir. See **Checking the Brake Fluid** (page 225).
- D Engine coolant reservoir. See **Checking the Coolant Level** (page 373).
- E Engine compartment fuse box. See **Under Hood Fuse Box** (page 349).
- F Battery connection. See **Jump Starting the Vehicle** (page 340).
- G Engine oil filler cap. See **Checking the Engine Oil Level** (page 370).
- H Washer fluid reservoir. See **Adding Washer Fluid** (page 103).

Maintenance

UNDER HOOD OVERVIEW - BATTERY ELECTRIC VEHICLE

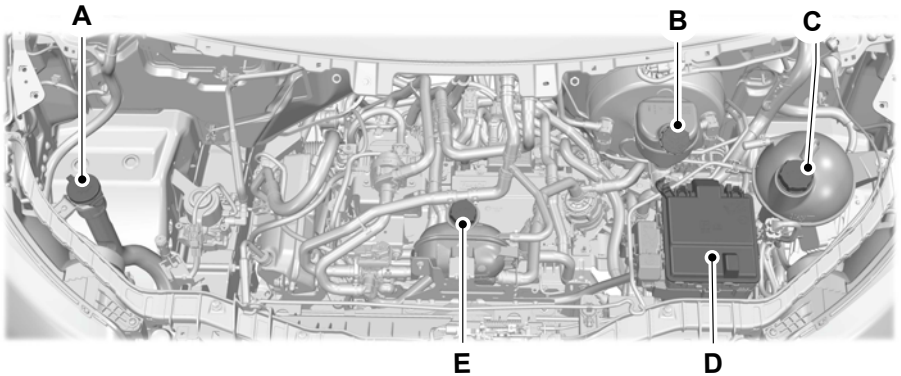

- A Washer system fluid reservoir. See **Adding Washer Fluid** (page 103).
- B Brake fluid reservoir. See **Checking the Brake Fluid** (page 225).
- C High temperature coolant reservoir. See **Checking the Coolant Level** (page 373).
- D Under hood fuse box. See **Under Hood Fuse Box** (page 348).
- E Low temperature coolant reservoir. See **Checking the Coolant Level** (page 373).

Maintenance

ENGINE OIL - GASOLINE

ENGINE OIL DIPSTICK OVERVIEW

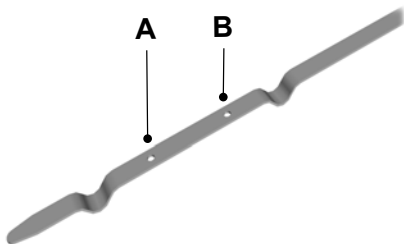

E174604

- A Minimum.
- B Maximum.

CHECKING THE ENGINE OIL LEVEL

1. Make sure that your vehicle is on level ground.
2. Check the oil level before starting the engine, or switch the engine off after warm up and wait 15 minutes for the oil to drain into the oil pan.

Note: *Checking the oil level too soon could result in an inaccurate reading.*

3. Remove the dipstick and wipe it with a clean, lint-free cloth.
4. Reinstall the dipstick and make sure it is fully seated.
5. Remove the dipstick again to check the oil level.

Note: *Read both sides of the dipstick and use the lowest oil level as the correct reading.*

Note: *If the oil level is between the maximum and minimum marks, the oil level is acceptable. Do not add oil.*

6. If the oil level is at the minimum mark, immediately add oil.
7. Reinstall the dipstick. Make sure it is fully seated.

Note: *The oil consumption of new engines reaches its normal level after approximately 3,000 mi (5,000 km).*

Note: *Increases in oil level can occur from frequent short trips that do not allow the engine to get to operating temperature, as well as frequent idling or low speed driving for long periods of time.*

Note: *If oil levels are continuously noted above the maximum mark, have your vehicle checked as soon as possible.*

ADDING ENGINE OIL



WARNING: Do not remove the filler cap when the engine is running.



WARNING: Do not add engine oil when the engine is hot. Failure to follow this instruction could result in personal injury.

Do not use supplemental engine oil additives because they are unnecessary and could lead to engine damage that the vehicle warranty may not cover.

1. Clean the area surrounding the engine oil filler cap before you remove it.
2. Remove the engine oil filler cap.
3. Add engine oil that meets our specifications. See **Capacities and Specifications** (page 452).
4. Reinstall the engine oil filler cap. Turn it clockwise until you feel a strong resistance.

Note: *Do not add oil further than the maximum mark. Oil levels above the maximum mark may cause engine damage.*

Maintenance

Note: *Immediately soak up any oil spillage with an absorbent cloth.*

INTELLIGENT OIL LIFE MONITOR

Under certain conditions the vehicle's intelligent oil life monitor may determine that your oil requires replacement prior to your general service. Should this occur it is recommended you replace your oil within two weeks or 500 mi (800 km) of being alerted.

Your authorized dealer will be able to advise you whether only an engine oil and filter change is recommended or whether you should complete your general service inclusive of oil and oil Filter.

Checking the Current State of Oil Life

You can check the current state of oil life in percentage.

1. Press the menu button on the steering wheel to enter the instrument cluster display main menu.
2. Select **Settings**.
3. Select **Oil Life**.

RESETTING THE INTELLIGENT OIL LIFE MONITOR

Only reset the oil life monitoring system after changing the engine oil and oil filter.

1. Press the menu button on the steering wheel to enter the instrument cluster display main menu.
2. Select **Settings**.
3. Select **Oil Life**.
4. Press and hold the **OK** button until the system reset confirmation appears.

ENGINE OIL – INFORMATION MESSAGES

Message	Action
Change Engine Oil Soon	Displays when the engine oil life is becoming depleted. Have the engine oil changed as soon as possible.
Oil Change Required	Displays when the engine oil life is depleted. Have the engine oil changed as soon as possible.
Oil Level Low Add Oil	Displays when the engine oil level is too low. Add engine oil as soon as possible. See Adding Engine Oil (page 370).

Maintenance

ENGINE AIR FILTER - GASOLINE

CHANGING THE ENGINE AIR FILTER



WARNING: To reduce the risk of vehicle damage and personal burn injuries, do not start your engine with the air cleaner removed and do not remove it while the engine is running.

Note: Failure to use the correct air filter element may result in severe engine damage. Resulting component damage may not be covered by the vehicle Warranty.

Only use the specified air filter. See **Capacities and Specifications** (page 452).

Change the air filter element at the correct service interval. See **Scheduled Maintenance** (page 524).

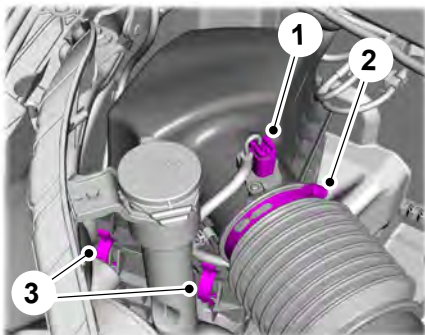

E174607

1. Disconnect the intake air temperature sensor electrical connector and cable from the air filter cover.

2. Clean the area around the air tube to air filter cover connection to prevent debris from entering the system and then loosen the bolt on the air tube clamp so the clamp is no longer snug to the air tube. It is not necessary to completely remove the clamp. Pull the air tube off from the air filter cover.
3. Release the clamps that secure the air filter cover to the air filter housing.

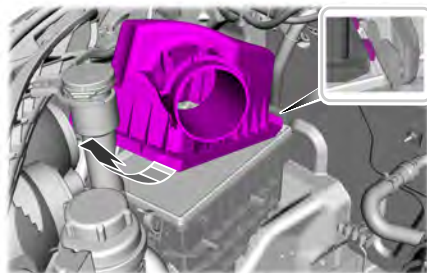

E174669

4. Carefully lift the air filter housing cover. Remove the air filter element from the air filter housing.
5. Install a new air filter element.
6. Replace the air filter housing cover. Engage the clamps that secure the air filter housing cover to the air filter housing. Be careful not to crimp the filter element edges between the air filter housing and cover. Make sure that the tabs on the edge are correctly aligned into the slots.
7. Slip the air tube onto the air filter cover and firmly tighten the bolt on the air tube clamp, but do not overtighten.
8. Reconnect the intake air temperature sensor electrical connector to the outlet tube. Make sure the locking tab on the connector is in the locked position.

Maintenance

ENGINE AIR FILTER – INFORMATION MESSAGES

Message	Action
Filter OK	Indicates the engine air filter is performing as expected.
Check Filter See Manual	Indicates that there is a higher than expected restriction across the engine air filter, which could represent an air filter at full useful life or a filter with an obstruction. When this displays, inspect the engine air filter and replace if necessary. After the inspection or engine air filter replacement, you must reset the system in order to change the status from Check Filter to Filter OK.
System Fault See Manual	Indicates that there is an error within the electronic air filter maintenance minder system requiring service.

ENGINE COOLING FAN - GASOLINE



WARNING: Keep your hands and clothing clear of the engine cooling fan.

Under certain conditions, the engine cooling fan may continue to run for several minutes after you switch your vehicle off.

COOLANT - GASOLINE

CHECKING THE COOLANT LEVEL



WARNING: Do not remove the coolant reservoir cap when the engine is on or the cooling system is hot. Wait 10 minutes for the cooling system to cool down. Cover the coolant reservoir cap with a thick cloth to prevent the possibility of scalding and slowly remove the cap. Failure to follow this instruction could result in personal injury.



WARNING: To reduce the risk of personal injury, make sure the engine is cool before unscrewing the coolant pressure relief cap. The cooling system is under pressure. Steam and hot liquid can come out forcefully when you loosen the cap slightly.

When the engine is cold, check the concentration and level of the coolant at the intervals listed in the scheduled maintenance information. See **Scheduled Maintenance** (page 524).

Note: Make sure that the coolant level is between the **MIN** and the **MAX** marks on the coolant reservoir.

Note: Coolant expands when it is hot. The level may extend beyond the **MAX** mark. This is normal.

Maintain coolant concentration within 48% to 50%, which equates to a freeze point between -29°F (-34°C) and -35°F (-37°C). Coolant concentration should be checked using a refractometer. We do not recommend the use of hydrometers or coolant test strips for measuring coolant concentration.

Maintenance

ADDING COOLANT



WARNING: Do not add coolant when the vehicle is on or the cooling system is hot. Failure to follow this instruction could result in personal injury.



WARNING: Do not remove the coolant reservoir cap when the engine is on or the cooling system is hot. Wait 10 minutes for the cooling system to cool down. Cover the coolant reservoir cap with a thick cloth to prevent the possibility of scalding and slowly remove the cap. Failure to follow this instruction could result in personal injury.



WARNING: Do not allow the fluid to touch your skin or eyes. If this happens, rinse the affected areas immediately with plenty of water and contact your physician.



WARNING: Do not put coolant in the windshield washer reservoir. If sprayed on the windshield, coolant could make it difficult to see through the windshield.



WARNING: Do not add coolant further than the **MAX** mark.



WARNING: Undiluted coolant is flammable and may ignite if spilled on a hot exhaust.



WARNING: Do not dispose of coolant in the household refuse or the public sewage system. Use an authorized waste disposal facility.

Note: Do not use stop leak pellets, cooling system sealants, or non-specified additives as they can cause damage to the engine cooling or heating systems. Resulting component damage may not be covered by the vehicle Warranty.

Note: Automotive fluids are not interchangeable.

It is very important to use prediluted coolant approved to the correct specification in order to avoid plugging the small passageways in the engine cooling system. See **Capacities and Specifications** (page 452). Do not mix different colors or types of coolant in your vehicle. Mixing of engine coolants or using an incorrect coolant may harm the engine or cooling system components and may not be covered by the vehicle Warranty.

Note: If prediluted coolant is not available, use the approved concentrated coolant diluting it to 50/50 with deionised or distilled water. See **Capacities and Specifications** (page 452). Using water that has not been deionised may contribute to deposit formation, corrosion and plugging of the small cooling system passageways.

Note: Coolants marketed for all makes and models may not be approved to our specifications and may cause damage to the cooling system. Resulting component damage may not be covered by the vehicle Warranty.

If the coolant level is at or below the minimum mark, add prediluted coolant immediately.

To top up the coolant level do the following:

1. Unscrew the cap slowly. Any pressure escapes as you unscrew the cap.
2. Add prediluted coolant approved to the correct specification. See **Capacities and Specifications** (page 452).
3. Add enough prediluted coolant to reach the correct level.
4. Replace the coolant reservoir cap. Turn the cap clockwise until it contacts the hard stop.

Maintenance

5. Check the coolant level in the coolant reservoir the next few times you drive your vehicle. If necessary, add enough prediluted engine coolant to bring the coolant level to the correct level.

If you have to add more than 1.1 qt (1 L) of engine coolant per month, have your vehicle checked as soon as possible. Operating an engine with a low level of coolant can result in engine overheating and possible engine damage.

In case of emergency, you can add a large amount of water without engine coolant in order to reach a vehicle service location.

Water alone, without engine coolant, can cause engine damage from corrosion, overheating or freezing.

Do not use the following as a coolant substitute:

- Alcohol.
- Methanol.
- Brine.
- Any coolant mixed with alcohol or methanol antifreeze.

Alcohol and other liquids can cause engine damage from overheating or freezing.

Do not add extra inhibitors or additives to the coolant. These can be harmful and compromise the corrosion protection of the coolant.

CHANGING THE COOLANT

For coolant change, see your authorized dealer.

Changing the coolant is necessary at specific mileage intervals listed in the scheduled maintenance information. See **Scheduled Maintenance** (page 524).

MANAGING THE COOLANT TEMPERATURE

If you tow a trailer with your vehicle, the engine may temporarily reach a higher temperature during severe operating conditions, for example ascending a long or steep grade in high ambient temperatures.

At this time, you may notice the coolant temperature gauge moves toward the red zone and a message may appear in the information display.



WARNING: To reduce the risk of crash and injury, be prepared that the vehicle speed may reduce and the vehicle may not be able to accelerate with full power until the coolant temperature reduces.



WARNING: If you continue to drive your vehicle when the engine is overheating, the engine could stop without warning. Failure to follow this instruction could result in the loss of control of your vehicle.

You may notice a reduction in vehicle speed caused by reduced engine power in order to manage the engine coolant temperature. Your vehicle may enter this mode if certain high-temperature and high-load conditions take place. The amount of speed reduction depends on vehicle loading, grade and outside temperature. If this occurs, there is no need to stop your vehicle. You can continue to drive. See **Fail-Safe Cooling** (page 344).

Maintenance

The air conditioning may automatically turn on and off during severe operating conditions to protect the engine from overheating. When the coolant temperature decreases to the normal operating temperature, the air conditioning turns on.

If the coolant temperature gauge moves fully into the red zone, or if the coolant temperature warning or service engine soon messages appear in your information display, do the following:

1. Stop your vehicle as soon as it is safe to do so. Fully apply the parking brake, shift into park (P) or neutral (N).
2. Leave the engine running until the coolant temperature gauge needle returns to the normal position. If the temperature does not drop after several minutes, follow the remaining steps.

3. Switch the engine off and wait for it to cool. Check the coolant level.
4. If the coolant level is at or below the minimum mark, add prediluted coolant immediately.
5. If the coolant level is normal, restart the engine and continue.

COOLANT – WARNING LAMPS



If the engine begins to overheat, the coolant temperature gauge moves toward the red zone.



A warning lamp illuminates and a message may appear in the information display.

COOLANT – INFORMATION MESSAGES

Message	Description and Action
High engine temperature Stop safely	Displays when the engine temperature is too high. Stop your vehicle as soon as it is safe to do so, switch the engine off and allow it to cool. If the problem persists, have your vehicle checked as soon as possible. See Checking the Coolant Level (page 373).

Maintenance

COOLANT - BATTERY ELECTRIC VEHICLE

CHECKING THE COOLANT LEVEL



WARNING: Do not remove the coolant reservoir cap when the vehicle is on or the cooling system is hot. Wait 10 minutes for the cooling system to cool down. Cover the coolant reservoir cap with a thick cloth to prevent the possibility of scalding and slowly remove the cap. Failure to follow this instruction could result in personal injury.



WARNING: To reduce the risk of personal injury, make sure the engine is cool before unscrewing the coolant pressure relief cap. The cooling system is under pressure. Steam and hot liquid can come out forcefully when you loosen the cap slightly.

When the electric motor is cold, check the concentration and level of the coolant at the intervals listed in the scheduled maintenance information. See **Scheduled Maintenance** (page 524).

Note: Make sure that the coolant level is between the **MIN** and the **MAX** marks on the coolant reservoir.

Note: Coolant expands when it is hot. The level may extend beyond the **MAX** mark. This is normal.

Maintain coolant concentration within 48% to 50%, which equates to a freeze point between -29°F (-34°C) and -35°F (-37°C). Coolant concentration should be checked using a refractometer. We do not recommend the use of hydrometers or coolant test strips for measuring coolant concentration.

ADDING COOLANT



WARNING: Do not add coolant when the vehicle is on or the cooling system is hot. Failure to follow this instruction could result in personal injury.



WARNING: Do not remove the coolant reservoir cap when the vehicle is on or the cooling system is hot. Wait 10 minutes for the cooling system to cool down. Cover the coolant reservoir cap with a thick cloth to prevent the possibility of scalding and slowly remove the cap. Failure to follow this instruction could result in personal injury.



WARNING: Do not allow the fluid to touch your skin or eyes. If this happens, rinse the affected areas immediately with plenty of water and contact your physician.



WARNING: Do not put coolant in the windshield washer reservoir. If sprayed on the windshield, coolant could make it difficult to see through the windshield.



WARNING: Do not add coolant further than the **MAX** mark.

Note: Do not use stop leak pellets, cooling system sealants, or non-specified additives as they can cause damage to the engine cooling or heating systems. Resulting component damage may not be covered by the vehicle Warranty.

Note: Automotive fluids are not interchangeable.

It is very important to use prediluted coolant approved to the correct specification in order to avoid plugging the small passageways in the electric motor cooling system. See **Capacities and Specifications** (page 452). Do not mix

Maintenance

different colors or types of coolant in your vehicle. Mixing of coolants or using an incorrect coolant may harm the electric motor or cooling system components and may not be covered by the vehicle Warranty.

Note: *If prediluted coolant is not available, use the approved concentrated coolant diluting it to 50/50 with deionized or distilled water. See **Capacities and Specifications** (page 452). Using water that has not been deionized may contribute to deposit formation, corrosion and plugging of the small cooling system passageways.*

Note: *Coolants marketed for all makes and models may not be approved to our specifications and may cause damage to the cooling system. Resulting component damage may not be covered by the vehicle Warranty.*

If the coolant level is at or below the minimum mark, add prediluted coolant immediately.

To top up the coolant level do the following:

1. Unscrew the cap slowly. Any pressure escapes as you unscrew the cap.
2. Add prediluted coolant approved to the correct specification. See **Capacities and Specifications** (page 452).
3. Add enough prediluted coolant to reach the correct level.
4. Replace the coolant reservoir cap. Turn the cap clockwise until it contacts the hard stop.
5. Check the coolant level in the coolant reservoir the next few times you drive your vehicle. If necessary, add enough prediluted coolant to bring the coolant level to the correct level.

If you have to add more than 1.1 qt (1 L) of coolant per month, have your vehicle checked as soon as possible. Operating your vehicle with a low level of coolant can result in overheating and possible electric motor damage.

In case of emergency, you can add a large amount of water without coolant in order to reach a vehicle service location.

Water alone, without coolant, can cause damage from corrosion, overheating or freezing.

Do not use the following as a coolant substitute:

- Alcohol.
- Methanol.
- Brine.
- Any coolant mixed with alcohol or methanol antifreeze.

Alcohol and other liquids can cause damage from overheating or freezing.

Do not add extra inhibitors or additives to the coolant. These can be harmful and compromise the corrosion protection of the coolant.

CHANGING THE COOLANT

For coolant change, see your authorized dealer.

Changing the coolant is necessary at specific mileage intervals listed in the scheduled maintenance information. See **Scheduled Maintenance** (page 524).

Maintenance

MANAGING THE COOLANT TEMPERATURE

If you tow a trailer with your vehicle, the electric motor may temporarily reach a higher temperature during severe operating conditions, for example ascending a long or steep grade in high ambient temperatures.

At this time, you may notice the coolant temperature gauge moves toward the red zone and a message may appear in the information display.



WARNING: To reduce the risk of crash and injury, be prepared that the vehicle speed may reduce and the vehicle may not be able to accelerate with full power until the coolant temperature reduces.



WARNING: If you continue to drive your vehicle when the engine is overheating, the engine could stop without warning. Failure to follow this instruction could result in the loss of control of your vehicle.

You may notice a reduction in vehicle speed caused by reduced electric motor power in order to manage the coolant temperature. Your vehicle may enter this mode if certain high-temperature and high-load conditions take place. The amount of speed reduction depends on vehicle loading, grade and outside temperature. If this occurs, there is no need to stop your vehicle. You can continue to drive. See **Fail-Safe Cooling** (page 344).

The air conditioning may automatically turn on and off during severe operating conditions to protect the electric motor from overheating. When the coolant temperature decreases to the normal operating temperature, the air conditioning turns on.

If the coolant temperature gauge moves fully into the red zone, or if the temperature warning or stop safely messages appear in your information display, do the following:

1. Stop your vehicle as soon as it is safe to do so.
2. Fully apply the parking brake, shift into park (P) or neutral (N).
3. Leave the vehicle powered on until the coolant temperature gauge needle returns to the normal position. If the temperature does not drop after several minutes, follow the remaining steps.
4. Power the vehicle off and wait for it to cool.
5. Check the coolant level.
6. If the coolant level is at or below the minimum mark, add prediluted coolant immediately.
7. If the coolant level is normal, restart the vehicle and continue.

COOLANT – WARNING LAMPS



If the electric motor or high voltage battery begins to overheat, the coolant temperature gauge moves toward the red zone.

Maintenance

COOLANT – INFORMATION MESSAGES

Message	Description and Action
Stop Safely Now	Displays when the coolant or high voltage battery temperature is too high. Stop your vehicle as soon as it is safe to do so, power the vehicle off and allow it to cool. If the problem persists, have your vehicle checked as soon as possible. See Managing the Coolant Temperature (page 379).
Limited Performance Due to hot battery	Displays if your vehicle has limited performance due to a hot high voltage battery. Drive with caution. Keep your vehicle connected to a charging system when not in use to maintain battery temperature. If the problem persists, have your vehicle checked as soon as possible.
Severely Limited Performance Due to hot battery	

12V BATTERY

12V BATTERY PRECAUTIONS



WARNING: Batteries normally produce explosive gases which can cause personal injury. Therefore, do not allow flames, sparks or lighted substances to come near the battery. When working near the battery, always shield your face and protect your eyes. Always provide correct ventilation.



WARNING: When lifting a plastic-cased battery, excessive pressure on the end walls could cause acid to flow through the vent caps, resulting in personal injury and damage to the vehicle or battery. Lift the battery with a battery carrier or with your hands on opposite corners.



WARNING: Keep batteries out of reach of children. Batteries contain sulfuric acid. Avoid contact with skin, eyes or clothing. Shield your eyes when working near the battery to protect against possible splashing of acid solution. In case of acid contact with skin or eyes, flush immediately with water for a minimum of 15 minutes and get prompt medical attention. If acid is swallowed, call a physician immediately.



WARNING: Battery posts, terminals and related accessories contain lead and lead compounds, chemicals known to the State of California to cause cancer and reproductive harm. **Wash your hands after handling.**

Maintenance



WARNING: This vehicle may have more than one battery. Removing the battery cables from only one battery does not disconnect your vehicle electrical system. Make sure you disconnect the battery cables from all batteries when disconnecting power. Failure to do so may cause serious personal injury or property damage.



WARNING: For vehicles with Auto-Start-Stop the battery requirement is different. You must replace the battery with one of exactly the same specification.

WHAT IS THE BATTERY MANAGEMENT SYSTEM

The battery management system monitors battery conditions and takes actions to extend battery life.

HOW DOES THE BATTERY MANAGEMENT SYSTEM WORK

If excessive battery drain is detected, the system temporarily disables some electrical systems to protect the battery.

Systems included are:

- Heated rear window.
- Heated seats.
- Climate control.
- Heated steering wheel.
- Audio unit.
- Navigation system.

A message could appear in the information display to alert you that battery protection actions are active. This message is only for notification that an action is taking place, and not intended to indicate an electrical problem or that the battery requires replacement.

BATTERY MANAGEMENT SYSTEM LIMITATIONS

After battery replacement, or in some cases after charging the battery with an external charger, the battery management system requires eight hours of vehicle sleep time to relearn the battery state of charge. During this time, your vehicle must remain fully locked with the ignition switched off.

Note: Prior to relearning the battery state of charge, the battery management system could temporarily disable some electrical systems.

Electrical Accessory Installation

To make sure the battery management system works correctly, do not connect an electrical device ground connection directly to the battery negative post. This can cause inaccurate measurements of the battery condition and potential incorrect system operation.

Note: If you add electrical accessories or components to the vehicle, it could adversely affect battery performance and durability. This could also affect the performance of other electrical systems in the vehicle.

CHANGING THE 12V BATTERY - GASOLINE

The battery is under the driver seat.

Note: If you have power seats and the battery has no charge, jump-start your vehicle to move the seat. See **Jump Starting the Vehicle** (page 339).

Maintenance

Removing the Battery

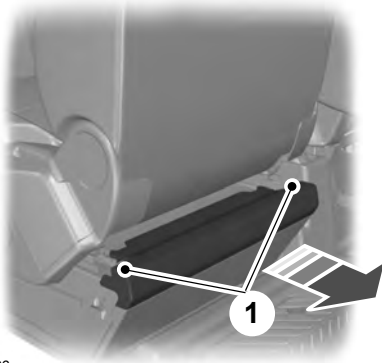

E152526

1. Fully raise the driver seat and move it fully forward. Pull the tabs upward and remove the cover.

Note: Your vehicle may not have this cover.

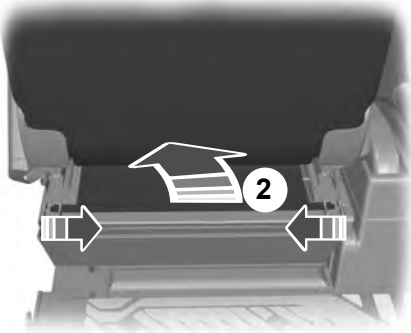

E152529

2. Unhook the cover and tuck it under the seat.

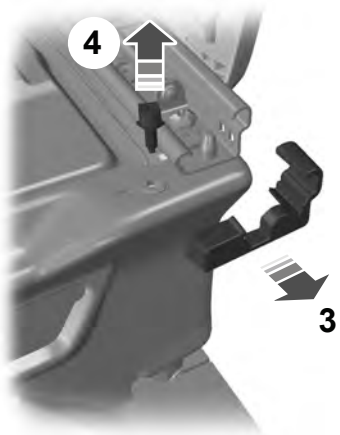

E146781

3. Remove both seat track end caps.

Note: Your vehicle may not have these end caps.

4. Remove both seat adjustment end stop bolts at the front of the seat.

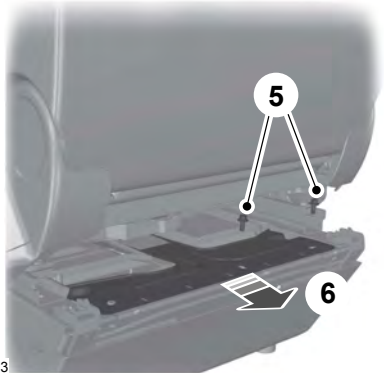

E146773

5. Remove the battery clamp and cover bolts.
6. Remove the battery clamp and cover.

Maintenance

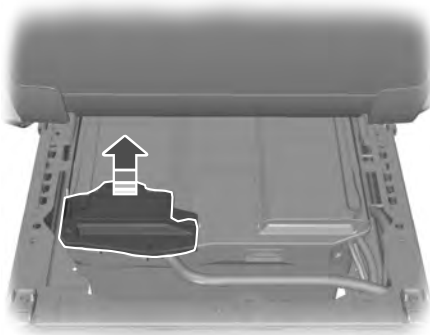

E162774

7. Remove the battery terminal cover and remove the negative (-) terminal.

Note: Single batteries could be mounted the opposite way around in the battery tray. The negative terminal is toward the rear of your vehicle.

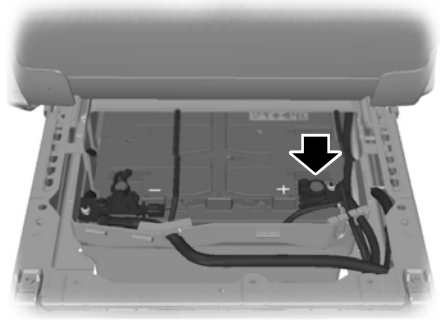

E162776

10. Remove the positive (+) terminal and remove the battery.

Note: Batteries are heavy.

11. Move the second battery toward the rear of your vehicle and remove the negative (-) terminal.
12. Remove the positive (+) terminal and remove the battery.

Replacing the Battery

 **WARNING:** Make sure that you securely fasten the seat runner bolts before installing the covers.

You must replace the battery with one of exactly the same specification.

To install, reverse the removal procedure.

Note: Make sure that you correctly install the battery terminal covers, battery cover and battery cable clips.

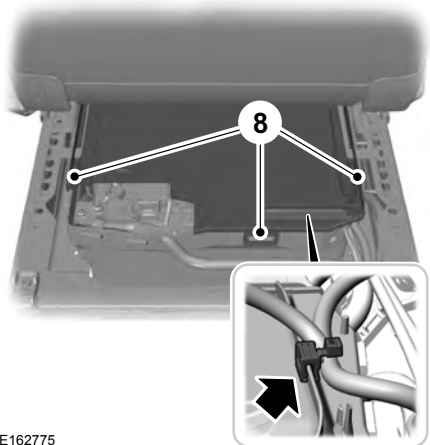

E162775

8. Release the retaining clips and remove the cover.
9. Remove the cable securing clips from the cover.

CHANGING THE 12V BATTERY - BATTERY ELECTRIC VEHICLE

If the 12 volt battery needs servicing, see your authorized dealer.

Maintenance

RESETTING THE BATTERY SENSOR

When you install a new battery, reset the battery sensor by doing the following:

1. Switch the ignition on, and leave the engine off.

Note: Complete Steps 2 and 3 within 10 seconds.

2. Flash the high beam headlamps five times, ending with the high beams off.
3. Press and release the brake pedal three times.

The battery warning lamp flashes three times to confirm that the reset is successful.

RECYCLING AND DISPOSING OF THE 12V BATTERY



Make sure that you dispose of old batteries in an environmentally friendly way.

Seek advice from your local authority about recycling old batteries.

CHARGING THE 12V BATTERY - BATTERY ELECTRIC VEHICLE

Your vehicle has a high voltage to low voltage energy transfer feature that keeps the 12-volt battery charged by the high voltage battery. If the 12-volt battery level is low, the high voltage battery transfers energy to the 12-volt battery when the vehicle is off.

12-volt battery depletion can still occur if the high voltage battery state of charge is low. See **Preserving Your High Voltage Battery** (page 191).

Always take care not to deep discharge the 12-volt battery as it may cause premature wear.

12V BATTERY – TROUBLESHOOTING - GASOLINE

12V BATTERY – WARNING LAMPS



If it illuminates while driving, it indicates a charging system error. Switch off all unnecessary electrical equipment and have your vehicle immediately checked.

12V BATTERY – INFORMATION MESSAGES

Message	Details
Check Charging System	The charging system needs servicing. If the warning stays on or continues to come on, have your vehicle checked as soon as possible.
Charging System Service Soon	The charging system needs servicing. If the warning stays on or continues to come on, have your vehicle checked as soon as possible.
Charging System Service Now	The charging system needs servicing. Have your vehicle immediately checked.

Maintenance

Message	Details
Battery State of Charge Low	The battery management system determines that the 12V battery is at a low state of charge. Start the engine to charge the battery or charge the battery using an aftermarket battery charger. Always use the vehicle ground point when connecting the negative cable of the external battery charger. See Jump Starting the Vehicle (page 340). This message clears once you restart your vehicle and the battery state of charge has recovered. Do not switch on the ignition when a battery charger is in use to charge the battery.
Turn Power Off To Save Battery	The battery management system determines that the battery is at a low state of charge. Turn the ignition off as soon as possible to protect the battery. This message will clear once the vehicle has been started and the battery state of charge has recovered. Turning off unnecessary electrical loads will allow faster battery state-of-charge recovery.
Electrical Power Saver Active Some Features Turned Off See Manual	Displayed when the battery management system detects an extended low-voltage condition. Various vehicle features will be disabled to help preserve the battery. Turn off as many of the electrical loads as soon as possible to improve system voltage. If the system voltage has recovered, the disabled features will operate again as normal.

12V BATTERY – TROUBLESHOOTING - BATTERY ELECTRIC VEHICLE

12V BATTERY – WARNING LAMPS



If it illuminates when the green ready to drive indicator is activated, this indicates your vehicle requires service. Have your vehicle checked as soon as possible.

Maintenance

12V BATTERY – INFORMATION MESSAGES

Message	Action
12V Battery Fault Service Soon	Your vehicle has a 12 volt battery problem. We recommend having the battery system checked by an authorized EV dealer.
Electric Range Reduced due to Park/Hazard Lamps On While Vehicle Off	The electric vehicle range is reduced due to the park and/or hazard lamps on while your vehicle was off.
Electrical System Drain Service Required	Your vehicle has an electrical drain within the vehicle. Please check for any after-market devices that could be draining the battery. If none are found, please have your vehicle serviced by an authorized EV dealer.

ADJUSTING THE HEADLAMPS

Vertical Aim Adjustment

If your vehicle has been involved in a crash, have the aim of the headlamp beam checked by an authorized dealer.

Headlamp Aiming Target

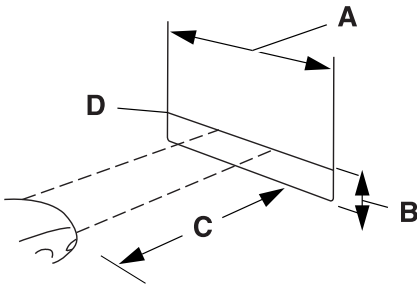

- A 8 ft (2.4 m)
- B Ground to the center of the headlamp low beam bulb

- C 25 ft (7.6 m)
- D Horizontal reference line

Vertical Aim Adjustment Procedure

1. Park your vehicle on level ground approximately 25 ft (7.6 m) from a wall or screen.
2. Measure the distance from the ground to the center of the headlamp low beam bulb and mark an 8 ft (2.4 m) long horizontal reference line on the wall or screen at this height.

Maintenance

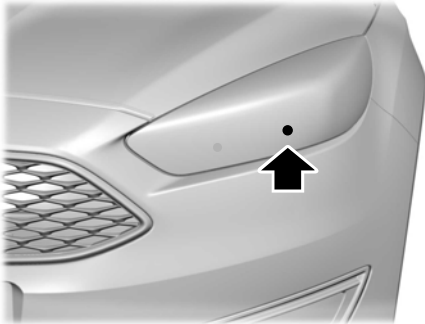

E199411

Note: There may be an identifying mark on the lens to help you locate the center of the bulb.

Note: To see a clearer light pattern while adjusting one headlamp, you may want to block the light from the other headlamp.

3. Switch on the low beam headlamps and open the hood.



4. On the wall or screen you will observe a flat zone of high intensity light located at the top of the beam pattern. If the top edge of the flat zone of high intensity light is not on the horizontal reference line, adjust the aim of the headlamp beam.

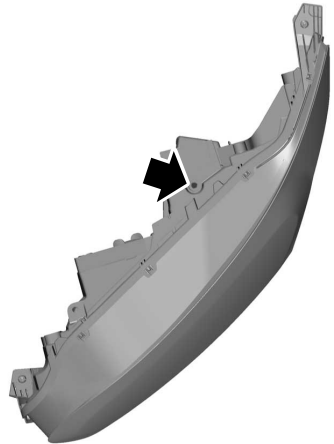

E164485

5. Locate the vertical adjuster on each headlamp. Use a suitable tool, for example a screwdriver or hexagonal socket, to turn the adjuster clockwise or counterclockwise to adjust the vertical aim of the headlamp. The horizontal edge of the brighter light should touch the horizontal reference line.
6. Close the hood and switch off the lamps.

Horizontal Aim Adjustment

The horizontal aim of the headlamp beam on your vehicle is not adjustable.

Maintenance

EXTERIOR BULBS

EXTERIOR BULB SPECIFICATION CHART

Replacement bulbs are specified in the chart below. Headlamp bulbs must be

marked with an authorized D.O.T. marking for North America to make sure they have the proper lamp performance, light brightness, light pattern and safe visibility. The correct bulbs will not damage the lamp assembly or void the lamp assembly warranty and will provide quality bulb illumination time.

Lamp	Specification	Power (Watt)
Headlamp low beam and headlamp high beam. ¹	D5S	25
Daytime running lamps. ¹	LED.	-
Headlamp low beam and daytime running lamp. ²	H11	55
Headlamp high beam. ²	9005	60
Cornering lamps.	H11	55
Front fog lamp.	H8	35
Front parking lamp.	3457NAK	21
Front turn signal lamp. ¹	PY24W	24
Front turn signal lamp. ²	3457NAK	21
Front side marker lamp. ³	W5W	5
Clearance lamp.	W5WL	5
Body side marker lamp.	W5W	5
Mirror turn signal lamp. ⁴	W16W	16
Mirror turn signal lamp. ⁵	WY5W	5
Rear lamp and stoplamp.	P21/5W	21/5
Reversing lamp.	P21W	21
Rear turn signal lamp.	PY21W	21
Rear fog lamp.	P21W	21

Maintenance

Lamp	Specification	Power (Watt)
High mounted stoplamp.	LED.	-
License plate lamp.	W5W	5
Chassis cab rear marker lamp.	W5W	5
Roof outline marker lamp.	W5W	5
Front grille marker lamp. ⁶	LED.	-

¹ Vehicles with High Intensity Discharge Headlamps.

² Vehicles with Halogen Headlamps.

³ Front side marker lamps are also available as LED lamps.

⁴ High Watt.

⁵ Low Watt.

⁶ Vehicles with Trail Package.

Note: LED lamps are not serviceable. See an authorized dealer if they fail.

Note: If the roof outline marker lamps fail have your vehicle checked.

Maintenance

REMOVING A HEADLAMP ASSEMBLY

WARNING: Switch the lamps and the ignition off. Failure to follow this warning could result in serious personal injury.

1. Open the hood. See **Opening and Closing the Hood** (page 365).

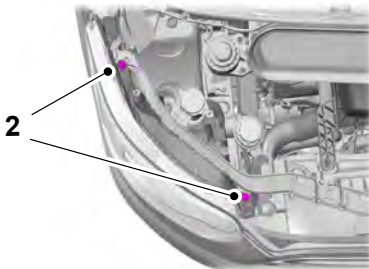

E169198

2. Remove the screws.

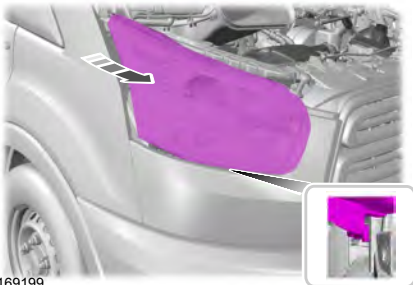

E169199

3. Pull the headlamp toward the front of your vehicle to disengage it from its locking points and then lift the headlamp up.

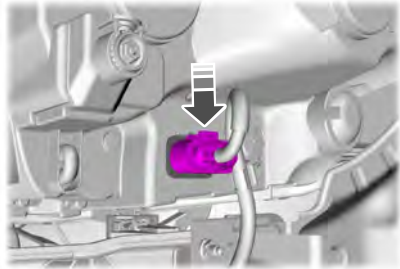

E169200

4. Disconnect the electrical connector.
5. To install, reverse the removal procedure.

Note: When you install the headlamp, make sure that you correctly attach the electrical connector.

Note: When you install the headlamp, make sure that you correctly engage its locking points.

REMOVING A REAR LAMP ASSEMBLY

WARNING: Switch the lamps and the ignition off. Failure to follow this warning could result in serious personal injury.

Maintenance

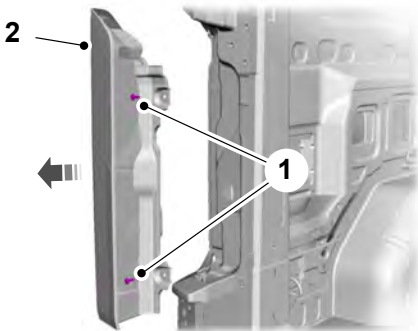

E175758

1. Remove the screws.
2. Remove the lamp.
3. To install, reverse the removal procedure.

CHANGING A HEADLAMP BULB

WARNING: Switch the lamps and the ignition off. Failure to follow this warning could result in serious personal injury.

WARNING: Make sure the bulbs have cooled down before removing them. Failure to follow this warning could result in serious personal injury.

Use the correct specification bulb. See **Exterior Bulb Specification Chart** (page 388).

You must remove the headlamp assembly prior to replacing any bulb. See **Removing a Headlamp Assembly** (page 390).

Note: LED lamps are not serviceable. See an authorized dealer if they fail.

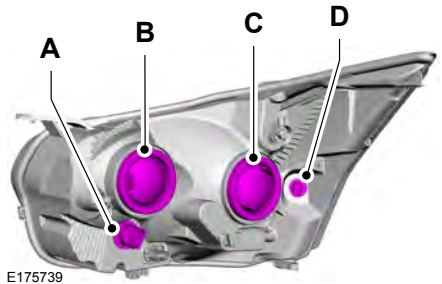

E175739

- A Front parking lamp and front turn signal lamp.
- B Headlamp high beam.
- C Headlamp low beam and daytime running lamp.
- D Front side marker lamp.

Replacing the Headlamp High Beam Bulbs

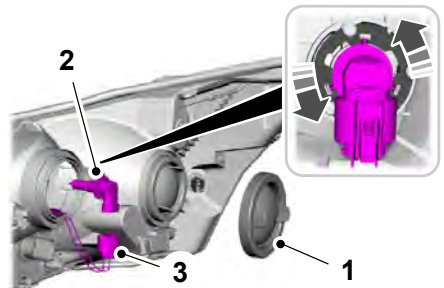

1. Carefully remove the cover.
2. Turn the bulb counterclockwise and remove it.
3. Disconnect the electrical connector.
4. To install, reverse the removal procedure.

Note: Do not touch the bulb glass.

Maintenance

Note: You cannot separate the bulb from the bulb holder.

Replacing the Headlamp Low Beam and Daytime Running Lamp Bulbs

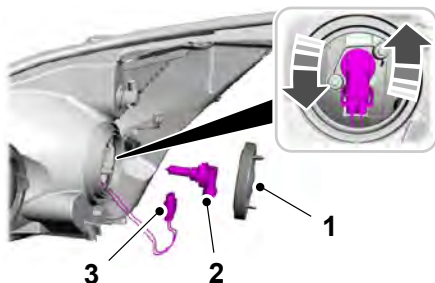

1. Carefully remove the cover.
2. Turn the bulb counterclockwise and remove it.
3. Disconnect the electrical connector.
4. To install, reverse the removal procedure.

Note: Do not touch the bulb glass.

Note: You cannot separate the bulb from the bulb holder.

Replacing the High Intensity Discharge Headlamp Bulbs

These lamps operate at a high voltage. See an authorized dealer if they fail.

CHANGING A FRONT PARKING LAMP BULB



WARNING: Switch the lamps and the ignition off. Failure to follow this warning could result in serious personal injury.



WARNING: Make sure the bulbs have cooled down before removing them. Failure to follow this warning could result in serious personal injury.

Use the correct specification bulb. See **Exterior Bulb Specification Chart** (page 388).

You must remove the headlamp assembly prior to replacing any bulb. See **Removing a Headlamp Assembly** (page 390).

Note: LED lamps are not serviceable. See an authorized dealer if they fail.

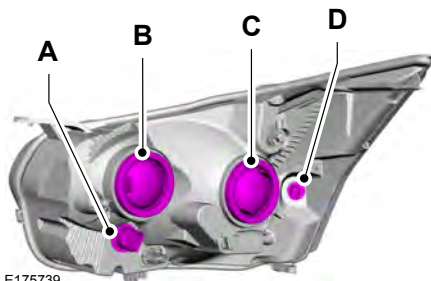

- A Front parking lamp and front turn signal lamp.
- B Headlamp high beam.
- C Headlamp low beam and daytime running lamp.
- D Front side marker lamp.

Maintenance

Replacing the Front Parking Lamp and Front Turn Signal Lamp Bulbs

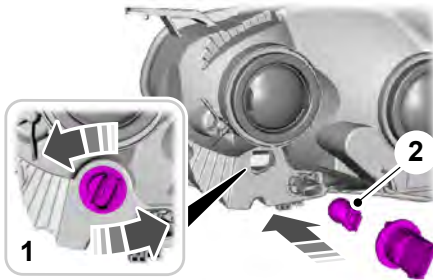

1. Turn the bulb holder counterclockwise and remove it.
2. Remove the bulb by pulling it straight out.
3. To install, reverse the removal procedure.

CHANGING A FRONT TURN SIGNAL LAMP BULB



WARNING: Switch the lamps and the ignition off. Failure to follow this warning could result in serious personal injury.



WARNING: Make sure the bulbs have cooled down before removing them. Failure to follow this warning could result in serious personal injury.

Use the correct specification bulb. See **Exterior Bulb Specification Chart** (page 388).

You must remove the headlamp assembly prior to replacing any bulb. See **Removing a Headlamp Assembly** (page 390).

Note: LED lamps are not serviceable. See an authorized dealer if they fail.

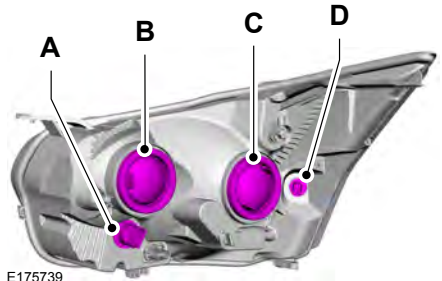

- A Front parking lamp and front turn signal lamp.
- B Headlamp high beam.
- C Headlamp low beam and daytime running lamp.
- D Front side marker lamp.

Replacing the Front Parking Lamp and Front Turn Signal Lamp Bulbs



1. Turn the bulb holder counterclockwise and remove it.
2. Remove the bulb by pulling it straight out.
3. To install, reverse the removal procedure.

Maintenance

CHANGING A FRONT SIDE MARKER LAMP BULB

WARNING: Switch the lamps and the ignition off. Failure to follow this warning could result in serious personal injury.

WARNING: Make sure the bulbs have cooled down before removing them. Failure to follow this warning could result in serious personal injury.

Use the correct specification bulb. See **Exterior Bulb Specification Chart** (page 388).

You must remove the headlamp assembly prior to replacing any bulb. See **Removing a Headlamp Assembly** (page 390).

Note: LED lamps are not serviceable. See an authorized dealer if they fail.

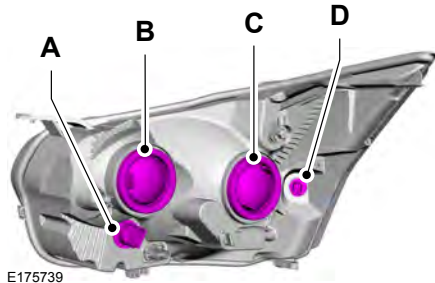

E175739

- A Front parking lamp and front turn signal lamp.
- B Headlamp high beam.
- C Headlamp low beam and daytime running lamp.
- D Front side marker lamp.

Replacing the Front Side Marker Lamp Bulbs

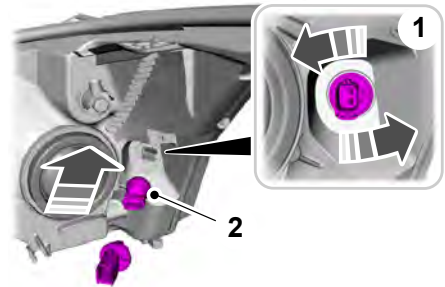

1. Turn the bulb holder counterclockwise and remove it.
2. Remove the bulb by pulling it straight out.
3. To install, reverse the removal procedure.

CHANGING A CLEARANCE LAMP BULB

WARNING: Switch the lamps and the ignition off. Failure to follow this warning could result in serious personal injury.

WARNING: Make sure the bulbs have cooled down before removing them. Failure to follow this warning could result in serious personal injury.

Use the correct specification bulb. See **Exterior Bulb Specification Chart** (page 388).

Note: LED lamps are not serviceable. See an authorized dealer if they fail.

Maintenance

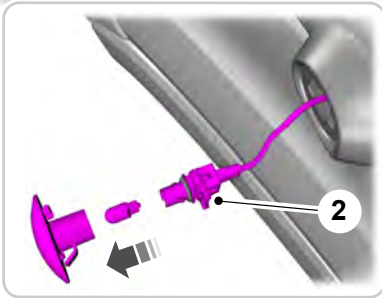
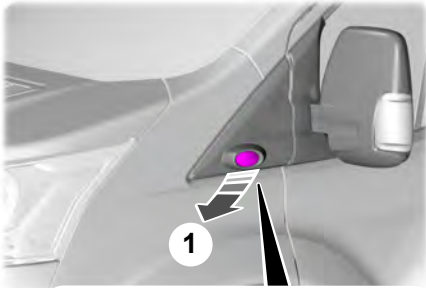

E181397

1. Use a suitable tool, for example a screwdriver, to carefully remove the lamp.
2. Turn the bulb holder counterclockwise and remove it.
3. Remove the bulb by pulling it straight out.
4. To install, reverse the removal procedure.

CHANGING A MIRROR TURN SIGNAL LAMP BULB



WARNING: Switch the lamps and the ignition off. Failure to follow this warning could result in serious personal injury.



WARNING: Make sure the bulbs have cooled down before removing them. Failure to follow this warning could result in serious personal injury.

Use the correct specification bulb. See **Exterior Bulb Specification Chart** (page 388).

Note: LED lamps are not serviceable. See an authorized dealer if they fail.

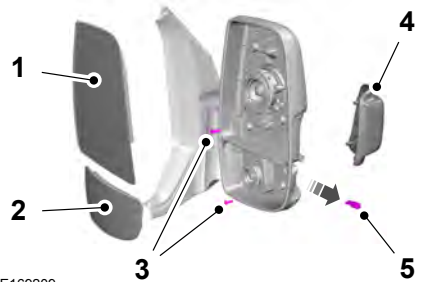

E169209

1. Remove the large mirror glass. Tilt the mirror glass fully up and pull the mirror glass toward you from the bottom.
2. Remove the small mirror glass. Tilt the mirror glass fully down and pull the mirror glass toward you from the top.
3. Remove the screws.
4. Remove the lamp lens.
5. Remove the bulb.
6. To install, reverse the removal procedure.

CHANGING A REAR LAMP BULB



WARNING: Switch the lamps and the ignition off. Failure to follow this warning could result in serious personal injury.

Maintenance

WARNING: Make sure the bulbs have cooled down before removing them. Failure to follow this warning could result in serious personal injury.

Use the correct specification bulb. See **Exterior Bulb Specification Chart** (page 388).

You must remove the rear lamp assembly prior to replacing any bulb. See **Removing a Rear Lamp Assembly** (page 390).

Note: LED lamps are not serviceable. See an authorized dealer if they fail.



1. Turn the bulb holder counterclockwise and remove it.

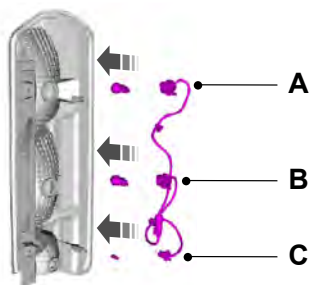

- A Tail lamp and stoplamp.
- B Reversing lamp.
- C Rear clearance lamp.

2. Remove the bulb by pulling it straight out.
3. To install, reverse the removal procedure.

CHANGING A STOPLAMP BULB

WARNING: Switch the lamps and the ignition off. Failure to follow this warning could result in serious personal injury.

WARNING: Make sure the bulbs have cooled down before removing them. Failure to follow this warning could result in serious personal injury.

Use the correct specification bulb. See **Exterior Bulb Specification Chart** (page 388).

You must remove the rear lamp assembly prior to replacing any bulb. See **Removing a Rear Lamp Assembly** (page 390).

Note: LED lamps are not serviceable. See an authorized dealer if they fail.

Maintenance



1. Turn the bulb holder counterclockwise and remove it.

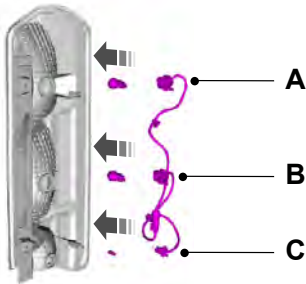

- A Tail lamp and stoplamp.
- B Reversing lamp.
- C Rear clearance lamp.

2. Remove the bulb by pulling it straight out.
3. To install, reverse the removal procedure.

CHANGING A REVERSING LAMP BULB

 **WARNING:** Switch the lamps and the ignition off. Failure to follow this warning could result in serious personal injury.

 **WARNING:** Make sure the bulbs have cooled down before removing them. Failure to follow this warning could result in serious personal injury.

Use the correct specification bulb. See **Exterior Bulb Specification Chart** (page 388).

You must remove the rear lamp assembly prior to replacing any bulb. See **Removing a Rear Lamp Assembly** (page 390).

Note: *LED lamps are not serviceable. See an authorized dealer if they fail.*



1. Turn the bulb holder counterclockwise and remove it.

Maintenance

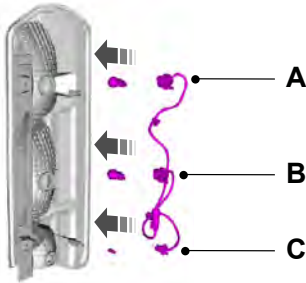

- A Tail lamp and stoplamp.
- B Reversing lamp.
- C Rear clearance lamp.

2. Remove the bulb by pulling it straight out.
3. To install, reverse the removal procedure.

CHANGING A LICENSE PLATE LAMP BULB

WARNING: Switch the lamps and the ignition off. Failure to follow this warning could result in serious personal injury.

WARNING: Make sure the bulbs have cooled down before removing them. Failure to follow this warning could result in serious personal injury.

Use the correct specification bulb. See **Exterior Bulb Specification Chart** (page 388).

Note: LED lamps are not serviceable. See an authorized dealer if they fail.

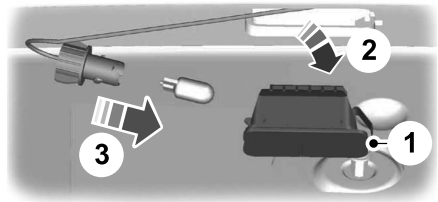

1. Carefully release the spring clip.
2. Remove the lamp.
3. Turn the bulb holder counterclockwise and remove it. Remove the bulb by pulling it straight out.
4. To install, reverse the removal procedure.

Maintenance

INTERIOR BULBS

INTERIOR BULB SPECIFICATION CHART

Lamp	Specification	Power (Watt)
Front interior lamp.	W6W	6
Front interior lamp. ¹	Festoon	6
Luggage compartment lamp.	211 Festoon	10
Map reading lamp.	W6W	6
Side door entrance lamp.	211 Festoon	10

¹ Vehicles with anti-theft alarm.

Note: LED lamps are not serviceable. See an authorized dealer if they fail.

Maintenance

CHANGING A FRONT INTERIOR LAMP BULB

WARNING: Switch the lamps and the ignition off. Failure to follow this warning could result in serious personal injury.

WARNING: Make sure the bulbs have cooled down before removing them. Failure to follow this warning could result in serious personal injury.

Use the correct specification bulb. See **Interior Bulb Specification Chart** (page 399).

Note: LED lamps are not serviceable. See an authorized dealer if they fail.

Vehicles With Interior Sensors

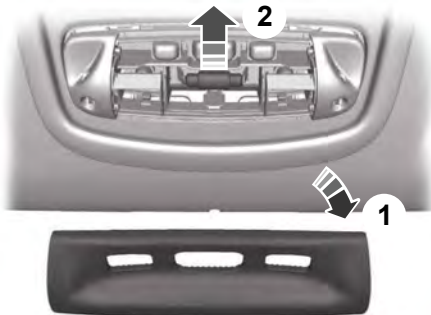

E154370

1. Carefully remove the lens.
2. Remove the bulb.
3. To install, reverse the removal procedure.

CHANGING A MAP READING LAMP BULB

WARNING: Switch the lamps and the ignition off. Failure to follow this warning could result in serious personal injury.

WARNING: Make sure the bulbs have cooled down before removing them. Failure to follow this warning could result in serious personal injury.

Use the correct specification bulb. See **Interior Bulb Specification Chart** (page 399).

Note: LED lamps are not serviceable. See an authorized dealer if they fail.

Vehicles With Interior Sensors

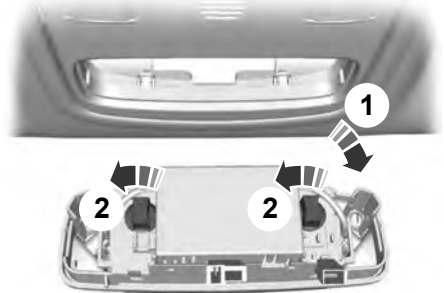

E72786

1. Use a suitable tool, for example a screwdriver, to carefully remove the lamp.
2. Turn the bulb holder counterclockwise and remove it.

Maintenance

CHANGING A VANITY MIRROR LAMP BULB

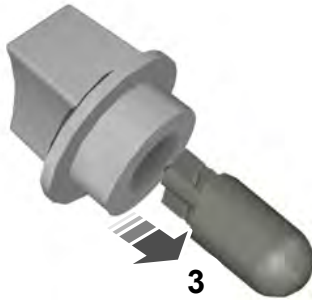

E73939

3. Remove the bulb.
4. To install, reverse the removal procedure.

Vehicles Without Interior Sensors

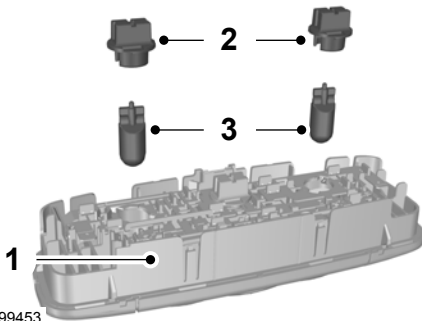

E99453

1. Use a suitable tool, for example a screwdriver, to carefully remove the lamp.
2. Turn the bulb holder counterclockwise and remove it.
3. Remove the bulb.
4. To install, reverse the removal procedure.

 **WARNING:** Switch the lamps and the ignition off. Failure to follow this warning could result in serious personal injury.

 **WARNING:** Make sure the bulbs have cooled down before removing them. Failure to follow this warning could result in serious personal injury.

Use the correct specification bulb. See **Interior Bulb Specification Chart** (page 399).

Note: *LED lamps are not serviceable. See an authorized dealer if they fail.*

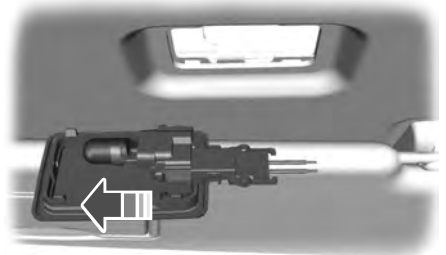

E72785

1. Use a suitable tool, for example a screwdriver, to carefully remove the lamp.
2. Remove the bulb.
3. To install, reverse the removal procedure.

FUEL FILTER - GASOLINE

Your vehicle is equipped with a lifetime fuel filter that is integrated with the fuel tank. Regular maintenance or replacement is not needed.

Maintenance

DRIVE BELT ROUTING - GASOLINE, VEHICLES WITH: DUAL GENERATORS

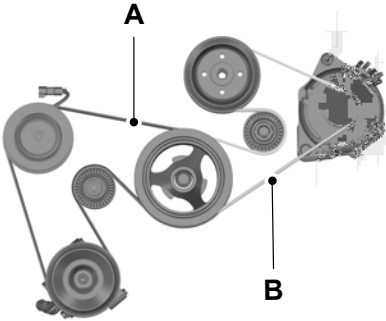

- A Drives the air conditioning compressor and a generator.
- B Drives the coolant pump and a generator.

DRIVE BELT ROUTING - GASOLINE, VEHICLES WITH: SINGLE GENERATOR

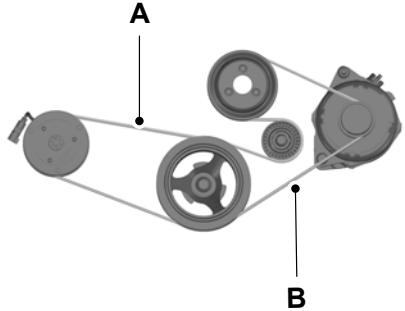

- A Drives the air conditioning compressor.
- B Drives the coolant pump and the generator.

Vehicle Care

CLEANING THE EXTERIOR

CLEANING THE EXTERIOR PRECAUTIONS

Immediately remove fuel spillages, additive residuals, bird droppings, insect deposits and road tar. These may cause damage to your vehicle's paintwork or trim over time. Remove any exterior accessories, for example antennas, before entering a car wash.

CLEANING HEADLAMPS AND REAR LAMPS

We recommend that you only use cold or lukewarm water containing car shampoo to clean the headlamps and the rear lamps.

Do not scrape the lamps.

Do not wipe lamps when they are dry.

CLEANING WINDOWS AND WIPER BLADES

To clean the windshield and wiper blades:

- Clean the windshield with a non-abrasive glass cleaner.

Note: *When cleaning the interior of the windshield, avoid getting any glass cleaner on the instrument panel or door panels. Wipe any glass cleaner off these surfaces immediately.*

- Clean the wiper blades with washer fluid or water applied with a soft sponge or cloth.

Note: *Do not use razor blades or other sharp objects to clean or remove decals from the inside of the heated rear window. This can cause damage not covered by the vehicle Warranty.*

Note: *We recommend cleaning the power sliding rear window at regular intervals to avoid dust and debris accumulation to deliver appropriate function.*

CLEANING CHROME, ALUMINIUM OR STAINLESS STEEL

We recommend that you only use a car shampoo, a soft cloth and water on bumpers and other chrome, aluminium or stainless steel parts.

Note: *For additional information and assistance, we recommend that you contact an authorized dealer.*

Note: *Rinse the area well after cleaning.*

Note: *Do not use abrasive materials, for example steel wool or plastic pads, as they can scratch these surfaces.*

Note: *Do not use chrome cleaner, metal cleaner or polish on wheels or wheel covers.*

CLEANING WHEELS

Only use a recommended wheel and tire cleaner to clean the wheels weekly. For additional information and assistance, we recommend that you contact an authorized dealer.

1. Use a sponge to remove heavy deposits of dirt and brake dust.
2. Rinse well after cleaning.

Note: *Do not apply a cleaning chemical to warm or hot wheel rims and covers.*

If you intend on parking your vehicle for an extended period after cleaning the wheels with a wheel cleaner, drive your vehicle for a few minutes before parking your vehicle. This reduces the risk of corrosion of the brake discs, brake pads and linings.

Do not clean the wheels when they are hot.

Note: *Some car washes could damage wheel rims and covers.*

Vehicle Care

Note: *Using non-recommended cleaners, harsh cleaning products, chrome wheel cleaners or abrasive materials could damage wheel rims and covers.*

CLEANING THE ENGINE COMPARTMENT - GASOLINE

Use a vacuum cleaner to remove debris from the screen area below the windshield.

Note: *If you are not familiar with the parts around the engine do not wash the engine compartment. Avoid frequent engine washes.*

When washing the engine compartment:

- Never wash or rinse the engine while it is hot or running.
- Never wash or rinse any ignition coil, spark plug wire or spark plug well.
- Cover the battery, power distribution box, and air filter assembly to prevent water damage.

Note: *If your vehicle has an engine cover remove the cover before application of shampoo and degreaser.*

- Spray an approved engine shampoo and degreaser on all parts that require cleaning and rinse with water.

Note: *Follow the manufacturer's instructions for using engine shampoo and degreaser.*

CLEANING STRIPES OR GRAPHICS

It is recommended to wash your vehicle by hand however, pressure washing may be used under the following conditions:

- Use a spray with a minimum of 40° wide spray angle pattern.
- Keep the nozzle 12 in (30 cm) and at a 90° angle to your vehicle.

- Do not use water pressure higher than 1,000 psi (6,895 kPa).
- Do not use water hotter than 73°F (23°C).

Note: *Holding the pressure washer nozzle at an angle to the vehicle's surface may damage graphics and cause the edges to peel away.*

CLEANING CAMERA LENSES AND SENSORS

We recommend that you only use lukewarm or cold water and a soft cloth to clean the camera lens and sensors.

Note: *Do not pressure wash camera lens and sensors.*

CLEANING THE UNDERBODY

Flush the complete underside of your vehicle frequently. Keep body and door drain holes free from packed dirt.

Rear suspension components may require regular cleaning with a power washer or a thorough rinse with a strong stream of water if the vehicle is operated in dusty or muddy environments. Rear leaf springs or other suspension components may emit squeaking or popping noises while operating the vehicle if particles, such as dirt, rocks, or other debris, are present in the components.

Vehicle Care

CLEANING THE INTERIOR

CLEANING THE INSTRUMENT PANEL



WARNING: Do not use chemical solvents or strong detergents when cleaning the steering wheel or instrument panel to avoid contamination of the airbag system.

We recommend that you only clean the instrument panel and cluster lens with a damp soft cloth. Dry the area with a clean, soft cloth.

For additional information and assistance, we recommend that you contact an authorized dealer.

Note: *Avoid cleaners or polishes that increase the gloss of the upper portion of the instrument panel. The dull finish in this area helps protect you from undesirable windshield reflection.*

CLEANING PLASTIC

We recommend that you only use a mild soap and water solution on a soft cloth. Dry the area with a clean, soft cloth.

CLEANING DISPLAYS AND SCREENS

We recommend that you only use a microfiber cloth in a circular motion to clean off the fingerprint or dust.

If dirt or fingerprints are still on the screen, apply a small amount of alcohol to the cloth and try to clean it again.

Note: *Do not pour or spray alcohol onto the touchscreen.*

Note: *Do not use detergent or any type of solvent to clean the touchscreen.*

CLEANING FABRIC



WARNING: On vehicles equipped with seat-mounted airbags, do not use chemical solvents or strong detergents. Such products could contaminate the side airbag system and affect performance of the side airbag in a crash.

We recommend that you only clean fabric in the following way:

1. Remove dust and loose dirt with a vacuum cleaner.
2. Wipe the surface with a soft, damp cloth and a mild soap and water solution. Dry the area with a clean, soft cloth.
3. For additional information and assistance, we recommend that you contact an authorized dealer.

For heavy stains, spot clean the area. If a ring forms on the fabric, clean the entire area immediately, but do not oversaturate or the ring could set.

CLEANING LEATHER



WARNING: On vehicles equipped with seat-mounted airbags, do not use chemical solvents or strong detergents. Such products could contaminate the side airbag system and affect performance of the side airbag in a crash.

We recommend that you only clean the leather surfaces in the following way:

1. Remove dust and loose dirt with a vacuum cleaner.
2. Wipe the surface with a soft, damp cloth and a mild soap and water solution. Dry the area with a clean, soft cloth.

Vehicle Care

3. Make sure the leather is dry, then apply a small amount of conditioner to a clean, dry cloth.
 4. Rub the conditioner into the leather until it disappears. Allow the conditioner to dry, then repeat the process for the entire interior. If a film appears, wipe it off with a dry, clean cloth.
 5. For additional information and assistance, we recommend that you contact an authorized dealer.
2. Wipe the surface with a soft, damp cloth and a mild soap and water solution. Dry the area with a clean, soft cloth.
 3. For additional information and assistance, we recommend that you contact an authorized dealer.

For heavy stains, spot clean the area. If a ring forms on the fabric, clean the entire area immediately, but do not oversaturate or the ring could set.

We recommend that you only clean your floor mats in the following way:

1. Remove dust and loose dirt with a vacuum cleaner.
2. Wash rubber floor mats using mild soap and lukewarm or cold water.
3. Completely dry the floor mat before placing them back in your vehicle.

CLEANING VINYL



WARNING: On vehicles equipped with seat-mounted airbags, do not use chemical solvents or strong detergents. Such products could contaminate the side airbag system and affect performance of the side airbag in a crash.

We recommend that you only clean vinyl surfaces in the following way:

1. Remove dust and loose dirt with a vacuum cleaner.
2. Wipe the surface with a soft, damp cloth and a mild soap and water solution. Dry the area with a clean, soft cloth.
3. For additional information and assistance, we recommend that you contact an authorized dealer.

CLEANING SEATBELTS



WARNING: Do not use cleaning solvents, bleach or dye on the vehicle's seatbelts, as these actions may weaken the belt webbing.

1. Wipe the surface with a soft, damp cloth and a mild soap and water solution. Dry the area with a clean, soft cloth.

CLEANING CARPETS AND FLOOR MATS

We recommend that you only clean your carpets in the following way:

1. Remove dust and loose dirt with a vacuum cleaner.

CLEANING STORAGE COMPARTMENTS

1. Remove dust and loose dirt with a vacuum cleaner.
2. Wipe the surface with a soft, damp cloth and a mild soap and water solution. Dry the area with a clean, soft cloth.

Vehicle Care

REPAIRING MINOR PAINT DAMAGE

We recommend that you contact an authorized dealer to identify your vehicle color code. Authorized dealers have touch-up paint to match your vehicle's color.

Before repairing minor paint damage, use a cleaner to remove particles such as bird droppings, tree sap, insect deposits, tar spots, road salt and industrial fallout.

Read the instructions before using cleaning products.

WAXING YOUR VEHICLE

Wax the high-gloss painted surface of your prewashed vehicle once or twice a year.

We recommend that you only use an approved quality wax that does not contain abrasives. Follow the manufacturer's instructions to apply and remove the wax. For additional information and assistance, we recommend that you contact an authorized dealer.

When washing and waxing, park your vehicle in a shaded area out of direct sunlight.

Note: *Avoid waxing unpainted or low-gloss black colored parts, they discolor over time.*

Storing Your Vehicle

PREPARING YOUR VEHICLE FOR STORAGE

If you plan on storing your vehicle for 30 days or more, the following maintenance recommendations ensure your vehicle stays in good operating condition.

Under various conditions, long-term storage could lead to degraded engine performance or failure unless you use specific precautions to preserve your vehicle.

General

- Store all vehicles in a dry, ventilated place.
- If vehicles are stored outside, they require regular maintenance to protect against rust and weather damage.
- Make sure all linkages, cables, levers and pins under your vehicle are covered with grease to prevent rust.
- Move vehicles at least 25 ft (7.5 m) every 15 days to lubricate working parts and prevent corrosion.
- Fill the fuel tank with high-quality fuel until the first automatic shutoff of the fuel pump nozzle.

Engine

- Change the engine oil and filter prior to storage because used engine oil contains contaminants which could cause engine damage.
- Start the engine every 15 days for a minimum of 15 minutes. Run at fast idle with the climate controls set to defrost until the engine reaches normal operating temperature.
- With your foot on the brake, shift through all the gears while the engine is running.

Body

- Wash your vehicle thoroughly to remove dirt, grease, oil, tar or mud from exterior surfaces, rear-wheel housings and the underside of front fenders.
- Periodically wash your vehicle if it is stored in exposed locations.
- Touch-up exposed or primed metal to prevent rust.
- Cover chrome and stainless steel parts with a thick coat of auto wax to prevent discoloration. Re-wax as necessary when you wash your vehicle.
- Lubricate all hood, door and luggage compartment hinges and latches with a light grade oil.
- Cover interior trim to prevent fading.
- Keep all rubber parts free from oil and solvents.

Hybrid Battery Systems

We recommend the following actions for your vehicle:

- When storing your vehicle for greater than 30 days the state of charge should be approximately 50%. Additionally we recommend disconnecting the 12V battery which reduces system loads on the HV battery.

12 Volt Battery

- Check and recharge as necessary. Keep connections clean.

Note: *It is necessary to reset memory features if you disconnect the battery cables.*

Tires

- Maintain recommended air pressure.

Storing Your Vehicle

Brakes

Make sure the brakes and parking brake release fully.

Note: *If you intend on parking your vehicle for an extended period after washing your vehicle or cleaning the wheels, drive your vehicle for a few minutes before doing so to reduce the risk of increased corrosion of the brake discs, brake pads and linings.*

Contact an authorized dealer if you have any concerns or issues.

REMOVING YOUR VEHICLE FROM STORAGE

When your vehicle is ready to come out of storage, do the following:

- We recommend that you change the engine oil before you use your vehicle again.
- Wash your vehicle to remove any dirt or grease film build-up on window surfaces.
- Check windshield wipers for any deterioration.
- Check the underhood for any foreign materials such as mice or squirrel nests.
- Check the exhaust for any foreign materials.
- Check tire pressures and set tire inflation per the Tire Label.
- Check brake pedal operation. Corroded brake rotors could cause brake noise. Drive your vehicle and gently apply and release the brakes repeatedly over a 10-minute drive to reduce the corrosion from the brakes.
- Check fluid levels (including coolant, oil and gas) to make sure there are no leaks, and fluids are at recommended levels.
- If you remove the battery, clean the battery cable ends and check for damage.

Wheel and Tire Information

LOCATING THE TIRE LABEL

The tire label or safety certification label is on the driver side B-pillar or the edge of the driver door. It contains information on the recommended front and rear tire inflation pressures. See **Locating the Safety Compliance Certification Labels** (page 311).

DEPARTMENT OF TRANSPORTATION UNIFORM TIRE QUALITY GRADES



Tire Quality Grades apply to new pneumatic passenger car tires. The Quality grades can be found where applicable on the tire sidewall between tread shoulder and maximum section width. For example: **Treadwear 200 Traction AA Temperature A.**

These Tire Quality Grades are determined by standards that the United States Department of Transportation has set.

Tire Quality Grades apply to new pneumatic passenger car tires. They do not apply to deep tread, winter-type snow tires, space-saver or temporary use spare tires, light truck or LT type tires, tires with nominal rim diameters of 10 to 12 inches or limited production tires as defined in Title 49 Code of Federal Regulations Part 575.104 (c)(2).

U.S. Department of Transportation Tire quality grades: The U.S. Department of Transportation requires us to give you the following information about tire grades exactly as the government has written it.

Treadwear

The treadwear grade is a comparative rating based on the wear rate of the tire when tested under controlled conditions on a specified government test course. For example, a tire graded 150 would wear 1½ times as well on the government course as a tire graded 100. The relative performance of tires depends upon the actual conditions of their use, however, and may depart significantly from the norm due to variations in driving habits, service practices, and differences in road characteristics and climate.

Wheel and Tire Information

Traction AA A B C



WARNING: The traction grade assigned to this tire is based on straight-ahead braking traction tests, and does not include acceleration, cornering, hydroplaning or peak traction characteristics.

The traction grades, from highest to lowest are AA, A, B, and C. The grades represent the tire's ability to stop on wet pavement as measured under controlled conditions on specified government test surfaces of asphalt and concrete. A tire marked C may have poor traction performance.

Temperature A B C



WARNING: The temperature grade for this tire is established for a tire that is properly inflated and not overloaded. Excessive speed, underinflation, or excessive loading, either separately or in combination, can cause heat buildup and possible tire failure.

The temperature grades are A (the highest), B and C, representing the tire's resistance to the generation of heat and its ability to dissipate heat when tested under controlled conditions on a specified indoor laboratory

test wheel. Sustained high temperature can cause the material of the tire to degenerate and reduce tire life, and excessive temperature can lead to sudden tire failure. The grade C corresponds to a level of performance which all passenger car tires must meet under the Federal Motor Vehicle Safety Standard No. 139. Grades B and A represent higher levels of performance on the laboratory test wheel than the minimum required by law.

INFORMATION ON THE TIRE SIDEWALL

Both United States and Canada Federal regulations require tire manufacturers to place standardized information on the sidewall of all tires. This information identifies and describes the fundamental characteristics of the tire and also provides a U.S. DOT Tire Identification Number for safety standard certification and in case of a recall.

Wheel and Tire Information

Information on P Type Tires

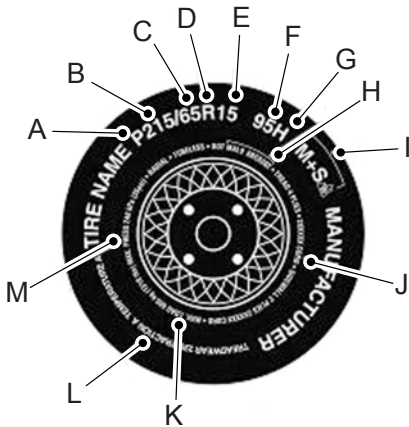

P215/65R15 95H is an example of a tire size, load index and speed rating. The definitions of these items are listed below. (Note that the tire size, load index and speed rating for your vehicle may be different from this example.)

A. **P:** Indicates a tire, designated by the Tire and Rim Association, that may be used for service on cars, sport utility vehicles, minivans and light trucks. **Note:** If your tire size does not begin with a letter this may mean it is designated by either the European Tire and Rim Technical Organization or the Japan Tire Manufacturing Association.

B. **215:** Indicates the nominal width of the tire in millimeters from sidewall edge to sidewall edge. In general, the larger the number, the wider the tire.

C. **65:** Indicates the aspect ratio which gives the tire's ratio of height to width.

D. **R:** Indicates a radial type tire.

E. **15:** Indicates the wheel or rim diameter in inches. If you change your wheel size, you will have to purchase new tires to match the new wheel diameter.

F. **95:** Indicates the tire's load index. It is an index that relates to how much weight a tire can carry. You may find this information in your owner's manual. If not, contact a local tire dealer.

Note: You may not find this information on all tires because it is not required by federal law.

G. **H:** Indicates the tire's speed rating. The speed rating denotes the speed at which a tire is designed to be driven for extended periods of time under a standard condition of load and inflation pressure. The tires on your vehicle may operate at different conditions for load and inflation pressure. These speed ratings may need to be adjusted for the difference in conditions. The ratings range from 81 mph (130 km/h) to 186 mph (299 km/h). These ratings are listed in the following chart.

Wheel and Tire Information

Note: You may not find this information on all tires because it is not required by federal law.

Letter rating	Speed rating
M	81 mph (130 km/h)
N	87 mph (140 km/h)
Q	99 mph (159 km/h)
R	106 mph (171 km/h)
S	112 mph (180 km/h)
T	118 mph (190 km/h)
U	124 mph (200 km/h)
H	130 mph (210 km/h)
V	149 mph (240 km/h)
W	168 mph (270 km/h)
Y	186 mph (299 km/h)

Note: For tires with a maximum speed capability over 149 mph (240 km/h), tire manufacturers sometimes use the letters ZR. For those with a maximum speed capability over 186 mph (299 km/h), tire manufacturers always use the letters ZR.

H. U.S. DOT Tire Identification Number (TIN): This begins with the letters DOT and indicates that the tire meets all federal standards. The next two numbers or letters are the plant code designating where it was manufactured, the next two are

the tire size code and the last four numbers represent the week and year the tire was built. For example, the numbers 317 mean the 31st week of 1997. After 2000, the numbers go to four digits. For example, 2501 means the 25th week of 2001. The numbers in between are identification codes used for traceability. This information is used to contact customers if a tire defect requires a recall.

I. M+S or M/S: Mud and Snow, or

AT: All Terrain, or

AS: All Season.

J. Tire Ply Composition and Material Used: Indicates the number of plies or the number of layers of rubber-coated fabric in the tire tread and sidewall. Tire manufacturers also must indicate the ply materials in the tire and the sidewall, which include steel, nylon, polyester, and others.

K. Maximum Load: Indicates the maximum load in kilograms and pounds that can be carried by the tire. See the Safety Compliance Certification Label (affixed to either the door hinge pillar, door-latch post, or the door edge that meets the door-latch post, next to the driver's seating position), for the correct tire pressure for your vehicle.

L. Treadwear, Traction and Temperature Grades:

Wheel and Tire Information

***Treadwear:** The treadwear grade is a comparative rating based on the wear rate of the tire when tested under controlled conditions on a specified government test course. For example, a tire graded 150 would wear one and one-half times as well on the government course as a tire graded 100.

***Traction:** The traction grades, from highest to lowest are AA, A, B, and C. The grades represent the tire's ability to stop on wet pavement as measured under controlled conditions on specified government test surfaces of asphalt and concrete. A tire marked C may have poor traction performance.

***Temperature:** The temperature grades are A (the highest), B and C, representing the tire's resistance to the generation of heat and its ability to dissipate heat when tested under controlled conditions on a specified indoor laboratory test wheel.

M. Maximum Inflation

Pressure: Indicates the tire manufacturers' maximum permissible pressure or the pressure at which the maximum load can be carried by the tire. This pressure is normally higher than the vehicle manufacturer's recommended cold inflation pressure which can be found on the Safety Compliance Certification Label (affixed to either the door hinge pillar,

door-latch post, or the door edge that meets the door-latch post, next to the driver's seating position), or Tire Label which is located on the B-Pillar or the edge of the driver's door. The cold inflation pressure should never be set lower than the recommended pressure on the vehicle label.

The tire suppliers may have additional markings, notes or warnings such as standard load or radial tubeless.

Additional Information Contained on the Tire Sidewall for LT Type Tires

Note: *Tire Quality Grades do not apply to this type of tire.*

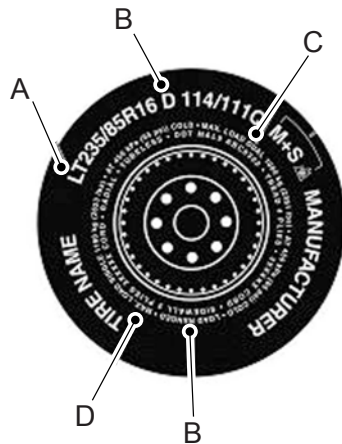

Wheel and Tire Information

LT type tires have some additional information beyond those of P type tires; these differences are described below.

A. **LT:** Indicates a tire, designated by the Tire and Rim Association, that is intended for service on light trucks.

B. **Load Range and Load Inflation Limits:** Indicates the tire's load-carrying capabilities and its inflation limits.

C. **Maximum Load Dual lb (kg) at psi (kPa) cold:** Indicates the maximum load and tire pressure when the tire is used as a dual, defined as four tires on the rear axle (a total of six or more tires on the vehicle).

D. **Maximum Load Single lb (kg) at psi (kPa) cold:** Indicates the maximum load and tire pressure when the tire is used as a single, defined as two tires (total) on the rear axle.

Information on T Type Tires

T145/80D16 is an example of a tire size.

Note: *The temporary tire size for your vehicle may be different from this example. Tire Quality Grades do not apply to this type of tire.*



T type tires have some additional information beyond those of P type tires; these differences are described below:

A. **T:** Indicates a type of tire, designated by the Tire and Rim Association, that is intended for temporary service on cars, sport utility vehicles, minivans and light trucks.

B. **145:** Indicates the nominal width of the tire in millimeters from sidewall edge to sidewall edge. In general, the larger the number, the wider the tire.

Wheel and Tire Information

C. **80:** Indicates the aspect ratio which gives the tire's ratio of height to width. Numbers of 70 or lower indicate a short sidewall.

D. **D:** Indicates a diagonal type tire.

R: Indicates a radial type tire.

E. **16:** Indicates the wheel or rim diameter in inches. If you change your wheel size, you will have to purchase new tires to match the new wheel diameter.

GLOSSARY OF TIRE TERMINOLOGY

***Tire label:** A label showing the original equipment tire sizes, recommended inflation pressure and the maximum weight the vehicle can carry.

***Tire Identification Number (TIN):** A number on the sidewall of each tire providing information about the tire brand and manufacturing plant, tire size and date of manufacture. Also referred to as DOT code.

***Inflation pressure:** A measure of the amount of air in a tire.

***Standard load:** A class of P-metric or Metric tires designed to carry a maximum load at set pressure. For example: For P-metric tires 35 psi (2.4 bar) and for Metric tires 36 psi (2.5 bar). Increasing the inflation pressure beyond this pressure will not increase the tire's load carrying capability.

***Extra load:** A class of P-metric or Metric tires designed to carry a heavier maximum load at 42 psi (2.9 bar). Increasing the inflation pressure beyond this pressure will not increase the tire's load carrying capability.

***kPa:** Kilopascal, a metric unit of air pressure.

***PSI:** Pounds per square inch, a standard unit of air pressure.

***Cold tire pressure:** The tire pressure when the vehicle has been stationary and out of direct sunlight for an hour or more and prior to the vehicle being driven for 1 mi (1.6 km).

***Recommended inflation pressure:** The cold inflation pressure found on the Safety Compliance Certification Label (affixed to either the door hinge pillar, door-latch post, or the door edge that meets the door-latch post, next to the driver's seating position), or Tire Label located on the B-Pillar or the edge of the driver door.

***B-pillar:** The structural member at the side of the vehicle behind the front door.

***Bead area of the tire:** Area of the tire next to the rim.

***Sidewall of the tire:** Area between the bead area and the tread.

Wheel and Tire Information

***Tread area of the tire:** Area of the perimeter of the tire that contacts the road when mounted on the vehicle.

***Rim:** The metal support (wheel) for a tire or a tire and tube assembly upon which the tire beads are seated.

TIRE REPLACEMENT REQUIREMENTS

AGE



WARNING: Tires degrade over time depending on many factors such as weather, storage conditions, and conditions of use (load, speed, inflation pressure) the tires experience throughout their lives.

In general, tires should be replaced after six years regardless of tread wear. However, heat caused by hot climates or frequent high loading conditions can accelerate the aging process and may require tires to be replaced more frequently.

You should replace your spare tire when you replace the road tires or after six years due to aging even if it has not been used.

U.S. DOT Tire Identification Number

Both United States and Canada Federal regulations require tire manufacturers to place standardized information on the sidewall of all tires. This information identifies and describes the fundamental characteristics of the tire and also provides a U.S. DOT Tire Identification Number for safety standard certification and in case of a recall.

This begins with the letters DOT and indicates that the tire meets all federal standards. The next two numbers or letters are the plant code designating where it was manufactured, the next two are the tire size code and the last four numbers represent the week and year the tire was built. For example, the numbers 317 mean the 31st week of 1997. After 2000, the numbers go to four digits. For example, 2501 means the 25th week of 2001. The numbers in between are identification codes used for traceability. This information is used to contact customers if a tire defect requires a recall.

Tire Replacement Requirements

Your vehicle is equipped with tires designed to provide a safe ride and handling capability.

Wheel and Tire Information



WARNING: Only use replacement tires and wheels that are the same size, load index, speed rating, and type as those originally provided for your vehicle. The recommended tire and wheel sizes can be found on the Tire Label on the driver side door frame or the edge of the driver door. If this information is not found in those locations, or for additional options, contact your authorized dealer. Use of any tire or wheel not recommended, could affect the safety and performance of your vehicle, which could result in an increased risk of loss of vehicle control, vehicle rollover, personal injury and death.



WARNING: To reduce the risk of serious injury, when mounting replacement tires and wheels, you should not exceed the maximum pressure indicated on the sidewall of the tire to set the beads without additional precautions listed below. If the beads do not seat at the maximum pressure indicated, re-lubricate and try again.



WARNING: For a mounting pressure more than 20 psi (1.38 bar) greater than the maximum pressure, a Ford dealer or other tire service professional should do the mounting.



WARNING: Always inflate steel carcass tires with a remote air fill with the person inflating standing at a minimum of 12 ft (3.66 m) away from the wheel and tire assembly.



WARNING: When inflating the tire for mounting pressures up to 20 psi (1.38 bar) greater than the maximum pressure on the tire sidewall, the following precautions must be taken to protect the person mounting the tire:

- Make sure that you have the correct tire and wheel size.
- Lubricate the tire bead and wheel bead seat area again.
- Stand at a minimum of 12 ft (3.66 m) away from the wheel and tire assembly.
- Use both eye and ear protection.

Important: Remember to replace the wheel valve stems when the road tires are replaced on your vehicle.

It is recommended that the two front tires or two rear tires generally be replaced as a pair if the worn tires still have usable depth.

Wheel and Tire Information

To avoid potential Four-Wheel Drive (4WD) malfunction or (4WD) system damage, it is recommended to replace all four tires rather than mixing significantly worn tires with new tires.

The tire pressure sensors mounted in the wheels (originally installed on your vehicle) are not designed to be used in aftermarket wheels.

The use of wheels or tires not recommended may affect the operation of your tire pressure monitoring system.

If the tire pressure monitoring system indicator is flashing, your system is malfunctioning. Your replacement tire might be incompatible with your tire pressure monitoring system, or some component of the system may be damaged.

USING WINTER TIRES





We recommend that you use winter or all-season tires carrying this symbol when the temperature is 45°F (7°C) or lower, or in snow and ice conditions.

When using winter tires, install them on all wheels and inflate them to the recommended tire pressures listed on the tire label. See **Locating the Safety Compliance Certification Labels** (page 311).

 **WARNING:** Wheels and tires must be the same size, load index and speed rating as those originally fitted on the vehicle. Use of any other tire or wheel can affect the safety and performance of your vehicle. Additionally, the use of non-recommended tires and wheels can cause steering, suspension, axle, transfer case or power transfer unit failure. Follow the recommended tire inflation pressures found on the Safety Compliance Certification label, or the Tire Label on the B-Pillar or the edge of the driver door. Failure to follow this instruction could result in loss of vehicle control, vehicle rollover, or personal injury or death.

USING SNOW CHAINS

 **WARNING:** Do not exceed 30 mph (50 km/h). Failure to follow this instruction could result in the loss of control of your vehicle, personal injury or death.

 **WARNING:** Do not use snow chains on snow-free roads.

 **WARNING:** Only fit snow chains to specified tires.

Wheel and Tire Information



WARNING: If your vehicle is fitted with wheel trims, remove them before fitting snow chains.

Your vehicle has all-weather tires designed to provide traction in all weather conditions. In some conditions you may need to use snow chains or cables.

Snow Chain Use by Tire Size

Tire Size	Variant ³		
	Rear Wheel Drive - Vehicles With Single Rear Wheels	Rear Wheel Drive - Vehicles With Dual Rear Wheels ¹	All-Wheel Drive ²
195/75R16C	N/A	Yes.	N/A
205/75R16C	N/A	Yes.	Yes.
235/65R16C	Yes.	N/A	Yes.
LT245/75R16	N/A	N/A	Yes.

¹ Only fit snow chains to the outer tires.

² Only fit snow chains to the rear tires.

³ To ascertain the variant of your vehicle, refer to the vehicle identification plate. See **Vehicle Identification Number Overview** (page 470).

Snow chains are not suitable for use with LT245/75 R16 tires. Only use snow cables of 0.3 in (8 mm) or smaller in diameter.

For other tire sizes use only use SAE Class S snow chains or cables of 0.4 in (10 mm) or smaller in diameter.

Note: Maintain correct tire pressures.

Note: The anti-lock brake system continues to correctly operate.

Note: We recommend that you switch the traction control system off. See **Switching Traction Control On and Off** (page 241). See **Switching Traction Control On and Off** (page 241).

Do not use self-tensioning snow chains.

Avoid fully loading your vehicle.

We recommend that steel wheels of the correct size and specification are used. Snow chains or cables could damage alloy wheels.

Tire Care

CHECKING THE TIRE PRESSURES

Safe operation of your vehicle requires that your tires are properly inflated. Every day before you drive, check your tires.

At least once a month and before long trips, inspect each tire and check the tire pressure with a tire gauge. Inflate all tires to the recommended inflation pressure. See **Inflating the Tires** (page 421).

INFLATING THE TIRES



WARNING: Under-inflation is the most common cause of tire failures and may result in severe tire cracking, tread separation or blowout, with unexpected loss of vehicle control and increased risk of injury. Under-inflation increases sidewall flexing and rolling resistance, resulting in heat buildup and internal damage to the tire. It also may result in unnecessary tire stress, irregular wear, loss of vehicle control and accidents. A tire can lose up to half of its air pressure and not appear to be flat!



WARNING: Do not use the tire pressure displayed in the information display as a tire pressure gauge. Failure to follow this instruction could result in personal injury or death.

Use the recommended cold inflation pressure for optimum tire performance and wear. Under-inflation or over-inflation may cause uneven treadwear patterns.

Inflate your tires to the recommended inflation pressure even if it is less than the maximum inflation pressure information found on the tire. You can find the tire label with the recommended tire inflation pressure next to the tire size on the B-Pillar or the edge of the driver door.

The recommended tire inflation pressure is also found on the Safety Compliance Certification Label, affixed to either the door hinge pillar, door-latch post, or the door edge that meets the door-latch on the B-pillar, or on the edge of the driver door.

Failure to follow the tire pressure recommendations can cause uneven treadwear patterns and adversely affect the way your vehicle handles.

Tire Care

Checking Pressure when tires are hot:

If pressures are checked after tires have been driven for more than three minutes or more than 1 mile, (2 km) the tires become hot and the pressures will increase by approximately 4 psi (27.6 kPa). Therefore when the tire pressure is adjusted under these conditions, it should be increased to a gauge reading of 4 psi (27.6 kPa) greater than the recommended cold inflation pressure.

After inflating the tires while hot, make sure to recheck tire pressure later once the tires are cold.

For Example Only

Gauge reading of hot tire	33 psi (230 kPa)
If recommended, cold inflation pressure is	32 psi (220 kPa)
The hot tire pressure is only 1 psi (10 kPa) greater than the recommended cold inflation pressure. Therefore, add 3 psi (20 kPa) more to increase the hot pressure to 4 psi (30 kPa) over the recommended cold inflation pressure.	

New hot pressure	36 psi (250 kPa)
------------------	------------------

INSPECTING THE TIRE FOR WEAR

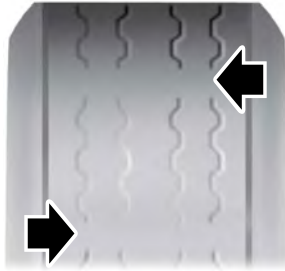

When the tread is worn down to 2/32 inch (1.6 mm), tires must be replaced to help prevent your vehicle from skidding and hydroplaning. Built-in treadwear indicators, or wear bars, which look like narrow strips of smooth rubber across the tread will appear on the tire when the tread is worn down to 2/32 inch (1.6 mm).

When the tire tread wears down to the same height as these wear bars, the tire is worn out and must be replaced.

The tires should also be balanced periodically. An unbalanced tire and wheel assembly may result in irregular tire wear.

Tire Care

Periodically inspect the tire treads for uneven or excessive wear and remove objects such as stones, nails or glass that may be wedged in the tread grooves.

INSPECTING THE TIRE FOR DAMAGE

Inspect the tire sidewalls for cracking, cuts, bruises and other signs of damage or excessive wear. If internal damage to the tire is suspected, have the tire dismantled and inspected in case it needs to be repaired or replaced. For your safety, tires that are damaged or show signs of excessive wear should not be used because they are more likely to blow out or fail.

Periodically inspect the tire treads and sidewalls for damage, such as bulges in the tread or sidewalls, cracks in the tread groove and separation in the tread or sidewall. If damage is observed or suspected, have the tire inspected by a tire professional.

Safety Practices



WARNING: If your vehicle is stuck in snow, mud or sand, do not rapidly spin the tires; spinning the tires can tear the tire and cause an explosion. A tire can explode in as little as three to five seconds.



WARNING: Do not spin the wheels at over 34 mph (55 km/h). The tires may fail and injure a passenger or bystander.

HIGH SPEED DRIVING CAN BE DANGEROUS

Correct inflation pressure is especially important. However, at high speeds, even with the correct inflation pressure, a road hazard for example is more difficult to avoid and if contact is made, has a greater chance of causing tire damage than at a lower speed. Moreover, driving at high speed reduces the reaction time available to avoid accidents and bring your vehicle to a safe stop.

If you see any damage to a tire or wheel, replace it with the spare at once and visit a participating Tire Retailer.

Exceeding the maximum speeds shown on the following page for each type of tire will cause the tire to build up excessive heat which can cause tire damage that could result in sudden tire destruction and rapid air loss. Failure to control a vehicle when one or more tires experience a sudden air loss can lead to an accident.

In any case, you should not exceed reasonable speeds as indicated by the legal limits and driving conditions.

Tire Care

DO NOT OVERLOAD: DRIVING ON ANY OVERLOADED TIRE IS DANGEROUS

The maximum load rating of your tires is molded on the tire sidewall. Do not exceed this rating. Follow the loading instructions of the manufacturer of your vehicle and this will ensure that your tires are not overloaded. Tires which are loaded beyond their maximum allowable loads for the particular application will build up excessive heat that may result in sudden tire destruction. Do not exceed the gross axle weight rating for any axle on your vehicle.

TIRE ALTERATIONS

Do not make or allow to be made any alterations on your tires. Alterations may prevent proper performance, leading to tire damage which can result in an accident. Tires which become unserviceable due to alterations such as truing, whitewall inlays, addition of balancing or sealant liquids, or the use of tire dressing containing petroleum distillates are excluded from warranty coverage.

REPAIRS - WHEREVER POSSIBLE, SEE YOUR TIRE RETAILER AT ONCE

If any tire sustains a puncture, have the tire demounted and thoroughly inspected by a tire retailer for possible damage that may have occurred. A tread area puncture in any passenger or light truck tire can be repaired provided that the puncture hole is not more than 1/4" in diameter, not more than one radial cable per casing ply is damaged, and the tire has not been damaged further by the puncturing object or by running underinflated. Tire punctures consistent with these guidelines should only be repaired by following the US Tire Manufacturers Association (USTMA) recommended repair procedures. Plug-only repairs done on-the-wheel are considered improper and therefore, not recommended. Such repairs are not reliable and may cause further damage to the tire.

STORAGE

Tires contain waxes and emollients to protect their outer surfaces from ozone and weather checking. As the tire rolls and flexes, the waxes and emollients continually migrate to the surface, replenishing this protection throughout the normal use of the tire. Consequently, when tires sit unused for long periods of time (a month or more) their surfaces

Tire Care

become dry and more susceptible to ozone and weather checking and the casing becomes susceptible to flat spotting. **For this reason, tires should always be stored in a cool, dry, clean, indoor environment. If storage is for one month or more, eliminate the weight from the tires by raising the vehicle or by removing the tires from the vehicle. Failure to store tires in accordance with these instructions could result in damage to your tires or premature aging of the tires and sudden tire failure.**

When tires are stored, be sure they are placed away from sources of heat and ozone such as direct sunlight, hot pipes and electric generators. Be sure that surfaces on which tires are stored are clean and free from grease, gasoline or other substances, which could deteriorate the rubber. Failure to store tires in accordance with these instructions could result in damage to your tires or premature aging of the tires and sudden tire failure.

FOLLOW THESE MOUNTING RECOMMENDATIONS

Tire changing can be dangerous and must be done by professionally trained persons using proper tools and procedures as specified by the US Tire Manufacturers Association (USTMA). Single or dual assemblies must be completely deflated before demounting.

Your tires should be mounted on wheels of correct size and type and which are in good, clean condition. Wheels that are bent, chipped, rusted (steel wheels) or corroded (alloy wheels) may cause tire damage. The inside of the tire must be free from foreign material. Have your retailer check the wheels before mounting new tires. Mismatched tires and rims can explode during mounting. Also, mismatched tires and rims can result in dangerous tire failure on the road. If a tire is mounted by error on the wrong-sized rim, do not remount it on the proper rim - scrap it. It may have been damaged internally (which is not externally visible) by having been dangerously stretched and could fail on the highway.

Tire Care

Old valves may leak. When new tubeless tires are mounted, have new valves of the correct type installed. Tubeless tires must only be mounted on wheels designed for tubeless tires i.e., wheels which have safety humps or ledges.

It is recommended that you have your tires and wheels balanced. Tires and wheels, which are not balanced, may cause steering difficulties, a bumpy ride, and irregular tire wear.

Be sure that all your valves have suitable valve caps. The valve cap is the primary seal against air loss.

TEMPORARY SPARE TIRES

When using any temporary spare tire, be sure to follow the vehicle manufacturer's instructions.

REMEMBER... TO AVOID DAMAGE TO YOUR TIRES AND POSSIBLE ACCIDENT:

- CHECK TIRE PRESSURE AT LEAST ONCE EACH MONTH WHEN TIRES ARE COLD AND BEFORE LONG TRIPS.
- DO NOT UNDERINFLATE/OVERINFLATE.
- DO NOT OVERLOAD.
- DRIVE AT MODERATE SPEEDS, OBSERVE LEGAL LIMITS.

- AVOID DRIVING OVER POTHOLES, OBSTACLES, CURBS OR EDGES OF PAVEMENT.
- AVOID EXCESSIVE WHEEL SPINNING.
- IF YOU SEE ANY DAMAGE TO A TIRE, REPLACE WITH THE SPARE AND VISIT ANY AUTHORIZED RETAILER AT ONCE.
- IF YOU HAVE ANY QUESTIONS, CONTACT YOUR AUTHORIZED RETAILER.

Highway Hazards

No matter how carefully you drive, there is always the possibility that you could eventually have a flat tire on the highway. Drive slowly to the closest safe area out of traffic. This could further damage the flat tire, but your safety is more important.

If you feel a sudden vibration or ride disturbance while driving, or you suspect your tire or vehicle has been damaged, immediately reduce your speed. Drive with caution until you can safely pull off the road. Stop and inspect the tires for damage. If a tire is under-inflated or damaged, deflate it, remove the wheel and replace it with your spare tire and wheel. If you cannot detect a cause, have the vehicle towed to the nearest repair facility or tire dealer to have the vehicle inspected.

Tire Care

Tire and Wheel Alignment

A bad jolt from hitting a curb or pothole can cause the front end of your vehicle to become misaligned or cause damage to your tires. If your vehicle seems to pull to one side when you are driving, the wheels could be out of alignment. Have an authorized dealer check the wheel alignment periodically.

Wheel misalignment in the front or the rear can cause uneven and rapid treadwear of your tires and should be corrected by an authorized dealer.

INSPECTING THE WHEEL VALVE STEMS

Check the valve stems for holes, cracks, or cuts that could permit air leakage.

TIRE ROTATION



WARNING: If the tire label shows different tire pressures for the front and rear tires and the vehicle has a tire pressure monitoring system, then you need to update the settings for the system sensors. Always

perform the system reset procedure after tire rotation. If you do not reset the system, it may not provide a low tire pressure warning when necessary.

Rotating your tires at the recommended interval will help your tires wear more evenly, providing better tire performance and longer tire life.

Note: *If your tires show any uneven wear have the alignment checked by an authorized dealer before rotating tires.*

Note: *If you have a dissimilar spare wheel and tire assembly, it is intended for temporary use only and should not be used in a tire rotation.*

Note: *After having your tires rotated, inflation pressure must be checked and adjusted to the vehicle requirements.*

Tire Rotation Diagram

Follow the diagram indicating the correct tire locations for rotating the tires.

Tire Care

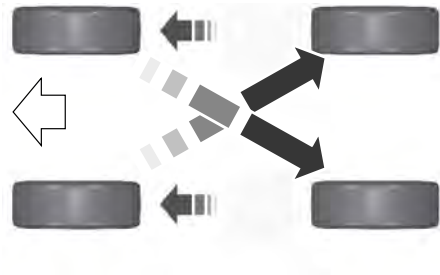

Tire Pressure Monitoring System

WHAT IS THE TIRE PRESSURE MONITORING SYSTEM



The tire pressure monitoring system measures the vehicle's tire pressures. A warning lamp illuminates if one or more tires are significantly underinflated or if there is a system malfunction.

TIRE PRESSURE MONITORING SYSTEM OVERVIEW



WARNING: Under-inflation is the most common cause of tire failures and may result in severe tire cracking, tread separation or blowout, with unexpected loss of vehicle control and increased risk of injury. Under-inflation increases sidewall flexing and rolling resistance, resulting in heat buildup and internal damage to the tire. It also may result in unnecessary tire stress, irregular wear, loss of vehicle control and accidents. A tire can lose up to half of its air pressure and not appear to be flat!



WARNING: To determine the required pressure(s) for your vehicle, see the Safety Compliance Certification Label (on the door hinge pillar, door-latch post or the door edge that meets the door-latch post, next to the driver seat) or the Tire Label on the B-Pillar or the edge of the driver door.

Each tire, including the spare (if provided), should be checked monthly when cold and inflated to the inflation pressure recommended by the vehicle manufacturer on the vehicle placard or tire inflation pressure label. (If your vehicle has tires of a different size than the size indicated on the vehicle placard or tire inflation pressure label, you should determine the proper tire inflation pressure for those tires).

As an added safety feature, your vehicle has been equipped with a Tire Pressure Monitoring System (TPMS) that illuminates a low tire pressure telltale when one or more of your tires is significantly under-inflated. Accordingly, when the low tire pressure telltale illuminates, you should stop and check your tires as soon as possible, and inflate them to the proper pressure. Driving on a significantly under-inflated tire causes the tire to overheat and can lead to tire failure. Under-inflation also reduces fuel efficiency and tire tread life, and may affect the vehicle's handling and stopping ability.

Please note that the TPMS is not a substitute for proper tire maintenance, and it is the driver's responsibility to maintain correct tire pressure, even if under-inflation has not reached the level to trigger illumination of the TPMS low tire pressure telltale.

Your vehicle has also been equipped with a TPMS malfunction indicator to indicate when the system is not operating properly. The TPMS malfunction indicator is combined with the low tire pressure telltale. When the system detects a malfunction, the telltale will flash for approximately one minute and then remain continuously illuminated. This sequence will continue upon subsequent vehicle start-ups as long as the malfunction exists.

Tire Pressure Monitoring System

When the malfunction indicator is illuminated, the system may not be able to detect or signal low tire pressure as intended. TPMS malfunctions may occur for a variety of reasons, including the installation of replacement or alternate tires or wheels on the vehicle that prevent the TPMS from functioning properly. Always check the TPMS malfunction telltale after replacing one or more tires or wheels on your vehicle to ensure that the replacement or alternate tires and wheels allow the TPMS to continue to function properly.



WARNING: Changes or modifications not expressly approved by the party responsible for compliance could void the user's authority to operate the equipment. The term "IC:" before the radio certification number only signifies that Industry Canada technical specifications were met.

This device complies with Part 15 of the FCC Rules and with License exempt RSS Standards of Industry Canada. Operation is subject to the following two conditions:

1. This device may not cause harmful interference, and
2. This device must accept any interference received, including interference that may cause undesired operation.

TIRE PRESSURE MONITORING SYSTEM PRECAUTIONS



WARNING: The tire pressure monitoring system is not a substitute for manually checking tire pressures. You should periodically check tire pressures using a pressure gauge. Failure to correctly maintain tire pressures could increase the risk of tire failure, loss of control, vehicle rollover and personal injury.



WARNING: Do not use the tire pressure displayed in the information display as a tire pressure gauge. Failure to follow this instruction could result in personal injury or death.

Note: *The use of tire sealants can damage the tire pressure monitoring system.*

Note: *If the tire pressure monitor sensor becomes damaged it may not function.*

TIRE PRESSURE MONITORING SYSTEM LIMITATIONS

When the outside temperature drops significantly, the tire pressure could decrease and activate the low tire pressure warning lamp.

The warning lamp could also illuminate when you use a spare wheel, or tire sealant from the inflator kit.

Note: *Regularly checking the vehicle tire pressures can reduce the possibility for the warning lamp to illuminate due to outside air temperature changes.*

Note: *After you inflate the tires to the recommended pressure it could take up to two minutes of driving over 20 mph (32 km/h) for the warning indicator to turn off.*

Tire Pressure Monitoring System

VIEWING THE TIRE PRESSURES



To view the current tire pressures, use the information display or touchscreen.

RESETTING TIRE PRESSURE MONITORING SYSTEM

Tire Pressure Monitoring System Reset Procedure



WARNING: To determine the required pressure(s) for your vehicle, see the Safety Compliance Certification Label (on the door hinge pillar, door-latch post or the door edge that meets the door-latch post, next to the driver seat) or the Tire Label on the B-Pillar or the edge of the driver door.

You must reset the tire pressure monitoring system after each tire rotation on vehicles that require different recommended tire pressures in the front tires as compared to the rear tires.

Note: To reduce the chances of interference from another vehicle, perform the system reset procedure at least three feet, one meter, away from another vehicle undergoing the system reset procedure at the same time.

Note: Do not wait more than two minutes between resetting each tire sensor or the system can time-out and you need to repeat the entire procedure on all four wheels.

1. Drive the vehicle above 20 mph (32 km/h) for at least two minutes, then park in a safe location where you can easily get to all four tires and have access to an air pump.
2. Switch the ignition off.
3. Switch the ignition on but do not start the engine.
4. Switch the hazard flashers on then off three times.

Note: You must accomplish this within 10 seconds. If you successfully enter the reset mode, the horn sounds once, the system indicator flashes and a message shows in the information display.

Note: If the system does not enter reset mode, try again starting at Step 2. If after repeated attempts to enter the reset mode, the horn does not sound, the system indicator does not flash and no message shows in the information display, contact your authorized dealer.

5. Remove the valve cap from the valve stem on the left front tire. Decrease the air pressure until the horn sounds.

Note: The single horn tone confirms that the sensor identification code has been learned by the module for this position. If the horn sounds twice, the reset procedure was unsuccessful, and you must repeat it.

6. Remove the valve cap from the valve stem on the right front tire. Decrease the air pressure until the horn sounds.

Tire Pressure Monitoring System

7. Repeat the previous step on the right rear tire and then on the left rear tire.
8. Switch the ignition off.

Note: *If the horn sounds twice again after switching the ignition off, and repeating the procedure, contact your authorized dealer and have your vehicle checked as soon as possible.*

9. Set all four tires to the recommended air pressure as indicated on the Safety Compliance Certification Label.

TIRE PRESSURE MONITORING SYSTEM – TROUBLESHOOTING

TIRE PRESSURE MONITORING SYSTEM – WARNING LAMPS



The low tire pressure warning lamp has combined functions, as it warns you when your tires need air, and when the system is no longer capable of functioning as intended.

Warning Lamp	Possible Cause	Action Required
Solid warning lamp	One or more tires are significantly under inflated	After inflating your tires to the manufacturer's recommended pressure as shown on the tire label, on the edge of driver door or the B-pillar, drive your vehicle for at least two minutes over 20 mph (32 km/h) before the light turns off.
	Tire rotation without sensor training	On vehicles with different front and rear tire pressures, the system must be retrained following every tire rotation.
Solid warning lamp or flashing warning lamp	Temporary spare wheel in use	Repair the damaged road wheel and tire and refit it to your vehicle to restore operation of the system.
	Tire pressure monitoring system malfunction	If the tires are inflated to the recommended tire pressures and the temporary spare wheel is not in use, the system detected a fault that requires service. Have your vehicle checked as soon as possible.

Tire Pressure Monitoring System

TIRE PRESSURE MONITORING SYSTEM – INFORMATION MESSAGES

Message	Action
Tire Pressure Low	After inflating your tires to the manufacturer's recommended pressure as shown on the tire label, on the edge of the driver door or the B-pillar, drive your vehicle for at least two minutes over 20 mph (32 km/h) before the light turns off.
Tire Pressure Monitor Fault	The system has detected a fault that requires service. Have your vehicle checked as soon as possible.
Tire Pressure Sensor Fault	The system has detected a fault that requires service or a spare tire is in use. Have your vehicle checked as soon as possible.

Changing a Road Wheel

CHANGING A FLAT TIRE - GASOLINE



WARNING: Failure to follow these guidelines could result in an increased risk of loss of vehicle control, injury or death.



WARNING: Do not attempt to change a tire on the side of the vehicle close to moving traffic. Pull far enough off the road to not obstruct the flow of traffic and avoid the danger of being hit when operating the jack or changing the wheel.



WARNING: Switch the ignition off and apply the parking brake. If your vehicle has a manual transmission, shift into first or reverse gear. If your vehicle has an automatic transmission, shift into park (P).



WARNING: Make sure that your vehicle is on firm and level ground with the front wheels pointing straight ahead and set up a warning triangle if available.



WARNING: To help prevent your vehicle from moving when changing a wheel, use an appropriate block or wheel chock to secure the wheel diagonally opposite to the wheel being changed. For example, when changing the front left wheel, place an appropriate block or wheel chock on the right rear wheel.

Make sure all passengers are out of your vehicle.

Note: *The use of tire sealants can damage the tire pressure monitoring system.*

Note: *The tire pressure monitoring system indicator light illuminates when the spare tire is in use. To restore the full function of the monitoring system, all road wheels equipped with tire pressure monitoring sensors must be mounted on this vehicle.*

Note: *If your vehicle has a tire pressure monitoring system, the warning indicator flashes if you fit the spare wheel to your vehicle. To restore the correct operation of the tire pressure monitoring system, you must have the repaired road wheel and tire assembly refitted to your vehicle. See **Tire Pressure Monitoring System – Warning Lamps** (page 432). To prevent damage occurring to the tire pressure monitoring system sensors, make sure you have the damaged tire repaired or replaced by a tire professional.*

If the spare wheel is the same type and size as your vehicle road wheel, you can fit the spare wheel and continue to drive in the normal manner.

If the spare wheel is not the same type and size as your vehicle road wheel, it has a label showing the maximum driving speed limit.

If the spare wheel is not the same type and size as your vehicle road wheel we recommend installing the temporary spare wheel and tire on the front axle.

The spare wheel is under the rear of your vehicle.

You can obtain replacement locking wheel nuts or a locking wheel nut key using the reference number certificate.

The locking wheel nut key is in the glove box or in the storage compartment in the front right-hand side stepwell.

Changing a Road Wheel

Van, Bus or Wagon



E145138

1. Open the rear doors and remove the grommet.



2. Insert the square end of the wheel nut wrench or the short arm of the jack handle into the socket. Turn counterclockwise until the spare wheel rests on the ground and the cable is loose enough to allow the spare wheel to be pulled from under the vehicle.



E146811

3. Raise the cable end cover.



E146812

4. Rotate the cable through 90°. Slide the cable through the slot to release the spare wheel bracket from the winch.

Changing a Road Wheel

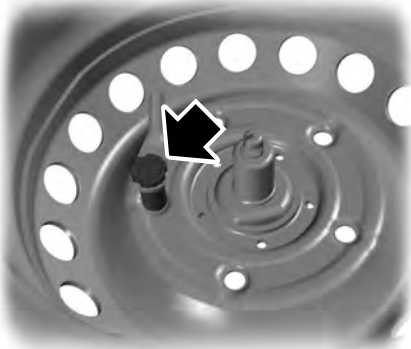

E146813

5. Remove the retaining nut to release the spare wheel bracket.
6. Leave the cable extended. You need to use it to stow the flat wheel and tire assembly.

Note: Do not raise the spare wheel bracket without a wheel attached. Damage to the winch mechanism could occur.

Chassis Cab and Cutaway

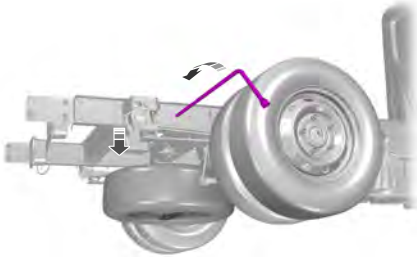

1. Insert the square end of the wheel nut wrench or the short arm of the jack handle into the socket. Turn counterclockwise until the spare wheel rests on the ground and the cable is loose enough to allow the spare wheel to be pulled from under the vehicle.



E146811

2. Raise the cable end cover.

Changing a Road Wheel



E146812

3. Rotate the cable through 90°. Slide the cable through the slot to release the spare wheel bracket from the winch.

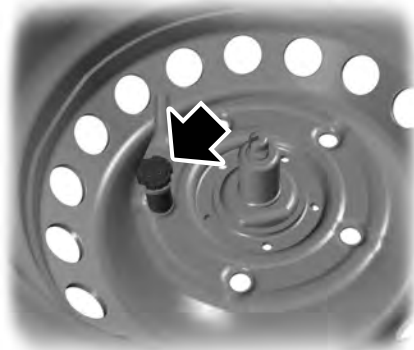

E146813

4. Remove the retaining nut to release the spare wheel bracket.
5. Leave the cable extended. You need to use it to stow the flat wheel and tire assembly.

Note: Do not raise the spare wheel bracket without a wheel attached. Damage to the winch mechanism could occur.

Vehicle Jack

 **WARNING:** Only use the jack provided as original equipment with your vehicle.

 **WARNING:** The jack supplied with this vehicle is only intended for changing a flat tire in an emergency. Do not attempt to do any other work on your vehicle when it is supported by the jack, as your vehicle could slip off the jack. Failure to follow this instruction could result in personal injury or death.

 **WARNING:** Switch off the running boards before jacking or placing any object under your vehicle. Never place your hand between the extended running board and your vehicle. A moving running board may cause injury.

 **WARNING:** Never place anything between the vehicle jack and your vehicle.

 **WARNING:** Never place anything between the vehicle jack and the ground.

 **WARNING:** Do not get under a vehicle that is supported by a jack.

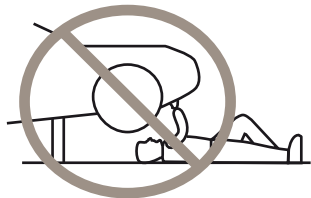

Changing a Road Wheel

Vehicle Jack Storage

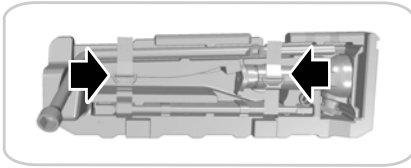

The jack, jack handle and wheel nut wrench are in a storage compartment in the front right-hand side stepwell.

Note: The vehicle jack is in the load space area on vehicles with rear climate control.



1. Assemble the jack handle.
2. Insert the jack handle into the jack.

3. Insert the end of the jack handle into the wheel nut wrench and rotate clockwise to raise your vehicle.

Front Jacking Points



WARNING: Only use the specified jacking points. If you use any other locations you could damage vehicle components, such as brake lines.



WARNING: No person should place any portion of their body under a vehicle that is supported by a jack.

Note: If your vehicle has rear air conditioning make sure the vehicle jack does not come in contact with the air conditioning lines.

Changing a Road Wheel

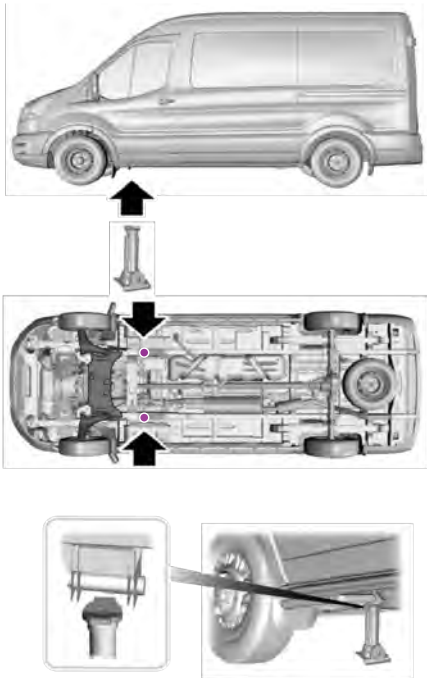

Position the head of the vehicle jack under the protrusions at the rear of front sub-frame.

Rear Jacking Points

⚠ WARNING: Only use the specified jacking points. If you use any other locations you could damage vehicle components, such as brake lines.

⚠ WARNING: No person should place any portion of their body under a vehicle that is supported by a jack.

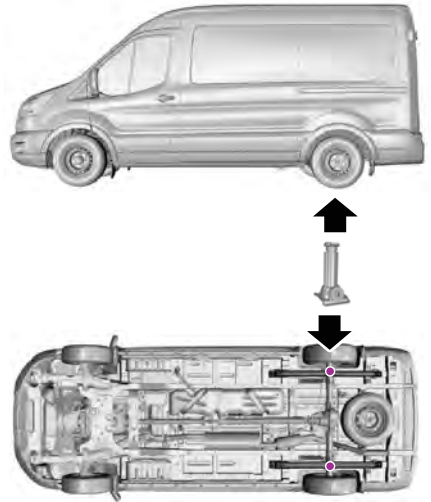

Position the head of the vehicle jack under the rear axle.

Changing a Road Wheel

Removing a Wheel Trim (If Equipped)

Vehicles With Steel Wheels

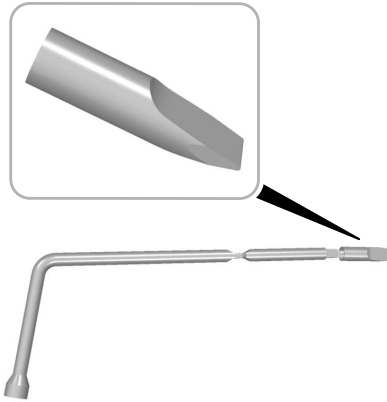

1. Assemble the wheel trim removal tool onto the square end of the wheel nut wrench. The tool is in the storage compartment in the front right-hand side stepwell near the wheel nut wrench.
2. Insert the tip of the assembled tool between the wheel rim and the wheel trim.
3. Carefully remove the wheel trim.

Vehicles With Dual Rear Alloy Wheels

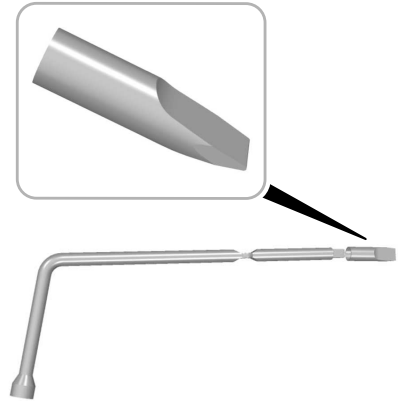

1. Assemble the wheel trim removal tool onto the square end of the wheel nut wrench. The tool is in the storage compartment in the front right-hand side stepwell near the wheel nut wrench.
2. Insert the tip of the assembled tool between the wheel rim and the wheel trim.
3. Carefully remove the wheel trim.

Changing a Road Wheel

Front Wheel Trim

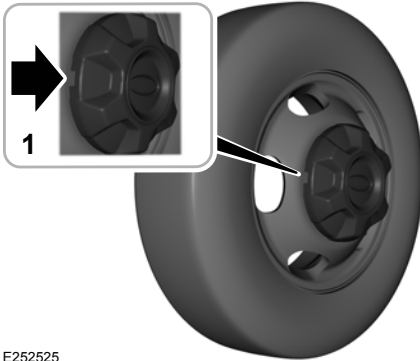

E252525

1. Locate the notch in the wheel trim.

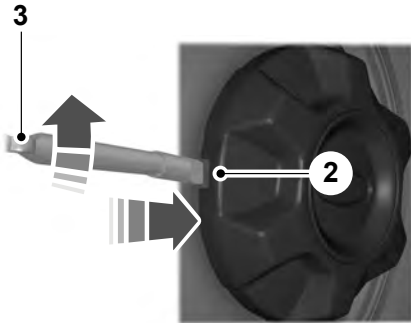

2. Insert the wheel trim removal tool into the notch in the wheel trim.
3. Rotate the wheel trim removal tool and remove the wheel trim.

Rear Wheel Trim

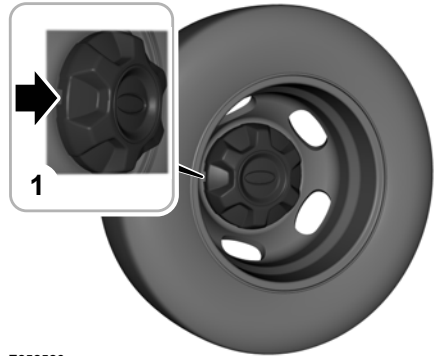

E252526

1. Locate the notch in the wheel trim.

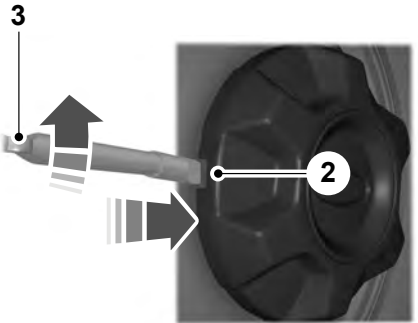

2. Insert the wheel trim removal tool into the notch in the wheel trim.
3. Rotate the wheel trim removal tool and remove the wheel trim.

Removing a Road Wheel

1. Use the locking wheel nut key to loosen the locking wheel nut.

Changing a Road Wheel

2. Loosen the remaining wheel nuts, but do not remove them.
3. Raise your vehicle until the tire is clear of the ground.
4. Remove the wheel nuts and the road wheel.

Note: Do not lay alloy road wheels face down on the ground.

Installing a Road Wheel



WARNING: Only use the spare wheel and tire assembly provided as original equipment with your vehicle.



WARNING: Make sure there is no grease or oil on the threads or the surface between the wheel studs and the wheel nuts. This can cause the wheel nuts to loosen while driving.



WARNING: When you install a wheel, remove any corrosion, dirt or foreign materials present on the mounting surfaces of the wheel or the surface of the wheel hub, brake drum or brake disc that contacts the wheel. Make sure to secure any fasteners that attach the rotor to the hub so they do not interfere with the mounting surfaces of the wheel. Installing wheels without following these steps can cause the wheel nuts to loosen and the wheel to come off while your vehicle is in motion, resulting in loss of vehicle control, personal injury or death.



WARNING: Have the wheel nuts checked for tightness and the tire pressure checked as soon as possible.

1. Install the wheel.

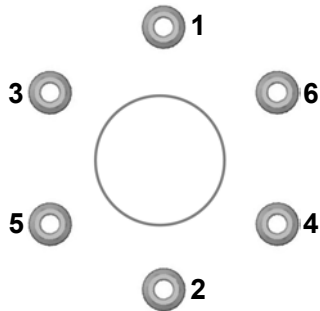
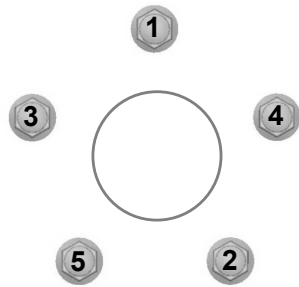

E70961

2. Install all of the wheel nuts and partially tighten them in the sequence shown.
3. Lower your vehicle and remove the vehicle jack.
4. Fully tighten all of the wheel nuts in the sequence shown. See **Locating the Tire label** (page 410).
5. Install the wheel trim.

Note: Make sure that the wheel nuts are fully seated against the wheel.

Note: Alloy wheel wheel nuts are suitable for use on a steel spare wheel.

Changing a Road Wheel

Note: If the spare wheel is not the same type and size as your vehicle road wheel replace it as soon as possible.

Note: Check the wheel nuts for correct tightness and check the tire pressure as soon as possible. See **Locating the Tire label** (page 410).

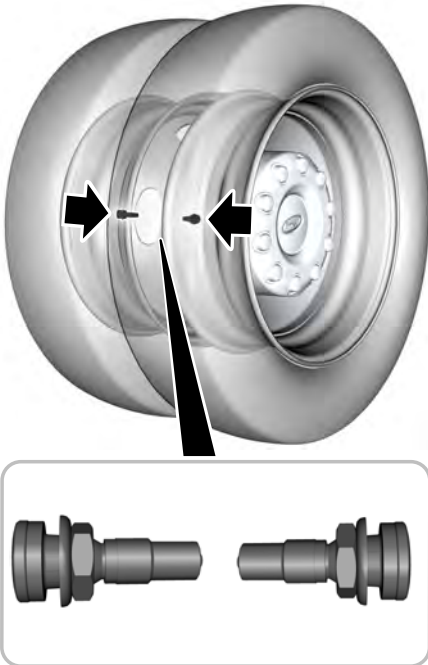

Note: When installing dual rear wheels, align the valve stems facing each other.

Stowing the Wheel and Vehicle Jack

Note: Do not raise the spare wheel bracket without a wheel attached. If you lower the spare wheel bracket without a wheel attached, you may damage the winch mechanism.

1. Attach the spare wheel bracket to the wheel using the retaining nut.
2. Slide the cable through the slot and attach the spare wheel bracket to the winch.
3. Rotate the cable through 90° and lower the cable end cover.



E145138

4. Insert the square end of the wheel nut wrench into the socket. Turn an additional 90° once you feel a strong resistance.

Note: Make sure the spare wheel is secure by tightening the winch until you feel a slip.

Note: Make sure the wheel is securely stowed in the spare wheel well to avoid issues when driving.

5. Reinstall the grommet, stow the vehicle jack, jack handle and wheel nut wrench in their correct locations and secure them with the straps.

Changing a Road Wheel

CHANGING A FLAT TIRE - BATTERY ELECTRIC VEHICLE



WARNING: Failure to follow these guidelines could result in an increased risk of loss of vehicle control, injury or death.



WARNING: Do not attempt to change a tire on the side of the vehicle close to moving traffic. Pull far enough off the road to not obstruct the flow of traffic and avoid the danger of being hit when operating the jack or changing the wheel.



WARNING: Switch the ignition off and apply the parking brake. If your vehicle has a manual transmission, shift into first or reverse gear. If your vehicle has an automatic transmission, shift into park (P).



WARNING: Make sure that your vehicle is on firm and level ground with the front wheels pointing straight ahead and set up a warning triangle if available.



WARNING: To help prevent your vehicle from moving when changing a wheel, use an appropriate block or wheel chock to secure the wheel diagonally opposite to the wheel being changed. For example, when changing the front left wheel, place an appropriate block or wheel chock on the right rear wheel.

Make sure all passengers are out of your vehicle.

Note: *The use of tire sealants can damage the tire pressure monitoring system.*

Note: *The tire pressure monitoring system indicator light illuminates when the spare tire is in use. To restore the full function of the monitoring system, all road wheels equipped with tire pressure monitoring sensors must be mounted on this vehicle.*

Note: *If your vehicle has a tire pressure monitoring system, the warning indicator flashes if you fit the spare wheel to your vehicle. To restore the correct operation of the tire pressure monitoring system, you must have the repaired road wheel and tire assembly refitted to your vehicle. See **Tire Pressure Monitoring System – Warning Lamps** (page 432). To prevent damage occurring to the tire pressure monitoring system sensors, make sure you have the damaged tire repaired or replaced by a tire professional.*

If the spare wheel is the same type and size as your vehicle road wheel, you can fit the spare wheel and continue to drive in the normal manner.

If the spare wheel is not the same type and size as your vehicle road wheel, it has a label showing the maximum driving speed limit.

If the spare wheel is not the same type and size as your vehicle road wheel we recommend installing the temporary spare wheel and tire on the front axle.

The spare wheel is under the front of the vehicle on all battery electric vehicles except E-LWB van, which is at the rear.

You can obtain replacement locking wheel nuts or a locking wheel nut key using the reference number certificate.

The locking wheel nut key is in the glove box or in the storage compartment in the front right-hand side stepwell.

Changing a Road Wheel

Van and E-LWB Van

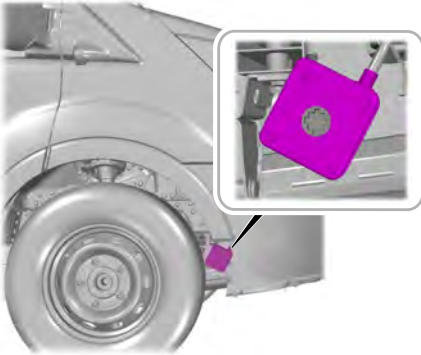

If you have a van, find the winch on the chassis rail in front of the right side front wheel.



E145138

If you have E-LWB van, open the rear doors and remove the grummet.



1. Insert the square end of the wheel nut wrench or the short arm of the jack handle into the socket. Turn counterclockwise until the spare wheel rests on the ground and the cable is loose enough to allow the spare to be pulled from under the vehicle.

Note: *In case of a flat tire on the front it could be necessary to jack your vehicle to reach and withdraw the spare wheel. Withdraw the spare wheel by holding the tread.*

Changing a Road Wheel



E146811

2. Raise the cable end cover.



E146812

3. Rotate the cable through 90°. Slide the cable through the slot to release the spare wheel bracket from the winch.



E146813

4. Remove the retaining nut to release the spare wheel bracket.
5. Leave the cable extended. You need to use it to stow the flat wheel and tire assembly.

Note: Do not raise the spare wheel bracket without a wheel attached. Damage to the winch mechanism could occur.

Vehicle Jack



WARNING: Only use the jack provided as original equipment with your vehicle.



WARNING: The jack supplied with this vehicle is only intended for changing a flat tire in an emergency. Do not attempt to do any other work on your vehicle when it is supported by the jack, as your vehicle could slip off the jack. Failure to follow this instruction could result in personal injury or death.

Changing a Road Wheel

 **WARNING:** Switch off the running boards before jacking or placing any object under your vehicle. Never place your hand between the extended running board and your vehicle. A moving running board may cause injury.

 **WARNING:** Never place anything between the vehicle jack and your vehicle.

 **WARNING:** Never place anything between the vehicle jack and the ground.

 **WARNING:** Do not get under a vehicle that is supported by a jack.

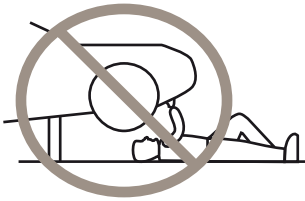

Vehicle Jack Storage

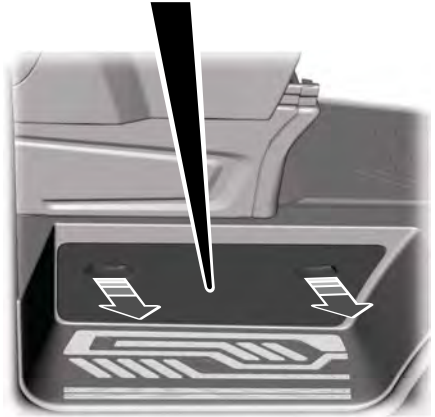
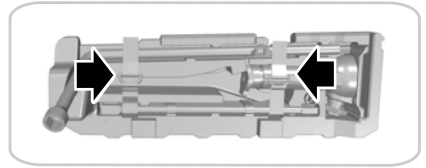

The jack, jack handle and wheel nut wrench are in a storage compartment in the front right-hand side stepwell.

Note: *The vehicle jack is in the load space area on vehicles with rear climate control.*

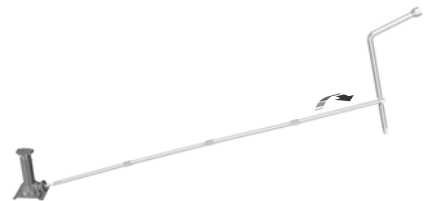

1. Assemble the jack rod.
2. Insert the flat end of the jack rod into the jack.

Changing a Road Wheel

3. Insert the square end of the jack rod into the wheel nut wrench and rotate clockwise to raise your vehicle.

Front Jacking Points

WARNING: Only use the specified jacking points. If you use any other locations you could damage vehicle components, such as brake lines.

WARNING: Using the high voltage battery box as a jacking point could result in electric shock, personal injury, fire or death.

WARNING: No person should place any portion of their body under a vehicle that is supported by a jack.

Note: If your vehicle has rear air conditioning make sure the vehicle jack does not come in contact with the air conditioning lines.

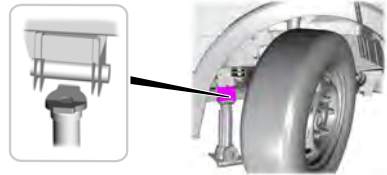
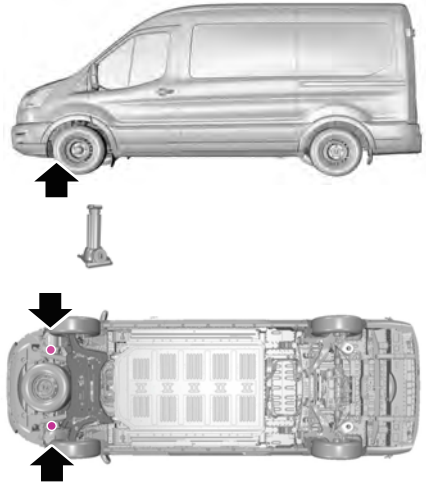

Position the head of the vehicle jack on the bolted body brackets.

Rear Jacking Points Vehicles

WARNING: Only use the specified jacking points. If you use any other locations you could damage vehicle components, such as brake lines.

Changing a Road Wheel



WARNING: Using the high voltage battery box as a jacking point could result in electric shock, personal injury, fire or death.



WARNING: No person should place any portion of their body under a vehicle that is supported by a jack.

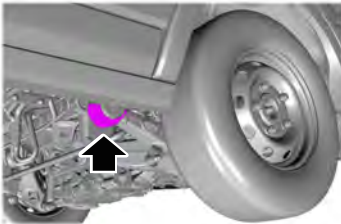
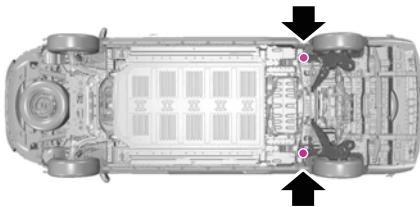
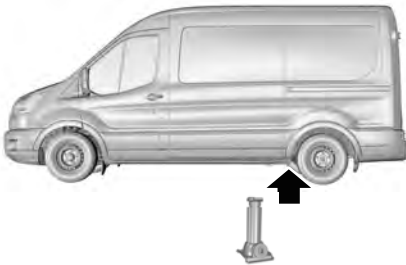

Position the head of the vehicle jack under the outer bush of the suspension arm.

Removing a Wheel Trim (If Equipped)

Vehicles With Steel Wheels

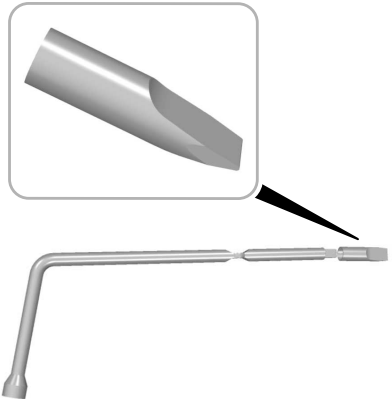

1. Assemble the wheel trim removal tool onto the square end of the wheel nut wrench. The tool is in the storage compartment in the front right-hand side stepwell near the wheel nut wrench.
2. Insert the tip of the assembled tool between the wheel rim and the wheel trim.
3. Carefully remove the wheel trim.

Removing a Road Wheel

1. Use the locking wheel nut key to loosen the locking wheel nut.
2. Loosen the remaining wheel nuts, but do not remove them.
3. Raise your vehicle until the tire is clear of the ground.
4. Remove the wheel nuts and the road wheel.

Changing a Road Wheel

Note: Do not lay alloy road wheels face down on the ground.

Installing a Road Wheel

 **WARNING:** Only use the spare wheel and tire assembly provided as original equipment with your vehicle.

 **WARNING:** Make sure there is no grease or oil on the threads or the surface between the wheel studs and the wheel nuts. This can cause the wheel nuts to loosen while driving.

 **WARNING:** When you install a wheel, remove any corrosion, dirt or foreign materials present on the mounting surfaces of the wheel or the surface of the wheel hub, brake drum or brake disc that contacts the wheel. Make sure to secure any fasteners that attach the rotor to the hub so they do not interfere with the mounting surfaces of the wheel. Installing wheels without following these steps can cause the wheel nuts to loosen and the wheel to come off while your vehicle is in motion, resulting in loss of vehicle control, personal injury or death.

 **WARNING:** Have the wheel nuts checked for tightness and the tire pressure checked as soon as possible.

1. Install the wheel.

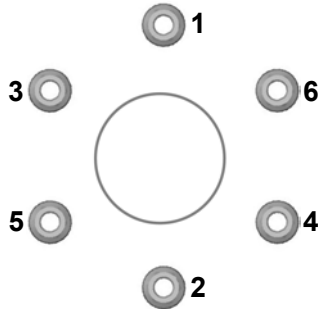
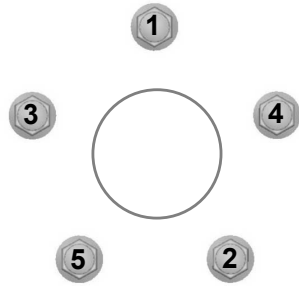

E70961

2. Install all of the wheel nuts and partially tighten them in the sequence shown.
3. Lower your vehicle and remove the vehicle jack.
4. Fully tighten all of the wheel nuts in the sequence shown. See **Locating the Tire label** (page 410).
5. Install the wheel trim.

Note: Make sure that the wheel nuts are fully seated against the wheel.

Note: Alloy wheel wheel nuts are suitable for use on a steel spare wheel.

Changing a Road Wheel

Note: If the spare wheel is not the same type and size as your vehicle road wheel replace it as soon as possible.

Note: Check the wheel nuts for correct tightness and check the tire pressure as soon as possible. See **Locating the Tire label** (page 410).

Stowing the Wheel and Vehicle Jack

Note: Do not raise the spare wheel bracket without a wheel attached. If you lower the spare wheel bracket without a wheel attached, you may damage the winch mechanism.

1. Attach the spare wheel bracket to the wheel using the retaining nut.
2. Slide the cable through the slot and attach the spare wheel bracket to the winch.
3. Rotate the cable through 90° and lower the cable end cover.
4. Insert the square end of the wheel nut wrench into the socket. Turn an additional 90° once you feel a strong resistance.

Note: Make sure the spare wheel is secure by tightening the winch until you feel a slip.

Note: Make sure that the wheel is securely stowed in the spare wheel well and it is not loose to avoid issues when driving.

5. Stow the vehicle jack, jack handle and wheel nut wrench in their correct locations and secure them with the straps.

WHEEL NUTS

Lug Nut Torque



WARNING: When you install a wheel, remove any corrosion, dirt or foreign materials present on the mounting surfaces of the wheel or the surface of the wheel hub, brake drum or brake disc that contacts the wheel. Make sure to secure any fasteners that attach the rotor to the hub so they do not interfere with the mounting surfaces of the wheel. Installing wheels without following these steps can cause the wheel nuts to loosen and the wheel to come off while your vehicle is in motion, resulting in loss of vehicle control, personal injury or death.



WARNING: Only use the specific lug nuts and wheels supplied with your vehicle. If in doubt, contact an authorized dealer.



WARNING: Do not install alloy wheels using lug nuts designed for use with steel wheels.

Bolt size	lb.ft (Nm)
M14 x 1.5	150 (204)

Locking Lug Nuts

You can obtain a replacement locking lug nut key and replacement locking lug nuts from an authorized dealer using the reference number certificate.

Capacities and Specifications

ENGINE SPECIFICATIONS - 3.5L DURATEC

Engine	3.5L V6 TiVCT
Cubic inches.	213
Required fuel.	Minimum 87 octane
Firing order.	1-4-2-5-3-6
Ignition system.	Coil on plug
Spark plug gap.	.049-.053 in. (1.25 - 1.35 mm)
Compression ratio.	11.8:1

Capacities and Specifications

ENGINE SPECIFICATIONS - 3.5L ECOBOOST™

Engine	3.5L V6 EcoBoost™
Cubic inches.	213
Required fuel.	Minimum 87 octane
Firing order.	1-4-2-5-3-6
Ignition system.	Coil on plug
Spark plug gap.	.030-.033 in. (.75-.85 mm)
Compression ratio.	10.0:1

Capacities and Specifications

MOTORCRAFT PARTS - 3.5L DURATEC

Component	Motorcraft Part number
Air filter element.	FA-1916
Automatic transmission fluid filter.	FT-216
Battery.	BAGM-48H6-760
Oil filter.	FL-500S
Spark plugs.	SP-589
Cabin air filter.	FP-74
Windshield wiper blades - roof med-low.	WW-2955-A - driver side WW-2112-A - passenger side
Windshield wiper blades - roof low, medium and high.	WW-2901-A - driver side WW-2049-A - passenger side

We recommend Motorcraft replacement parts available at your Ford dealer or at fordparts.com for scheduled maintenance. These parts meet or exceed Ford Motor Company's specifications and are engineered for your vehicle. Use of other parts may impact vehicle performance, emissions and durability. Your warranty may be void for any damage related to use of other parts.

If a Motorcraft oil filter is not available, use an oil filter that aligns to SAE/USCAR – 36 Performance Specifications. Filter Type C.

For spark plug replacement, contact an authorized dealer. Replace the spark plugs at the appropriate intervals. See **Normal Scheduled Maintenance** (page 530).

Capacities and Specifications

MOTORCRAFT PARTS - 3.5L ECOBOOST™

Component	Motorcraft Part number
Air filter element.	FA-1916
Automatic transmission fluid filter.	FT-216
Battery.	BAGM-48H6-760
Oil filter.	FL-500S
Spark plugs.	SP-580-X
Cabin air filter.	FP-74
Windshield wiper blades - roof med-low.	WW-2955-A - driver side WW-2112-A - passenger side
Windshield wiper blades - roof low, medium and high.	WW-2901-A - driver side WW-2049-A - passenger side

We recommend Motorcraft replacement parts available at your Ford dealer or at fordparts.com for scheduled maintenance. These parts meet or exceed Ford Motor Company's specifications and are engineered for your vehicle. Use of other parts may impact vehicle performance, emissions and durability. Your warranty may be void for any damage related to use of other parts.

If a Motorcraft oil filter is not available, use an oil filter that aligns to SAE/USCAR – 36 Performance Specifications. Filter Type C.

For spark plug replacement, contact an authorized dealer. Replace the spark plugs at the appropriate intervals. See **Normal Scheduled Maintenance** (page 530).

Capacities and Specifications

MOTORCRAFT PARTS - BATTERY ELECTRIC VEHICLE

Component	Motorcraft Part number
Battery.	BAGM-48H6-760
Cabin air filter.	FP-74
Windshield wiper blades - roof med-low.	WW-2955-A - driver side WW-2112-A - passenger side
Windshield wiper blades - roof low, medium and high.	WW-2901-A - driver side WW-2049-A - passenger side

We recommend Motorcraft replacement parts available at your Ford dealer or at fordparts.com for scheduled maintenance. These parts meet or exceed Ford Motor Company's specifications and are engineered for your vehicle. Use of other parts may impact vehicle performance, emissions and durability. Your warranty may be void for any damage related to use of other parts.

Capacities and Specifications

ENGINE OIL CAPACITY AND SPECIFICATION - 3.5L DURATEC



An oil that displays this symbol conforms to current engine, emission system and fuel economy performance standards of the International Lubricants Specification Advisory Committee (ILSAC).

We recommend Motorcraft® motor oil for your vehicle. If Motorcraft® oil is not available, use motor oils of the recommended viscosity grade that displays the API Certification Mark for gasoline engines.

Do not use supplemental engine oil additives because they are unnecessary and could lead to engine damage that may not be covered by the vehicle Warranty.

Capacities

Variant	Including the Oil Filter
All.	12.0 qt (11.4 L)

Note: The quantity of engine oil required to raise the indicated level on the dipstick from minimum to nominal is 2.0 qt (1.9 L).

Materials

Name	Specification
Motorcraft® SAE 5W-30 Motor Oil (U.S.) Motorcraft® SAE 5W-30 Motor Oil / Huile moteur SAE 5W-30 Motorcraft® (Canada) XO-5W30-Q1SP, XO-5W30-Q1FS (U.S.) CXO-5W30-LSP6, CXO-5W30-LFS6 (Canada)	WSS-M2C961-A1

Note: Do not use more than 0.26 gal (1 L) of the alternative engine oil between scheduled service intervals.

Alternative Engine Oil for Extremely Cold Climates

To improve engine cold start performance, we recommend that you use the following alternative engine oil where the ambient temperature reaches -22°F (-30°C) or below.

Capacities and Specifications

Materials

Name	Specification
Engine Oil - SAE 0W-30	WSS-M2C963-A1

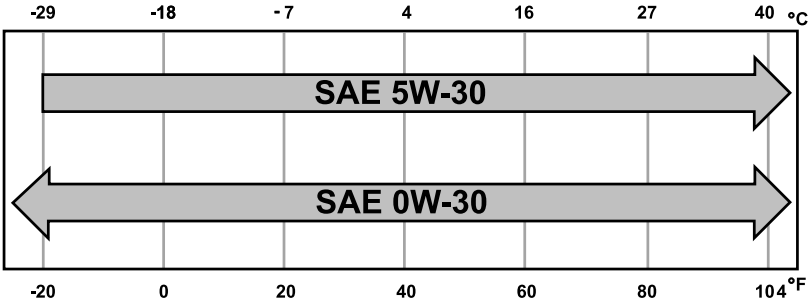

Note: If you use your vehicle regularly above the altitude of 5,000.0 ft (1,524 m) and below the temperature of -4.0°F (-20°C), it is recommended to use the alternative engine oil.

ENGINE OIL CAPACITY AND SPECIFICATION - 3.5L ECOBOOST™



An oil that displays this symbol conforms to current engine, emission system and fuel economy performance standards of the International Lubricants Specification Advisory Committee (ILSAC).

We recommend Motorcraft® motor oil for your vehicle. If Motorcraft® oil is not available, use motor oils of the recommended viscosity grade that displays the API Certification Mark for gasoline engines.

Do not use supplemental engine oil additives because they are unnecessary and could lead to engine damage that may not be covered by the vehicle Warranty.

Capacities and Specifications

Capacities

Variant	Including the Oil Filter
All.	6.0 qt (5.7 L)

Note: The quantity of engine oil required to raise the indicated level on the dipstick from minimum to nominal is 1.0 qt (0.9 L).

Materials

Name	Specification
Motorcraft® SAE 5W-30 Motor Oil (U.S.) Motorcraft® SAE 5W-30 Motor Oil / Huile moteur SAE 5W-30 Motorcraft® (Canada) XO-5W30-Q1SP, XO-5W30-Q1FS (U.S.) CXO-5W30-LSP6, CXO-5W30-LFS6 (Canada)	WSS-M2C961-A1

Note: Do not use more than 0.26 gal (1 L) of the alternative engine oil between scheduled service intervals.

Alternative Engine Oil for Extremely Cold Climates

To improve engine cold start performance, we recommend that you use the following alternative engine oil where the ambient temperature reaches -22°F (-30°C) or below.

Materials

Name	Specification
Engine Oil - SAE 0W-30	WSS-M2C963-A1

Capacities and Specifications

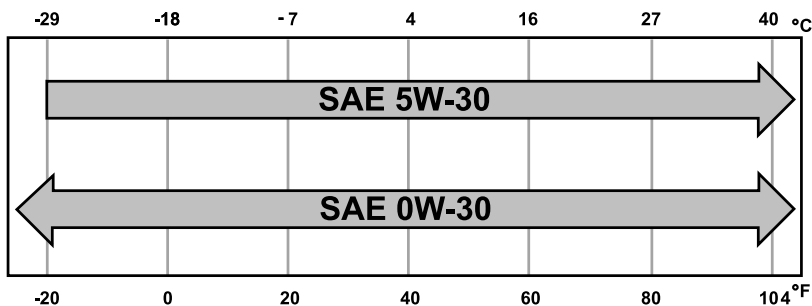

Note: If you use your vehicle regularly above the altitude of 5,000.0 ft (1,524 m) and below the temperature of -4.0°F (-20°C), it is recommended to use the alternative engine oil.

COOLING SYSTEM CAPACITY AND SPECIFICATION - 3.5L DURATEC

Capacities

Variant	Quantity
Vehicles with auxiliary heater.	13.21 qt (12.5 L)
Vehicles without auxiliary heater.	12.26 qt (11.6 L)

Materials

Name	Specification
Motorcraft® Yellow Prediluted Antifreeze/Coolant (U.S.) Motorcraft® Yellow Prediluted Antifreeze/Coolant / Antigél/liquide de refroidissement prédilué jaune Motorcraft® (Canada) VC-13DL-G (U.S.) CVC-13DL-G (Canada)	WSS-M97B57-A2

Capacities and Specifications

COOLING SYSTEM CAPACITY AND SPECIFICATION - 3.5L ECOBOOST™

Capacities

Variant	Quantity
Vehicles with auxiliary heater.	14.27 qt (13.5 L)
Vehicles without auxiliary heater.	13.31 qt (12.6 L)

Materials

Name	Specification
Motorcraft® Yellow Prediluted Antifreeze/ Coolant (U.S.) Motorcraft® Yellow Prediluted Antifreeze/Coolant / Antigel/liquide de refroidissement prédilué jaune Motorcraft® (Canada) VC-13DL-G (U.S.) CVC-13DL-G (Canada)	WSS-M97B57-A2

COOLING SYSTEM CAPACITY AND SPECIFICATION - BATTERY ELECTRIC VEHICLE

HV Battery Cooling Loop

Capacities

Variant	Quantity
Van	7.82 qt (7.4 L)
Chassis Cab	8.24 qt (7.8 L)

Capacities and Specifications

Materials

Name	Specification
Motorcraft® Yellow Prediluted Antifreeze/ Coolant(U.S.) Motorcraft® Yellow Prediluted Antifreeze/Coolant / Antigel/liquide de refroidissement prédilué jaune Motorcraft®(Canada) VC-13DL-G(U.S.) CVC-13DL-G(Canada)	WSS-M97B57-A2

Motor and Electronics Cooling Loop

Capacities

Variant	Quantity
Van, Medium Wheel Base, with 2.3kW or 2.4kW Power Outlet	10.04 qt (9.5 L)
Van, Medium Wheel Base, without 2.3kW or 2.4kW Power Outlet	9.40 qt (8.9 L)
Van, Long Wheel Base, with 2.3kW or 2.4kW Power Outlet	10.46 qt (9.9 L)
Van, Long Wheel Base, without 2.3kW or 2.4kW Power Outlet	9.83 qt (9.3 L)
Chassis Cab, with 2.3kW or 2.4kW Power Outlet	11.31 qt (10.7 L)
Chassis Cab, without 2.3kW or 2.4kW Power Outlet	9.93 qt (9.4 L)

Materials

Name	Specification
Motorcraft® Yellow Prediluted Antifreeze/ Coolant(U.S.) Motorcraft® Yellow Prediluted Antifreeze/Coolant / Antigel/liquide de refroidissement prédilué jaune Motorcraft®(Canada) VC-13DL-G(U.S.) CVC-13DL-G(Canada)	WSS-M97B57-A2

Capacities and Specifications

FUEL TANK CAPACITY - 3.5L DURATEC

Capacities

Variant	Quantity
Vehicles with standard fuel tank.	25.1 gal (95 L)
Vehicles with larger fuel tank.	30.5 gal (115.4 L)

Capacities and Specifications

FUEL TANK CAPACITY - 3.5L ECOBOOST™

Capacities

Variant	Quantity
Vehicles with standard fuel tank.	25.1 gal (95 L)
Vehicles with larger fuel tank.	30.5 gal (115.4 L)

Capacities and Specifications

AIR CONDITIONING SYSTEM CAPACITY AND SPECIFICATION - GASOLINE



WARNING: The air conditioning

refrigerant system contains refrigerant under high pressure. Only qualified personnel should service the air conditioning refrigerant system. Opening the air conditioning refrigerant system can cause personal injury.

Capacities

Variant	Refrigerant	Refrigerant Oil
Vehicles with rear air conditioning.	50.3 oz (1.425 kg)	7.4 fl oz (220 ml)
Vehicles without rear air conditioning.	30.0 oz (0.85 kg)	3.7 fl oz (110 ml)

Materials

Name	Specification
Motorcraft® R-134a Refrigerant(U.S.) R-134a Refrigerant / Frigorigène R-134a(Canada) YN-19(U.S.) CYN-19-RB(Canada)	WSH-M17B19-A
Motorcraft® PAG Refrigerant Compressor Oil(U.S.) Motorcraft® PAG Refrigerant Compressor Oil / Huile PAG pour compresseur frigorifique Motor- craft®(Canada) YN-12-D(U.S. & Canada)	WSH-M1C231-B

Capacities and Specifications

AIR CONDITIONING SYSTEM CAPACITY AND SPECIFICATION - BATTERY ELECTRIC VEHICLE, VEHICLES WITH: STANDARD RANGE BATTERY



WARNING: The air conditioning refrigerant system contains refrigerant under high pressure. Only qualified personnel should service the air conditioning refrigerant system. Opening the air conditioning refrigerant system can cause personal injury.

Capacities

Variant	Refrigerant	Refrigerant Oil
All.	31.7 ± 1.0 oz (0.9 ± 0.02835 kg)	5.7 fl oz (170 ml)

Materials

Name	Specification
Motorcraft® R-134a Refrigerant (U.S.) R-134a Refrigerant / Frigorigène R-134a (Canada) YN-19 (U.S.) CYN-19-RB (Canada)	WSH-M17B19-A
Motorcraft® POE Electric A/C Compressor Oil (U.S.) Motorcraft® POE Electric A/C Compressor Oil / Huile d'ester à base de polyol pour compresseur de climatiseur électrique Motorcraft® (Canada) YN-50 (U.S. & Canada)	WSS-M2C31-B2

Capacities and Specifications

AIR CONDITIONING SYSTEM CAPACITY AND SPECIFICATION - VEHICLES BUILT FROM: 03/2024, BATTERY ELECTRIC VEHICLE, VEHICLES WITH: EXTENDED RANGE BATTERY



WARNING: The air conditioning refrigerant system contains refrigerant under high pressure. Only qualified personnel should service the air conditioning refrigerant system. Opening the air conditioning refrigerant system can cause personal injury.

Capacities

Variant	Refrigerant	Refrigerant Oil
Vehicles with heat pump.	44 ± 1 oz (1.25 ± 0.02835 kg)	8.5 fl oz (250 ml)
Vehicles without heat pump.	32 ± 1 oz (0.9 ± 0.02835 kg)	5.7 fl oz (170 ml)

Materials

Name	Specification
Motorcraft® R-134a Refrigerant(U.S.) R-134a Refrigerant / Frigorigène R-134a(Canada) YN-19(U.S.) CYN-19-RB(Canada)	WSH-M17B19-A
Motorcraft® POE Electric A/C Compressor Oil(U.S.) Motorcraft® POE Electric A/C Compressor Oil / Huile d'ester à base de polyol pour compresseur de climatiseur électrique Motorcraft®(Canada) YN-50(U.S. & Canada)	WSS-M2C31-B2

WASHER FLUID SPECIFICATION

Capacities

Variant	Quantity
All.	Fill as required.

Capacities and Specifications

Materials

Name	Specification
Motorcraft® Premium Windshield Wash Concentrate with Bitterant(U.S.) Motorcraft® Premium Quality Windshield Washer Fluid -35 °C / Liquide lave-glace de haute qualité -35 °C Motorcraft®(Canada) ZC-32-B2(U.S.) CXC-37-M(Canada)	WSS-M14P19-A

BRAKE FLUID SPECIFICATION

Materials

Name	Specification
Motorcraft® DOT 4 LV High Performance Motor Vehicle Brake Fluid(U.S.) Motorcraft® DOT 4 LV High Performance Motor Vehicle Brake Fluid / Liquide de frein automobile haute performance DOT 4 LV Motorcraft®(Canada) PM-20(U.S. & Canada)	WSS-M6C65-A2

Note: We recommend using DOT 4 LV (Low Viscosity) High Performance Brake Fluid meeting WSS-M6C65-A2 or ISO 4925 Class 6 standards. Use of any fluid other than the recommended fluid could cause reduced brake performance and not meet our performance standards. Keep brake fluid clean and dry. Contamination with dirt, water, petroleum products or other materials could result in brake system damage and possible failure.

REAR AXLE FLUID CAPACITY AND SPECIFICATION - GASOLINE

Fluid changes or level checks are not required, unless a leak is suspected or the assembly has been submerged in water.

If submerged or suspecting a leak, have your vehicle checked by an authorized dealer.

Capacities and Specifications

Capacities

Variant	Quantity
Vehicles with limited slip differential.	2.1–2.2 qt (2.01–2.08 L)
Vehicles with conventional differential.	2.3–2.3 qt (2.13–2.2 L)
Rear axle friction modifier.	0.2–0.2 qt (148–178 ml)

Materials

Name	Specification
Motorcraft® SAE 75W-85 Premium Synthetic Hypoid Gear Lubricant(U.S.) Motorcraft® SAE 75W-85 Premium Synthetic Hypoid Gear Lubricant / Huile synthétique de haute qualité pour engrenages hypoides SAE 75W-85 Motorcraft®(Canada) XY-75W85-QL(U.S. & Canada)	WSS-M2C942-A
Motorcraft® Additive Friction Modifier(U.S.) Motorcraft® Additive Friction Modifier / Additif modificateur de friction Motorcraft®(Canada) XL-3(U.S. & Canada)	EST-M2C118-A

Vehicle Identification

VEHICLE IDENTIFICATION NUMBER

LOCATING THE VEHICLE IDENTIFICATION NUMBER

The vehicle identification number is on the left-hand side of the instrument panel.



Note: In the illustration, XXXX is representative of your vehicle identification number.

VEHICLE IDENTIFICATION NUMBER OVERVIEW

The vehicle identification number contains the following information:

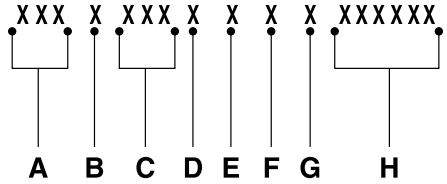

- A World manufacturer identifier.
- B Brake system, gross vehicle weight rating, restraint devices and their locations.
- C Make, vehicle line, series, body type.
- D Engine or motor type.
- E Check digit.
- F Model year.
- G Assembly plant.
- H Production sequence number.

Connected Vehicle

WHAT IS A CONNECTED VEHICLE - GASOLINE

A connected vehicle has technology that allows your vehicle to connect to a mobile network and for you to access a range of features. When used in conjunction with the FordPass app, it could allow you to monitor and control your vehicle further, for example checking the tire pressures, the fuel level and the vehicle location. For additional information, refer to the local Ford website.

WHAT IS A CONNECTED VEHICLE - BATTERY ELECTRIC VEHICLE

A connected vehicle has technology that allows your vehicle to connect to a mobile network and for you to access a range of features. When used in conjunction with the FordPass app, it could allow you to monitor and control your vehicle further, for example checking the tire pressures, and the vehicle location. For additional information, refer to the local Ford website.

CONNECTED VEHICLE REQUIREMENTS

Connected service and related feature functionality requires a compatible vehicle network.

Some remote features require additional service activation. Log in to your Ford account for details. Some restrictions, third party terms and message or data rates may apply.

CONNECTED VEHICLE LIMITATIONS

Evolving technology, cellular networks, or regulations could affect functionality and availability, or continued provision of some features. These changes could even stop some features from functioning.

CONNECTING THE VEHICLE TO A MOBILE NETWORK

WHAT IS THE MODEM



The modem allows access to a range of features built into your vehicle.

ENABLING AND DISABLING THE MODEM - VEHICLES WITHOUT: SYNC

1. Using the information display controls on the steering wheel, select **Settings**.
2. Select **FordPass Connect**.
3. Select **Connectivity**.
4. Switch connectivity features on or off.

ENABLING AND DISABLING THE MODEM - VEHICLES WITH: SYNC 3 LITE

1. Select **Settings**.
2. Select **Connectivity Features**.
3. Select **Data sharing**.
4. Switch connectivity features on or off.

ENABLING AND DISABLING THE MODEM - VEHICLES WITH: SYNC 4

1. Press **Settings** on the touchscreen.

Connected Vehicle

2. Press **Connectivity**.
3. Press **Connected Vehicle Features**.
4. Switch vehicle connectivity on or off.

CONNECTING FORDPASS TO THE MODEM

1. Make sure that the modem is enabled using the vehicle settings menu.
2. Open the FordPass app on your device and log in.
3. Add your vehicle or select your vehicle if already added.
4. Select the option to activate your vehicle.
5. Make sure that the name on the screen matches the name shown in your FordPass account.
6. Confirm that FordPass account is connected to the modem.

CONNECTING THE VEHICLE TO A WI-FI NETWORK - VEHICLES WITH: SYNC 4

1. Press **Settings** on the touchscreen.
2. Press **Connectivity**.
3. Press **Manage Wi-Fi Networks**.
4. Switch **Wi-Fi** on.
5. Press **View Available Networks**.
6. Select an available Wi-Fi network.

Note: Enter the network password to connect to a secure network.

CONNECTING THE VEHICLE TO A WI-FI NETWORK - VEHICLES WITH: SYNC 3 LITE

1. Press **Settings**.
2. Press **Autom. system updates**.

3. Press **Wi-Fi connection**.
4. Switch **Wi-Fi** on.
5. Press **Available networks**.
6. Select an available Wi-Fi network.

Note: Enter the network password to connect to a secure network.

CONNECTED VEHICLE – TROUBLESHOOTING

CONNECTED VEHICLE – FREQUENTLY ASKED QUESTIONS - VEHICLES WITH: SYNC 4

Why can I not confirm the connection of my FordPass account to the modem?

- The modem is not enabled. Switch vehicle connectivity on.
- The network signal is weak. Move your vehicle closer to a place where the network signal is not obstructed.

Why can I not connect to a Wi-Fi network?

- You entered the wrong network password. Enter the correct password.
- The network signal is weak. Move your vehicle closer to the Wi-Fi router or to a place where the network signal is not obstructed.
- There are multiple access points in range with the same network name. Choose a unique name for your network. Do not use the default name unless it contains a unique identifier, for example as part of the MAC address.

Connected Vehicle

Why does the Wi-Fi connection disconnect after successful connection?

- The network signal is weak. Move your vehicle closer to the Wi-Fi router or to a place where the network signal is not obstructed.

What can I do if I am close to a Wi-Fi router but the network signal strength is weak?

- If your vehicle has a heated windshield, position your vehicle so that the windshield is not facing the Wi-Fi router.
- If your vehicle has metallic tinting on the windows but not on the windshield, position your vehicle so that the windshield is facing the Wi-Fi router or open the windows that are facing the router.
- If your vehicle has metallic tinting on the windows and the windshield, open the windows that are facing the router.
- If your vehicle is in a garage and you have the garage door closed, open the garage door as it could block the signal.

Why can I not see a network I expect to see in the list of available networks?

- The network is hidden. Make the network visible and try again, or manually add a network in the Wi-Fi settings menu.
- Some network security types are not supported, for example WEP.

Why do software downloads take too long?

- The network signal is weak. Move your vehicle closer to the Wi-Fi router or to a place where the network signal is not obstructed.
- Wi-Fi network is in high demand or has a slow Internet connection. Use a more reliable Wi-Fi network.

Why does the software not update when the system seems to connect to a Wi-Fi network and the signal strength is excellent?

- No software update is available at this time.
- Select automatic updates option in the settings menu to enable automatic software update or contact an authorized dealer.
- There could be a connection problem. Test the network using another device.

CONNECTED VEHICLE – FREQUENTLY ASKED QUESTIONS - VEHICLES WITH: SYNC 3 LITE

Why can I not confirm the connection of my FordPass account to the modem?

- The modem is not enabled. Switch vehicle connectivity on.
- The network signal is weak. Move your vehicle closer to a place where the network signal is not obstructed.

Connected Vehicle

Why can I not connect to a Wi-Fi network?

- You entered the wrong network password. Enter the correct password.
- The network signal is weak. Move your vehicle closer to the Wi-Fi router or to a place where the network signal is not obstructed.
- There are multiple access points in range with the same network name. Choose a unique name for your network. Do not use the default name unless it contains a unique identifier, for example as part of the MAC address.

Why does the Wi-Fi connection disconnect after successful connection?

- The network signal is weak. Move your vehicle closer to the Wi-Fi router or to a place where the network signal is not obstructed.

What can I do if I am close to a Wi-Fi router but the network signal strength is weak?

- If your vehicle has a heated windshield, position your vehicle so that the windshield is not facing the Wi-Fi router.
- If your vehicle has metallic tinting on the windows but not on the windshield, position your vehicle so that the windshield is facing the Wi-Fi router or open the windows that are facing the router.
- If your vehicle has metallic tinting on the windows and the windshield, open the windows that are facing the router.
- If your vehicle is in a garage and you have the garage door closed, open the garage door as it could block the signal.

Why can I not see a network I expect to see in the list of available networks?

- The network is hidden. Make the network visible and try again, or manually add a network in the Wi-Fi settings menu.

Why do software downloads take too long?

- The network signal is weak. Move your vehicle closer to the Wi-Fi router or to a place where the network signal is not obstructed.
- Wi-Fi network is in high demand or has a slow Internet connection. Use a more reliable Wi-Fi network.

Why does the software not update when the system seems to connect to a Wi-Fi network and the signal strength is excellent?

- No software update is available at this time.
- Select automatic updates option in the settings menu to enable automatic software update or contact an authorized dealer.
- There could be a connection problem. Test the network using another device.

Vehicle Wi-Fi Hotspot (If Equipped)

CREATING A VEHICLE WI-FI HOTSPOT - VEHICLES WITH: SYNC 4

You can create a Wi-Fi hotspot in your vehicle and allow devices to connect to it for access to the Internet.

1. Press **Settings** on the touchscreen.
2. Press **Vehicle Hotspot**.

Note: The vehicle hotspot default setting is on.

3. Press **Settings**.
4. Press **Edit**.
5. Press **Hotspot Visibility**.

Note: The hotspot visibility default setting is on.

Finding the Wi-Fi Hotspot Name and Password

1. Press **Settings** on the touchscreen.
2. Press **Vehicle Hotspot**.
3. Press **Settings**.

Note: The network name is the hotspot name.

4. Press **Show Password**.

Connecting a Device to the Wi-Fi Hotspot

1. On your device, switch Wi-Fi on and select the hotspot from the list of available Wi-Fi networks.
2. When prompted, enter the password.

Purchasing a Data Plan

1. Connect a device to the hotspot.

Note: The vehicle network carrier's portal opens on your device.

2. If the portal does not open on your device, open a website and it redirects to the vehicle network carrier's portal.

Note: Secure websites do not redirect.

3. Follow the instructions on the carrier portal to purchase a plan.

Note: If you have an active plan, the system does not redirect to the vehicle network carrier's portal when you connect a device. Visit the vehicle network carrier's website to purchase more data.

Note: If data usage information is available in the vehicle hotspot menu, it is approximate.

Note: If you carry out a vehicle system reset, the system does not remove your vehicle from your vehicle network carrier's account. To remove your vehicle from the account, contact your vehicle network carrier.

Note: The vehicle network carrier provides Vehicle Hotspot services, subject to your vehicle network carrier agreement, coverage and availability.

CHANGING THE VEHICLE WI-FI HOTSPOT NAME OR PASSWORD - VEHICLES WITH: SYNC 4

1. Press **Settings** on the touchscreen.
2. Press **Vehicle Hotspot**.
3. Press **Settings**.
4. Press **Edit**.
5. Press **Change Network Name**.
6. Enter your required network name.
7. Press **Done**.
8. Press **Change Password**.
9. Enter your required password.
10. Press **Done**.

Vehicle Wi-Fi Hotspot (If Equipped)

Changing the Wi-Fi Hotspot Frequency

Note: *The Vehicle Hotspot frequency band is selectable depending upon your device capabilities. You will be unable to connect your device to the Vehicle Hotspot if it does not support the selected frequency band.*

1. Press **Settings** on the touchscreen.
2. Press **Vehicle Hotspot**.
3. Press **Settings**.
4. Press **Edit**.
5. Select a frequency.

VEHICLE WI-FI HOTSPOT – TROUBLESHOOTING

VEHICLE WI-FI HOTSPOT – FREQUENTLY ASKED QUESTIONS - VEHICLES WITH: SYNC 4

Why can I not see the Wi-Fi hotspot name when I search for Wi-Fi networks on my cell phone or other device?

- Make sure Wi-Fi hotspot visibility is on.
- The system does not provide a Wi-Fi hotspot at this time.
- Check what frequency the hotspot is transmitting in the vehicle hotspot settings menu. If the frequency is 5 GHz and your device cannot see the network, change the frequency to 2.4 GHz.

Audio System

AUDIO SYSTEM PRECAUTIONS



WARNING: Driving while distracted can result in loss of vehicle control, crash and injury. We strongly recommend that you use extreme caution when using any device that may take your focus off the road. Your primary responsibility is the safe operation of your vehicle. We recommend against the use of any hand-held device while driving and encourage the use of voice-operated systems when possible. Make sure you are aware of all applicable local laws that may affect the use of electronic devices while driving.

Listening to loud audio for long periods of time could damage your hearing.

SWITCHING THE AUDIO UNIT ON AND OFF



Press the button on the volume control.

SELECTING THE AUDIO SOURCE - VEHICLES WITHOUT: SYNC

Selecting the Radio



Press the button to select radio mode.

Press the button again to display the available radio sources. Repeatedly press the button to scroll through the available radio sources.

Selecting Media



Press the button to select media mode.

Press the button again to display the available media sources. Repeatedly press the button to scroll through the available media sources.

SELECTING THE AUDIO SOURCE - VEHICLES WITH: SYNC 4

1. Select **Sources**.
2. Select the desired source by pressing the tile on the touchscreen.

SELECTING THE AUDIO SOURCE - VEHICLES WITH: SYNC 3 LITE



Select the audio option on the feature bar.

Select **Sources**.

Select the desired source.

PLAYING OR PAUSING THE AUDIO SOURCE



Press to pause playback. Press again to resume playback.

Note: *Not all sources can be paused.*

Audio System

ADJUSTING THE VOLUME

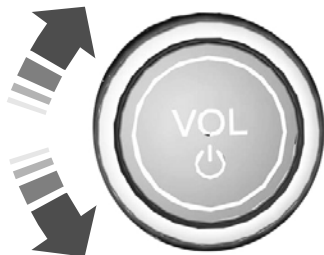

Turn to adjust the volume.

Some vehicles may be able to adjust the volume using buttons on the steering wheel.

SETTING A MEMORY PRESET

To store a radio station, press and hold one of the preset buttons.

Note: A maximum of thirty presets can be stored depending on the selected number of preset pages.

MUTING THE AUDIO



Press to mute the signal. Press again to restore the signal.

Note: The mute function is only available for sources that cannot be paused.



Press the button on the steering wheel to mute the signal. Press again to restore the signal.

SCROLLING THROUGH MENU ITEMS - VEHICLES WITH: SYNC 3 LITE, VEHICLES WITHOUT: SYNC



E248947

Use the rotary control or the touchscreen to scroll through menu items.

SCROLLING THROUGH MENU ITEMS - VEHICLES WITH: SYNC 4

Use the touchscreen to scroll through menu items.

Audio System

SELECTING A MENU ITEM - VEHICLES WITH: SYNC 3 LITE, VEHICLES WITHOUT: SYNC



E248946

Use the rotary control or the touchscreen to select a menu item.

Returning to the Previous Screen



SELECTING A MENU ITEM - VEHICLES WITH: SYNC 4

Use the touchscreen to select a menu item.

ADJUSTING THE SOUND SETTINGS - VEHICLES WITH: SYNC 3 LITE, VEHICLES WITHOUT: SYNC



Press the button to adjust the sound settings. You can optimize the sound for different seating positions.

You can also activate and set the sensitivity of the speed compensated volume.

ADJUSTING THE SOUND SETTINGS - VEHICLES WITH: SYNC 4

1.  Press the settings icon on the touchscreen.
2. Press **Sound Settings**.
3. Select the desired menu point and adjust the settings.

SETTING THE CLOCK AND DATE - VEHICLES WITHOUT: SYNC



Press the button.

Select the clock and follow the instructions on the screen.

SETTING THE CLOCK AND DATE - VEHICLES WITH: SYNC 4

1. Press **Settings** on the touchscreen.
2. Press **Clock Settings**.
3. Set the time.

Note: The **AM** and **PM** options are not available if **24-hour mode** is on.

Switching Automatic Time Updates On and Off

1. Press **Settings** on the touchscreen.
2. Press **Clock Settings**.

Audio System

3. Switch **Auto Time Update** on or off.

SETTING THE CLOCK AND DATE - VEHICLES WITH: SYNC 3 LITE



Select the settings option on the feature bar.

1. Select **Clock**.
2. Adjust the clock.

AM/FM RADIO

AM/FM RADIO LIMITATIONS

The further you travel from an AM or FM station, the weaker the signal and the weaker the reception.

Hills, mountains, tall buildings, bridges, tunnels, freeway overpasses, parking garages, dense tree foliage and thunderstorms can interfere with the reception.

When you pass a ground-based broadcast repeating tower, a stronger signal may overtake a weaker one and result in the audio system muting.

SELECTING AN AM/FM RADIO STATION - VEHICLES WITH: SYNC 3 LITE, VEHICLES WITHOUT: SYNC

Manually Changing Radio Stations



E248947

Use the rotary control or the touchscreen to change radio stations.

Note: You can recall radio stations using the preset buttons.

Automatically Changing Radio Stations



Press to seek the next station up the frequency band.

Press and hold to quickly seek up the frequency band.



Press to seek the next station down the frequency band.

Press and hold to quickly seek down the frequency band.



Press the button on the steering wheel to switch to the next preset.

Press and hold to seek the next station up the frequency band.

Audio System



Press the button on the steering wheel to switch to the previous preset.

Press and hold to seek the next station down the frequency band.

Selecting a Station from the List

Press the **OK** button to view available stations.

Note: *Station list is only available for FM.*

SELECTING AN AM/FM RADIO STATION - VEHICLES WITH: SYNC 4

Manually Changing Radio Stations

Use the touchscreen to change radio stations.

Note: *You can recall radio stations using the preset buttons.*

Automatically Changing Radio Stations



Press to seek the next station up the frequency band.

Press and hold to quickly seek up the frequency band.



Press to seek the next station down the frequency band.

Press and hold to quickly seek down the frequency band.



Press the button on the steering wheel to switch to the next preset.

Press and hold to seek the next station up the frequency band.



Press the button on the steering wheel to switch to the previous preset.

Press and hold to seek the next station down the frequency band.

Selecting a Station from the List

Press **Stations** on the touchscreen to view available stations.

Note: *Station list is only available for FM.*

SWITCHING THE DISPLAY ON AND OFF - VEHICLES WITH: SYNC 3 LITE, VEHICLES WITHOUT: SYNC



Press the button.

SWITCHING THE DISPLAY ON AND OFF - VEHICLES WITH: SYNC 4



Press the button on the touchscreen.

DIGITAL RADIO

WHAT IS DIGITAL RADIO

HD Radio™ technology is the digital evolution of analog AM/FM radio.

For additional information, visit www.HDRadio.com.

Audio System

HD Radio Technology is manufactured under license from iBiquity Digital Corporation and foreign patents. HD Radio and the HD and HD Radio logos are proprietary trademarks of XPERI. The vehicle manufacturer and XPERI are not responsible for the content sent using HD Radio technology. Content may be changed, added or deleted at any time at the station owner's discretion.

HOW DOES DIGITAL RADIO WORK

Your system has a special receiver that allows it to receive digital broadcasts in addition to analog broadcasts.

HD1 signifies the main programming status and is available in both analog and digital broadcasts. Other multicast stations are only available digitally and could contain new or different content.

Note: *When the system first receives an HD1 station, it plays the station in the analog version until it verifies the station is an HD Radio station. Then it shifts to the digital version.*

Note: *There is an audio mute delay when switching to an HD2 or HD3 station because the system has to reacquire and decode the digital signal.*

DIGITAL RADIO LIMITATIONS

If you are outside the reception area, the system could not work.

If you are on the fringe of the reception area, the station could mute due to weak signal strength.

Note: *If you are listening to HD1, the system changes back to the analog broadcast until the digital broadcast is available again. If you are listening to any other multicast channels, the station mutes and stays muted unless it is able to connect to the digital signal again.*

Depending on the station quality, you could hear a slight sound change when the station changes between analog and digital audio.

You cannot access a saved HD station if your vehicle is outside the station's reception area.

DIGITAL RADIO INDICATORS

HD Radio Indicator

The indicator appears when HD Radio is on and you tune to a station broadcasting HD Radio technology.



The color of the indicator changes to indicate the system status.

Gray indicates the system is acquiring a digital station.

Orange indicates digital audio is playing.

Multicast Indicator

The multicast indicator appears if the current station is broadcasting multiple digital broadcasts. The highlighted numbers indicate additional digital channels available.

Note: *For stations that have more than one HD multicast, the HD indicator and radio text appears as a button. Press the button to cycle through all of the HD stations on that specific frequency.*

Audio System

SATELLITE RADIO

WHAT IS SATELLITE RADIO

Your factory-installed SiriusXM radio system includes a limited subscription term, which begins on the date of sale or lease of your vehicle. See an authorized dealer for availability.

For additional information about extended subscription terms, visit www.SiriusXM.com in the United States, www.SiriusXM.ca in Canada, or call SiriusXM at 1-888-539-7474.

Note: *SiriusXM reserves the unrestricted right to change, rearrange, add or delete programming including canceling, moving or adding particular channels, and its prices, at any time, with or without notice to you. Neither SiriusXM and its affiliates nor Ford Motor Company and its affiliates will be liable to you or any third party for any such modification, suspension or termination.*

SATELLITE RADIO LIMITATIONS

For optimal reception performance, keep the antenna clear of snow and ice build-up and keep luggage and other material as far away from the antenna as possible. Placing luggage over the antenna may reduce performance. Factory-installed and aftermarket vehicle structures including, but not limited to, roof racks and soft top roofs in a partially open position could reduce reception performance.

Hills, mountains, tall buildings, bridges, tunnels, freeway overpasses, parking garages, dense tree foliage and thunderstorms can interfere with your reception.

When you pass a ground-based broadcast-repeating tower, a stronger signal may overtake a weaker one and could result in the audio system muting. Your display could show an error message to indicate the interference.

LOCATING THE SATELLITE RADIO IDENTIFICATION NUMBER

1. Select SiriusXM as the audio source.
2. Tune to channel 0.

SATELLITE RADIO SETTINGS

Subscription

Your subscription status is displayed. You can subscribe or manage your subscription directly from the touchscreen.

SiriusXM Favorites

While you are listening to SiriusXM, you can save favorites by:

- Tapping the currently tuned channel or show logo on the SiriusXM audio screen.
- Tuning to a channel or show you want to save as a favorite. Navigate to the SiriusXM Favorites screen and press the Add Current button. The currently tuned channel or show is saved as a favorite.
- Saving a radio preset. This saves the currently tuned SiriusXM channel or show as a favorite

Note: *Requires a trial or active subscription to use.*

Listening History

Listening history is a list of recently listened to SiriusXM content. You can view, manage and reset the listening history using the controls on the touchscreen.

Audio System

Note: *Requires a trial or active subscription to use.*

Help and Support

You can contact SiriusXM Customer Care directly from the operating system and view information required to manage your SiriusXM account.

GENERAL INFORMATION

SYNC is an in-vehicle communications system that works with your Bluetooth enabled cellular phone and portable media player. This allows you to:

- Make and receive calls.
- Access and play music from your portable music player.
- Use 911 Assist or Emergency Assistance and applications via SYNC AppLink.*
- Access phonebook contacts and music using voice commands.
- Stream music from your connected phone.
- Text message.
- Use the advanced voice recognition system.
- Charge your USB device (if your device supports this).

*These features are not available in all markets and may require activation. Available AppLink enabled apps vary by market.

Make sure that you review your device's manual before using it with SYNC.

Support

SYNC support is available at your regional Ford website. See **SYNC™ Troubleshooting** (page 491).

SYNC Owner Account

Why do I need a SYNC owner account?

- Essential for keeping up with the latest software downloads available for SYNC.
- Access to customer support for any questions you may have.

Driving Restrictions

For your safety, certain features are speed-dependent and restricted when your vehicle is traveling over 3 mph (5 km/h).

Safety Information



WARNING: Driving while distracted can result in loss of vehicle control, crash and injury. We strongly recommend that you use extreme caution when using any device that may take your focus off the road. Your primary responsibility is the safe operation of your vehicle. We recommend against the use of any hand-held device while driving and encourage the use of voice-operated systems when possible. Make sure you are aware of all applicable local laws that may affect the use of electronic devices while driving.

When using SYNC:

- Do not operate playing devices if the power cords or cables are broken, split or damaged. Place cords and cables out of the way, so they do not interfere with the operation of pedals, seats, compartments or safe driving abilities.
- Do not leave playing devices in your vehicle during extreme conditions as it could cause them damage. See your device's manual for further information.
- Do not attempt to service or repair the system. See an authorized dealer.

Privacy Information

When a cellular phone is connected to SYNC, the system creates a profile within your vehicle that is linked to that cellular phone. This profile is created in order to offer you more cellular features and to operate more efficiently. Among other things, this profile may contain data about your cellular phone book, text messages

(read and unread), and call history, including history of calls when your cellular phone was not connected to the system. In addition, if you connect a media device, the system creates and retains an index of supported media content. The system also records a short development log of approximately 10 minutes of all recent system activity. The log profile and other system data may be used to improve the system and help diagnose any problems that may occur.

The cellular profile, media device index, and development log will remain in the vehicle unless you delete them and are generally accessible only in the vehicle when you connect the cellular phone or media player. If you no longer plan to use the system or the vehicle, we recommend you perform a Master Reset to erase all stored information.

No one can access system data without special equipment and access to the vehicle's SYNC module. Ford Motor Company and Ford of Canada will not access the system data for any purpose other than as described absent consent, a

court order, or where required by law enforcement, other government authorities, or other third parties acting with lawful authority. Other parties may seek to access the information independently of Ford Motor Company and Ford of Canada. For further privacy information, see the section on 911 Assist. See **SYNC™ Applications and Services** (page 489).

USING VOICE RECOGNITION

This system helps you control many features using voice commands. This allows you to keep your hands on the wheel and focus on what is around you.

Initiating a Voice Session



Press the voice button. A list of available voice commands appear in the display.

Global Voice Commands

These voice commands are always available. You can say them at any time.

Global Voice Commands	
Help	Gives you available commands you can use on the current screen.
List of Commands	Gives you a list of possible voice commands.
Cancel	This command ends the voice session. You can also cancel a session by pressing seek up, seek down, or holding the voice button for two or more seconds.

Helpful Hints

- Make sure the interior of your vehicle is as quiet as possible. Wind noise from open windows and road vibrations may prevent the system from correctly recognizing spoken commands.
- Before giving a voice command, wait for the system announcement to finish, followed by a single tone. Any command spoken before this does not register with the system.
- Speak naturally, without long pauses between words.
- You can interrupt the system at any time while it is speaking by pressing the voice button. You can cancel a voice session by pressing and holding the voice button.

System Interaction and Feedback

The system provides feedback through audible tones, prompts, questions and spoken confirmations depending on the situation and the chosen level of interaction. You can customize the voice recognition system to provide more or less instruction and feedback.

The default setting is to a higher level of interaction in order to help you learn to use the system. You can change these settings at any time.

Adjusting the Interaction Level



Press the voice button. When prompted, say:

Voice Command	Action and Description
Interaction Mode Standard	Provides more detailed interaction and guidance. (Recommended for first time users.)
Interaction Mode Advanced	Provides less audible interaction and guidance.

Phone Confirmation

Using phone confirmations; the system asks you to verify before placing any calls.

To adjust this setting press the voice button, when prompted say:

Voice Command	Action and Description
Phone Confirmation Off	When enabled, this feature prompts you to confirm any voice initiated call command prior to placing the call.
Phone Confirmation On	The system makes a best guess; occasionally, the system asks you to confirm settings.

USING SYNC™ WITH YOUR PHONE

Hands-free calling is one of the main features of SYNC. While the system supports a variety of features, many are dependent on your cellular phone's functionality. At a minimum, most cellular phones with Bluetooth wireless technology support the following functions:

- Answering an incoming call.
- Ending a call.
- Dialing a number.
- Redialing.
- Call waiting notification.
- Caller identification.

Other features, such as text messaging using **Bluetooth®** and automatic phonebook download, are phone-dependent features.

Pairing a Phone

Wirelessly pairing your phone with SYNC allows you to make and receive hands-free calls.

Note: *Make sure to switch on the ignition and the radio. Shift the transmission into park (P) for automatic transmission or neutral (N) for manual transmission.*

Using the Audio System

Note: *To scroll through the menus, press the up and down arrows on your audio system.*

1. Make sure to switch on your phone's **Bluetooth®** feature before starting the search. See your device's manual if necessary.
2. Press the **Settings** button.
3. Select Bluetooth from the menu.
4. Press the **OK** button.

5. Select the option to add. This starts the pairing process.
6. When a message to begin pairing appears in the center display, search for SYNC on your device.

Depending on your phone's capability and your market, the system may prompt you with questions, such as setting the current phone as the primary phone and downloading your phonebook.

Using Voice Commands



Make sure to switch on your phone's **Bluetooth®** feature before starting the search. See your device's manual if necessary.

Press the voice button and when prompted say:

Voice Command	Action and Description
Pair Phone	Follow the instructions on the center display.

Phone Voice Commands



Press the voice button. You can do things like place a phone call and access text messages. When prompted, say a command. See the following table for examples of commands.

Voice Command
___ List of Commands
Help
Call ___
Dial ___
Text Messages

__ is a dynamic listing, meaning that it could be the name of anything, such as a contact or phone number.

Phone Controls

Use the phone buttons on your steering wheel to answer, reject, or hang up a call.

Accessing Features through the Phone Menu

You can access your call history, phonebook, sent text messages, as well as access phone and system settings.

1. Press the **PHONE** button to enter the phone menu.
2. Scroll through the menu to view contacts, text messages, and the phone dialer.

SYNC™ APPLICATIONS AND SERVICES

- SYNC AppLink: Allows you to connect to and use certain applications (if your phone is compatible).

These features may require activation. Available AppLink enabled apps vary by market.

SYNC Mobile Apps

The system enables voice and steering wheel control of SYNC AppLink enabled smartphone apps. When an app is running through AppLink, you can control main features of the app through voice commands and steering wheel controls.

Note: You must pair and connect your smartphone to SYNC to access AppLink.

Note: Android users need to connect the phone to SYNC using **Bluetooth®**.

Note: For information on available apps, supported smartphone devices and troubleshooting tips please visit the Ford website.

Note: Availability of SYNC AppLink enabled Apps will vary by region.

Note: Make sure you have an active account for the app that you have downloaded. Some apps work automatically with no setup. Other apps want you to configure your personal settings and personalize your experience by creating stations or favorites. We recommend you do this at home or outside of your vehicle.

To Access Using the SYNC Menu

Press the Mobile Apps button to access the menu on-screen. Then select:

Menu Item	Action and Description
Find Mobile Apps	Scroll through the list of available applications and select a particular app.

Note: If you cannot find a compatible SYNC AppLink app, make sure the required app is running on the mobile device.

To Access Using Voice Commands

Press the voice button, then when prompted say:

Voice Command	Action and Description
Mobile Applications	Say the name of the application after the tone. The app should start. When an app is running through SYNC, you can press the voice button and speak commands specific to the app, for example "Play Playlist Road Trip".
List Applications	SYNC lists all of the currently available mobile apps.
Find Applications	Searches your connected mobile device for SYNC-compatible mobile apps.
Help	Use this command to discover the available voice commands.

App Permissions

App permissions are organized by groups. You can grant these group permissions individually. You can change a permission group status any time when not driving, by using the settings menu.

When you launch an app using SYNC, the system may ask you to grant certain permissions, for example:

- To allow your vehicle to provide vehicle information to the app such as, but not limited to: Fuel level, fuel economy, fuel consumption, engine speed, rain sensor, odometer, VIN, external temperature, gear position, tire pressure, and head lamp status.
- To allow your vehicle to provide driving characteristic information such as, but not limited to: MyKey, seatbelt status, engine revolutions per minute, gear position, braking events, steering wheel angle, and accelerator pedal position.

- To allow your vehicle to provide location information, including: GPS and speed.
- To allow the app to send push notifications using the vehicle display and voice capabilities while running in a background state. Push notifications may be particularly useful for news or location based apps.

Note: *You only need to grant permissions the first time you use an app with SYNC.*

Note: *Ford is not responsible or liable for any damages or loss of privacy relating to usage of an app, or dissemination of any vehicle data that you approve Ford to provide to an app.*

Enabling SYNC Mobile Apps

In order to enable mobile apps, SYNC requires user consent to send and receive app authorization information and updates using the data plan associated with the connected device.

Data is sent to Ford in the United States through the connected device. The information is encrypted and includes, for example, the vehicle identification number of your vehicle, the SYNC module serial number, odometer, enabled apps, usage statistics and debugging information. Updates may take place.

Note: You must enable mobile apps for each connected device the first time you select a mobile app using the system.

Note: Standard data rates apply. Ford is not responsible for any additional charges you may receive from your service provider, when your vehicle sends or receives data through the connected device. This includes any additional charges incurred due to driving in areas when roaming out of a home network.

USING SYNC™ WITH YOUR MEDIA PLAYER

SYNC supports digital media sources including: iPod, **Bluetooth®** devices, and most USB drives. SYNC also supports audio formats, such as MP3, WMA, WAV and ACC.

Media Sources

The **AUX** or **MEDIA** button allows you to view and select available media sources.

Press the **AUX** or **MEDIA** button to view your sources. Use the directional arrows and OK button to select your source. You can also use the steering wheel audio controls.

Audio Voice Commands



Press the voice button. You can do things like play a specific song or album, or tune to a radio station. When prompted, say a command. See the following table for example commands. Not all commands may be available on your vehicle.

Command
___ List of Commands
Help
Pause
Play
AM ___
FM ___
CD Player
Sirius Channel ___
USB
Bluetooth Audio

___ is a dynamic listing, meaning that it could be the name of anything, such as an artist, station, or media source.

SYNC™ TROUBLESHOOTING

Your SYNC system is easy to use. However, should questions arise, see the tables below.

Use your local Ford website at any time to check your phone's compatibility, register your account and set preferences as well as access a customer representative via an online chat (during certain hours).

SYNC™

Market	Website(s)
North America	www.SYNCMyRide.com www.SYNCMyRide.ca www.syncmaroute.ca

Phone Issues		
Issue	Possible Cause(s)	Possible Solution(s)
There is excessive background noise during a phone call.	The audio control settings on your phone may be affecting SYNC performance.	Review your phone's manual about audio adjustments.
During a call, I can hear the other person but they cannot hear me.	This may be a possible phone malfunction.	Try turning off the device, resetting the device, removing the device's battery, then trying again.
SYNC is not able to download my phonebook.	This is a phone-dependent feature. This may be a possible phone malfunction.	Go to the website to review your phone's compatibility. Try turning off the device, resetting the device or removing the device's battery, then trying again. Try pushing your phonebook contacts to SYNC by using the Add Contacts feature. Use the SYNCmyphone feature available on the website.
The system says Phonebook Downloaded but the phonebook in SYNC is empty or missing contacts.	This may be a limitation on your phone's capability.	Try pushing your phonebook contacts to SYNC by using the Add Contacts feature. If the missing contacts are stored on your SIM card, try moving them to the device memory.

SYNC™

Phone Issues		
Issue	Possible Cause(s)	Possible Solution(s)
		<p>Remove any pictures or special ring tones associated with the missing contact.</p> <p>Depending upon your phone, you may have to grant SYNC permission to access your phonebook contacts. Make sure to confirm when prompted by your phone during the phonebook download.</p>
<p>I am having trouble connecting my phone to SYNC.</p>	<p>This is a phone-dependent feature.</p> <p>This may be a possible phone malfunction.</p>	<p>Go to the website to review your phone's compatibility.</p> <p>Try turning off the device, resetting the device or removing the device's battery, then trying again.</p> <p>Try deleting your device from SYNC, deleting SYNC from your device and trying again.</p> <p>Check the security and auto accept and prompt always settings relative to the SYNC Bluetooth® connection on your phone.</p> <p>Update your device's firmware.</p> <p>Turn off the Auto phonebook download setting.</p>

SYNC™

Phone Issues		
Issue	Possible Cause(s)	Possible Solution(s)
Text messaging is not working on SYNC.	<p>This is a phone-dependent feature.</p> <p>This may be a possible phone malfunction.</p>	<p>Go to the website to review your phone's compatibility.</p> <p>Try turning off the device, resetting the device or removing the device's battery, then trying again.</p>
I cannot return to the Phone menu when selecting a contact.	You are on the Select a Character screen.	Press the Phone button to return to the Phone menu.

USB and Media Issues		
Issue	Possible Cause(s)	Possible Solution(s)
I am having trouble connecting my device.	This may be a possible device malfunction.	<p>Try turning off the device, resetting the device, removing the device's battery, then trying again.</p> <p>Make sure you are using the manufacturer's cable.</p> <p>Make sure you insert the USB cable correctly into the device and the USB port.</p> <p>Make sure that the device does not have an auto-install program or active security settings.</p>
SYNC does not recognize my device when I turn on the car.	This is a device limitation.	Make sure you are not leaving the device in your vehicle during very hot or cold temperatures.
Bluetooth® audio does not stream.	This is a phone-dependent feature.	Review the device compatibility chart on the SYNC website to confirm your phone supports the Bluetooth® audio streaming function.

SYNC™

USB and Media Issues		
Issue	Possible Cause(s)	Possible Solution(s)
	The device is not connected.	Make sure you correctly connect the device to SYNC, and that you have pressed play on your device.
SYNC does not recognize music that is on my device.	Your music files may not contain the correct artist, song title, album or genre information. The file may be corrupted. The song may have copy-right protection, which does not allow it to play.	Make sure that all song details are populated. Some devices require you to change the USB settings from mass storage to MTP class.
I cannot change the Sirius station.	Sirius Replay is active.	Switch radio bands and return to Sirius or switch the feature off. You can then change the Sirius station using the directional buttons.

Voice Command Issues		
Issue	Possible Cause(s)	Possible Solution(s)
SYNC does not understand what I am saying.	You may be using the wrong voice commands. You may be speaking too soon or at the wrong time.	Review the phone voice commands and the media voice commands at the beginning of their respective sections. After pressing the voice icon, wait until after the tone sounds and Listening appears before saying a command. Any command spoken before this does not register with the system.
SYNC does not understand the name of a song or artist.	You may be using the wrong voice commands.	Review the media voice commands at the beginning of the media section.

Voice Command Issues		
Issue	Possible Cause(s)	Possible Solution(s)
	<p>You may be saying the name differently than the way you saved it.</p> <p>The system may not be reading the name the same way you are saying it.</p>	<p>Say the song or artist exactly as listed. If you say "Play Artist Prince", the system does not play music by Prince and the Revolution or Prince and the New Power Generation.</p> <p>Make sure you are saying the complete title, such as "California remix featuring Jennifer Nettles".</p> <p>If the song titles are in all CAPS, you have to spell them. LOLA requires you to say "L-O-L-A".</p> <p>Do not use special characters in the title. The system does not recognize them.</p>
<p>SYNC does not understand or is calling the wrong contact when I want to make a call.</p>	<p>You may be using the wrong voice commands.</p> <p>You may be saying the name differently than the way you saved it.</p>	<p>Review the Phone voice commands at the beginning of the phone section.</p> <p>Make sure you are saying the contacts exactly as they are listed. For example, if you save a contact as Joe Wilson, say "Call Joe Wilson".</p> <p>Using the SYNC phone menu, open the phonebook and scroll to the name SYNC is having trouble understanding. SYNC will read the name to you, giving you some idea of the pronunciation SYNC is expecting.</p>

SYNC™

Voice Command Issues		
Issue	Possible Cause(s)	Possible Solution(s)
	<p>The system may not be reading the name the same way you are saying it.</p> <p>Contacts in your phonebook may be very short and similar, or they may contain special characters.</p> <p>Your phonebook contacts may be in CAPS.</p>	<p>The system works better if you list full names, such as "Joe Wilson" rather than "Joe".</p> <p>Do not use special characters, such as 123 or ICE, as the system does not recognize them.</p> <p>If a contact is in CAPS, you have to spell it. JAKE requires you to say "Call J-A-K-E".</p>

AppLink Issues		
Issue	Possible Cause(s)	Possible Solution(s)
<p>AppLink Mobile Applications: When I select "Find New Apps," SYNC does not find any applications.</p>	<p>An AppLink capable phone is not connected to SYNC.</p>	<p>Ensure you have a compatible smartphone; an Android with OS 2.3 or higher or an iPhone 3GS or newer with iOS 5.0 or higher. Additionally, ensure your phone is paired and connected to SYNC in order to find AppLink-capable apps on your device. iPhone users must also connect to SYNC's USB port with an Apple USB cable.</p>
<p>My phone is connected, but I still cannot find any apps.</p>	<p>AppLink-enabled apps are not installed and running on your mobile device.</p>	<p>Ensure you have downloaded and installed the latest version of the app from your phone's app store. Ensure the app is running on your phone. Some apps require you to register or</p>

SYNC™

AppLink Issues		
Issue	Possible Cause(s)	Possible Solution(s)
		login on the app on the phone before using them with AppLink. Also, some may have a Ford SYNC setting, so check the app's settings menu on the phone.
My phone is connected, my app(s) are running, but I still cannot find any apps.	Sometime apps do not properly close and re-open their connection to SYNC, over ignition cycles, for example.	<p>Closing and restarting apps may help SYNC find the application if you cannot discover it inside the vehicle.</p> <p>On an Android device, if apps have an Exit or Quit option, select that then restart the app. If the app does not have that option, you can also manually Force Close the app by going to the phone's settings menu, selecting Apps, then finding the particular app and choosing Force stop. Remember to restart the app afterwards, then select Find New Apps on SYNC.</p> <p>On an iPhone with iOS7+, to force close an app, double tap the home button then swipe up on the app to close it. Touch the home button again, then select the app again to restart it. After a few seconds, the app should appear in the SYNC Mobile App menu.</p>

SYNC™

AppLink Issues		
Issue	Possible Cause(s)	Possible Solution(s)
My Android phone is connected, my app(s) are running, I restarted them, but I still cannot find any apps.	There is a Bluetooth® bug on some older versions of the Android operating system that may cause apps that were found on your previous vehicle drive to not be found again if you have not turned off Bluetooth® .	Reset the Bluetooth® on your phone by turning it off and then turning Bluetooth® back on. If you are in your vehicle, SYNC should be able to automatically re-connect to your phone if you press the Phone button.
My iPhone phone is connected, my app is running, I restarted the app but I still cannot find it on SYNC.	The USB connection to SYNC may need to be reset.	Unplug the USB cable from the phone, wait a moment, and plug the USB cable back in to the phone. After a few seconds, the app should appear in SYNC's Mobile Apps Menu. If not, "Force Close" the application and restart it.
I have an Android phone. I found and started my media app on SYNC, but there is no sound or the sound is very low.	The Bluetooth® volume on the phone may be low.	Try increasing the Bluetooth® volume of the device by using the device's volume control buttons which are most often found on the side of the device.
I can only see some of the AppLink apps running on my phone listed in SYNC's Mobile Apps Menu.	Some Android devices have a limited number of Bluetooth® links apps can use to connect. If you have more AppLink apps on your phone than the number of available Bluetooth® links, you will not see all of your apps listed in SYNC's mobile apps menu.	Force close or uninstall the apps you do not want SYNC to find. If the app has a "Ford SYNC" setting, disable that setting in the app's settings menu on the phone.

SYNC System Reset

The SYNC system in your vehicle has System Reset feature that can be performed if the function of a SYNC feature is lost. This reset is intended to restore functionality and will not erase any information previously stored in the system (Such as paired devices, phonebook, call history, text messages, or user settings). To perform a System Reset, press and hold the Seek Up (>>) button while pressing and holding the Radio Power button. Release both buttons after 2-3 seconds. Please allow a few minutes for the reset to complete. After a few minutes has passed you can resume using the SYNC system.

Center Display Overview

CENTER DISPLAY PRECAUTIONS



WARNING: Driving while distracted can result in loss of vehicle control, crash and injury. We strongly recommend that you use extreme caution when using any device that may take your focus off the road. Your primary responsibility is the safe operation of your vehicle. We recommend against the use of any hand-held device while driving and encourage the use of voice-operated systems when possible. Make sure you are aware of all applicable local laws that may affect the use of electronic devices while driving.

CENTER DISPLAY LIMITATIONS

Speed-restricted Features

For your safety, some features are not available while the vehicle is in motion at or above 5 mph (8 km/h). Settings that are not critical while driving your vehicle are shown as restricted on your display. Some of these settings include:

- System updates.
- Driver assistance settings.

These restricted features become available when your vehicle is no longer in motion.

STATUS BAR

The bar is on top of the display and indicates the status of your vehicle's features.

Audio System



Audio system muted.

Connected Device



Cell phone microphone muted.



Phone call in progress.



Media player connected using **Bluetooth®**.



Cell phone network signal strength.



Cell phone roaming.



Text message received.



Unread email message.



Automatic crash notification system off.



Cell phone battery status.

Vehicle Data



Wi-Fi available.



Wi-Fi connected.



Vehicle data sharing on.

Center Display Overview



Vehicle data sharing off.



Vehicle location sharing on.



Vehicle data and vehicle location sharing on.

Vehicle Software Update

Wireless Accessory Charger



Wireless accessory charger active.

INFORMATION ON DEMAND SCREEN

The information on demand screen displays cards on the side of the display and allows you to see information from different features.

Swipe up and down to switch between the cards.

REBOOTING THE CENTER DISPLAY

You can reboot the center display using the controls on the steering wheel.

1. Simultaneously press and hold the seek forward and volume down button for 10 seconds.

Voice Interaction

WHAT IS VOICE INTERACTION

Voice Interaction allows you to control vehicle features using conversational requests.

SETTING THE WAKE WORD

1. Press **Settings** on the touchscreen.
2. Press **Ford Assistant**.
3. Switch **Listen for Wake Word** on.
4. Press **Preferred Wake Word**.
5. Press a setting.

BEGINNING A VOICE INTERACTION

Say the selected wake word followed by your command.



You can also press the button on the steering wheel to begin a voice interaction. A tone sounds before you can say your command.

Note: *If the wake word is not enabled, you can only use the voice interaction button.*

VOICE INTERACTION EXAMPLES

General Examples

Command	Result
Start Over.	The system resets the current voice interaction.
Cancel.	The system ends the current voice interaction.
Next Page.	The system goes to the next page.
Previous Page.	The system goes to the previous page.
Help.	The system displays a list of available commands you can use on the current screen.

Entertainment Examples

Command	Result
Play The Beatles.	The system plays the selected music.
Show music by The Beatles.	The system shows the selected music.
Tune to FM 101.9.	The system tunes the radio to 101.9 FM.
Set the station to Sirius Channel 2.	The system tunes the radio to Sirius Channel 2.

Voice Interaction

Climate Examples

Command	Result
Set the temperature to low.	The system sets the temperature to the minimum.
Set the temperature to 72°F (22°C).	The system sets the temperature to 72°F (22°C).

Phone Examples

Command	Result
Call Henry.	The system calls Henry using your connected device.
Dial (phone number).	The system dials the selected phone number.
Send a text message to Henry.	The system begins a dictated text message.
Read my message from Henry.	The system reads you the most recent message from Henry.

Apps Examples

Command	Result
Mobile Apps.	The system prompts you to say the name of an app to start it on the system.
List Mobile Apps.	The system will list all of the currently available Mobile Apps.
Find Mobile Apps	The system will search and connect to compatible apps running on your mobile device.

Navigation Examples

Command	Result
Say the address that you're looking for, like '125 Main Street, New York'.	The system begins guided navigation to the address.
Where is ___	The system searches for the requested point of interest.
Show me directions to Oakwood Boulevard and Pelham Road.	The system shows directions to the selected intersection.
Cancel route.	The system ends guided navigation to the destination.

Alexa Built-In

WHAT IS ALEXA BUILT-IN

Alexa Built-In allows you to use Alexa in your vehicle for auto-specific use cases on the road and gives you access to an ever-evolving number of skills that help to make your life more productive, entertaining, and connected while using your vehicle.

ALEXA BUILT-IN REQUIREMENTS

To use Alexa, all of the following must occur:

- Your vehicle modem is enabled.
- You are signed in to an existing Amazon account.
- Vehicle location services are enabled.
- Vehicle connectivity and vehicle data sharing is enabled.

SIGNING IN TO YOUR ACCOUNT



Press the button in the status bar and follow the on-screen prompts.

To sign in using the settings menu:

1. Press **Settings** on the touchscreen.
2. Press **Amazon Alexa**.
3. Press **Get Started**.
4. Sign in to your account by either scanning the QR code or entering the on-screen code into the Amazon website.
5. Once signed in, follow the on-screen prompts.
6. When complete, the vehicle informs you that Alexa is ready to be used in the vehicle.

Signing Out of Your Account

1. Press **Settings** on the touchscreen.
2. Press **Amazon Alexa**.
3. Press **Sign Out**.

USING ALEXA BUILT-IN

To use Alexa, say “Alexa” or press the voice interaction button on the steering wheel and then say “Alexa” to invoke Alexa to start listening.

Note: *If the wake word is not enabled, you can only use the voice interaction button.*

You can use Alexa for the following and more:

- Entertainment.
- Hands-free calling.
- Traffic and navigation.
- Vehicle controls.
- Smart home device control.
- Weather and news information.

ALEXA BUILT-IN SETTINGS

Enabling the Wake Word

1. Press **Settings** on the touchscreen.
2. Press **Amazon Alexa**.
3. Switch **Listen for Wake Word** on or off.

Note: *If the wake word is not enabled, you can only use the voice interaction button.*

Contact List

Displays a list of connected phones and contact sharing status for each phone.

To change the contact sharing status:

1. Press **Settings** on the touchscreen.
2. Press **Amazon Alexa**.
3. Press **Contact List**.

Alexa Built-In

4. Enable or disable sharing for each phone.

Note: *You can share contacts from more than one phone at a time.*

Things to Try

Learn more about what you can do with Alexa by browsing the things to try.

1. Press **Settings** on the touchscreen.
2. Press **Amazon Alexa**.
3. Press **Things to Try**.

Phone

PHONE PRECAUTIONS



WARNING: Driving while distracted can result in loss of vehicle control, crash and injury. We strongly recommend that you use extreme caution when using any device that may take your focus off the road. Your primary responsibility is the safe operation of your vehicle. We recommend against the use of any hand-held device while driving and encourage the use of voice-operated systems when possible. Make sure you are aware of all applicable local laws that may affect the use of electronic devices while driving.

CONNECTING YOUR PHONE

1. Make sure **Bluetooth**® is enabled on your device.
2. Press **Add Phone** on the touchscreen.

Note: *A prompt alerts you to search for your vehicle on your cell phone.*

3. Select your vehicle on your cell phone.

Note: *A number appears on your cell phone and on the touchscreen.*

4. Confirm the number on your cell phone matches the number on the touchscreen.

Note: *The touchscreen indicates that you have successfully paired your cell phone.*

5. Download the phonebook from your cell phone when you are prompted.

Note: *If you pair more than one cell phone, use the phone settings on the center display to specify the primary phone. You can change this setting at any time.*

PHONE MENU

This menu becomes available after pairing a phone.

Recent Call List

Display and select an entry from a list of previous calls.

Contacts

Display a smart search form to look up your contacts. Use the List button to alphabetically sort your contacts.

Favorites

Display the list of favorite contacts that are set up on your phone.

Messaging

Displays the list of text messages to read, listen to, or respond to.

Email

Displays the list of emails to read, listen to, or respond to.

Phone List

Display the list of paired or connected devices that you can select.

Note: *Up to 12 devices can be stored.*

Do Not Disturb

Reject incoming calls and switching ring tones and alerts off.

Phone Keypad

Directly dial a number.

Phone

Voice Control

Press the button and say a command to use the Google or Siri voice assistant available on your connected phone to access supported features.

Note: *Some features under the phone menu may not be available if the feature is not supported through the phone.*

Phone

MAKING AND RECEIVING A PHONE CALL

Making Calls

To call a number in your contacts, select:

Menu Item	Action and Description
Contacts	You can then select the name of the contact you want to call. Any numbers stored for that contact display along with any stored contact photos. You can then select the number that you want to call. The system begins the call.

To call a number from your recent calls, select:

Menu Item	Action and Description
Recent Call List	You can then select an entry that you want to call. The system begins the call.

To call a number from your favorites, select:

Menu Item	Action and Description
Favorites	You can then select an entry that you want to call. The system begins the call.

To call a number that is not stored in your phone, select:

Menu Item	Action and Description
Phone Keypad	Select the digits of the number you wish to call.
Call	The system begins the call.

Pressing the backspace button deletes the last digit you typed.

Receiving Calls

During an incoming call, an audible tone sounds. Caller information appears in the display if it is available.

To accept the call, select:

Menu Item
Accept

Note: You can also accept the call by pressing the phone button on the steering wheel.

To reject the call, select:

Menu Item
Reject

Ignore the call by doing nothing. The system logs it as a missed call.

During a Phone Call

During a phone call, the contacts name and number display on the screen along with the call duration.

The phone status items are also visible:

- Signal Strength.
- Battery.

You can select any of the following during an active phone call:

Phone

Item	
End Call	Immediately end a phone call. You can also press the button on the steering wheel.
Keypad	Press this to access the phone keypad.
Mute	You can switch the microphone off so the caller does not hear you.
Privacy	Transfer the phone call audio to the cell phone or back to the touchscreen.

SWITCHING TEXT MESSAGE NOTIFICATION ON AND OFF

IOS

1. Go to the settings menu on your cell phone.
2. Select **Bluetooth®**.
3. Select the information icon to the right of your vehicle.
4. Switch text message notification on or off.

Android

1. Go to the settings menu on your cell phone.
2. Select **Bluetooth®**.
3. Select the profiles option.
4. Select the phone profile.
5. Switch text message notification on or off.

Bluetooth®

CONNECTING A BLUETOOTH® DEVICE

1. Make sure **Bluetooth®** is enabled on your device.
2. Press **Add Phone** on the touchscreen.

Note: A prompt alerts you to search for your vehicle on your device.

3. Select your vehicle on your device.

Note: A number appears on your device and on the touchscreen.

4. Confirm that the number on your device matches the number on the touchscreen.

Note: The touchscreen indicates that you have successfully paired your device.

The **Bluetooth®** word mark and logos are registered trademarks owned by **Bluetooth SIG, Inc.** and any use of such marks by Ford Motor Company is under license. Other trademarks and trade names are those of their respective owners.

PLAYING MEDIA USING BLUETOOTH®



WARNING: Driving while distracted can result in loss of vehicle control, crash and injury. We strongly recommend that you use extreme caution when using any device that may take your focus off the road. Your primary responsibility is the safe operation of your vehicle. We recommend against the use of any hand-held device while driving and encourage the use of voice-operated systems when possible. Make sure you are aware of all applicable local laws that may affect the use of electronic devices while driving.

1. Connect your device.

2. Press the audio system tile on the touchscreen.

3. Press **Sources**.

4. Press **Bluetooth**.



Press to play a track. Press again to pause the track.



Press to skip to the next track.

Press and hold to fast forward through the track.



Press once to return to the beginning of a track. Repeatedly press to return to previous

tracks.

Press and hold to fast rewind through the track.

Apps

APP PRECAUTIONS



WARNING: Driving while distracted can result in loss of vehicle control, crash and injury. We strongly recommend that you use extreme caution when using any device that may take your focus off the road. Your primary responsibility is the safe operation of your vehicle. We recommend against the use of any hand-held device while driving and encourage the use of voice-operated systems when possible. Make sure you are aware of all applicable local laws that may affect the use of electronic devices while driving.

APP REQUIREMENTS

When you start an app through the system for the first time, you could be asked to grant certain permissions. You can review and change the permissions that you have granted at any time when your vehicle is not moving. We recommend that you check your data plan before using your apps through the system. Using them could result in additional charges. We also recommend that you check the app provider's terms and conditions and privacy policy before using their app. Make sure that you have an active account for apps that you want to use through the system. Some apps will work with no setup. Others require you to configure some personal settings before you can use them.

ENABLING APPS ON AN IOS DEVICE

1. Press **Apps** on the touchscreen.
2. Press **Mobile Apps Help**.

3. Follow the instructions to pair and connect your device via **Bluetooth®** or with a USB cable.

Note: *Some apps can run through **Apple CarPlay** if it is enabled.*

4. Start the apps on your device that you want to use.

Note: *The app must be open on your device to use it through the touchscreen.*

5. Select the app that you want to use on the touchscreen.

ENABLING APPS ON AN ANDROID DEVICE

1. Press **Apps** on the touchscreen.

2. Press **Mobile Apps Help**.

3. Follow the instructions to pair and connect your device via **Bluetooth®**.

Note: *Some apps can run through **Android Auto** if it is enabled.*

4. Start the apps on your device that you want to use.

Note: *The app must be open on your device to use it through the touchscreen.*

5. Access the system applications.

6. Select the app that you want to use on the touchscreen.

Note: *Some devices could lose the ability to play music over USB when **Mobile Apps** are enabled.*

SWITCHING APPLE CARPLAY ON AND OFF

Enabling Apple CarPlay with USB

1. Connect your device to a USB port.
2. Follow the instructions on your device and the touchscreen.

Apps

Note: Selecting "Enable Wireless CarPlay" on your device will prepare the device for wireless carplay when you re-enter the vehicle.

Enabling Wireless Apple CarPlay

1. Pair your device to **Bluetooth®**.
2. Follow the instructions on your device and the touchscreen.

Disabling Apple CarPlay

1. Press **Settings** on the touchscreen.
2. Press **Phone List**.
3. Select your device from the list.
4. Press **Disable**.

Re-Enabling Apple CarPlay

1. Press **Settings** on the touchscreen.
2. Press **Phone List**.
3. Select your device from the list.
4. Press **Connect to Apple CarPlay**.

SWITCHING ANDROID AUTO ON AND OFF

Enabling Android Auto with USB

1. Connect your device to a USB port.
2. Follow the instructions on the touchscreen.

Note: Certain features of the system are not available when you are using Android Auto.

Enabling Wireless Android Auto

1. Pair your device to **Bluetooth®**.
2. Follow the instructions on your device and the touchscreen.

Note: Certain Android Devices do not support Android Auto Wireless. Please check your Android OS version for compatibility.

Disabling Android Auto

1. Press **Settings** on the touchscreen.
2. Press **Phone List**.
3. Select your device from the list.
4. Press **Disable**.

Re-Enabling Android Auto

1. Press **Settings** on the touchscreen.
2. Press **Phone List**.
3. Select your device from the list.
4. Press **Connect to Android Auto**.

Navigation

CONNECTED NAVIGATION (IF EQUIPPED)

Your vehicle may have connected navigation as a free trial after purchase. You require a subscription after the trial expires. For additional information, visit ford.com/connectedservices.

Note: *If you do not sign up or renew your subscription, you can still use navigation through a connected device.*

ACCESSING NAVIGATION

1. Access Navigation by pressing the map on the left side of the homescreen.

Note: *As the driver, be aware of all local traffic regulations and road attributes, and operate your vehicle in a safe and legal manner.*

NAVIGATION MAP UPDATES

To update your map data over Wi-Fi, your vehicle must be connected to a Wi-Fi access point. For USB updates and other details, contact dealers at 1-866-462-8837 in the United States and Canada, or 800-557-5539 in Mexico.

Note: *If you find map data errors, you may report them by going to www.here.com/mapcreator.*

ADJUSTING THE MAP

ZOOMING THE MAP IN AND OUT

You can use pinch gestures to zoom in and out. Place two fingers on the screen and move them apart to zoom in. Place two fingers on the screen and bring them together to zoom out.

CHANGING THE FORMAT OF THE MAP

Press the map format button on the left side of the map screen to toggle between the available formats.

Note: *Available formats are 2D, 3D and North Up.*

LIVE TRAFFIC

WHAT IS LIVE TRAFFIC

You can observe real-time road congestion when live traffic is on.

SWITCHING LIVE TRAFFIC ON AND OFF

1. Press **Settings** on the touchscreen.
2. Press **Connectivity**.
3. Press **Connected Vehicle Features**.
4. Switch **Connected Navigation** on or off.

Note: *Switching off this feature disables all features of the **Connected Navigation**.*

SETTING A DESTINATION

SETTING A DESTINATION USING THE TEXT ENTRY SCREEN

1. Press Where To? at the top of the screen.
2. Press the search bar at the top of the screen.
3. Enter your destination using the keyboard.
4. Press Search.
5. Select a destination from the list.
6. Press the Go! button to begin navigation.

Navigation

SETTING A DESTINATION USING THE MAP SCREEN

1. Press on the map to trigger the roaming and viewing screen.
2. Press on the map again to place a pin at that location.

Note: *Information about the location of the pin appears on the screen.*

3. Press the **Go!** button to begin navigation to the pin.

SETTING A DESTINATION USING A PREDICTIVE DESTINATION

Press the predicted destination card on the screen to navigate to it. These appear when the navigation system has learned your driving habits.

SETTING A DESTINATION USING A RECENT DESTINATION

1. Press Where To? at the top of the screen.
2. Press the Recents tile.
3. Select a destination from the list.

SETTING A DESTINATION USING A SAVED DESTINATION

1. Press Where To? at the top of the screen.
2. Press Saved Places.
3. Select a saved destination.

Note: *Press the star icon next when viewing location details to save the location.*

SETTING A DESTINATION USING A POINT OF INTEREST

1. Press and hold on a point of interest icon on the map.

Note: *Information about the location of the point of interest appears on the screen.*

2. Press the **Go!** button to begin navigation to the point of interest.

WAYPOINTS

ADDING A WAYPOINT



Press the Add Waypoint button when in an active navigation session.

1. Enter your waypoint on the keyboard.
2. Press Search.
3. Select a waypoint from the list.
4. Press Add to Trip.

EDITING WAYPOINTS

1. Press the waypoint you would like to edit.
2. Select an option to reorder or delete the waypoint.

ROUTE GUIDANCE

ADJUSTING THE GUIDANCE PROMPT VOLUME

Turn the volume control when a guidance prompt plays to adjust the volume.

REPEATING AN INSTRUCTION

Press the turn indicator to hear the last voice instruction.

CANCELING ROUTE GUIDANCE



Press the button to cancel route guidance to the selected location.

Navigation

TRAILER TOWING NAVIGATION

The system calculates the best route for trailer towing by avoiding dangerous road conditions based on the dimensions of your trailer.

Switching Trailer Towing Navigation On and Off

1. Press the **Navigation** button on the feature bar.
2. Press the **Menu** button.
3. Press **Trailer Routing**.
4. Switch **Trailer-optimized Routing** on or off.

Entering Trailer Dimensions

1. Press the **Navigation** button on the feature bar.
2. Press the **Menu** button.
3. Press **Trailer Routing**.
4. Press **Towing Menu**.
5. Press **Add Trailer**.
6. Follow the instructions on the screen to enter the type and dimensions of the trailer into the system.

Navigation Alerts

Alerts will appear on the navigation map while driving. An orange alert triangle indicates you should proceed with caution. When not following active guidance to a destination, a red alert triangle may appear and indicates you should avoid the road and find a detour.

Driver Identification

HOW DOES DRIVER IDENTIFICATION WORK

Driver identification allows drivers to log into the vehicle using a specific user ID or profile.

SIGNING IN AS A DRIVER

1. Press **Features** on the touchscreen.

2. Press **Driver ID**.
3. Select or add a driver as necessary.
4. Follow the screen instructions and log in.

Configuring Your Driver ID Avatar

1. Log in with your user ID.
2. Press your avatar image.
3. Select the settings you prefer.

DRIVER IDENTIFICATION – TROUBLESHOOTING

DRIVER IDENTIFICATION – INFORMATION MESSAGES

Message	Details
Driver not found.	The user ID used is not found in database.
Wrong PIN or password	The wrong PIN or password was entered.
Driver authentication time out. Unable to establish connection to the cloud.	When logging in, the vehicle is not able to establish a connection to the cloud.
Unable to connect to cloud. Try again.	The vehicle is not able to establish a connection to the cloud.

Vehicle Software Updates

This introduces new features and provides updates to the vehicle's software systems. Make sure to switch Automatic Updates on, set a recurring update schedule and connect your vehicle to Wi-Fi. Updates could take longer when not connected to Wi-Fi or could not download at all. See **Connecting the Vehicle to a Wi-Fi Network** (page 472).

Your vehicle may be able to receive drivable software updates, non-drivable software updates or both. Drivable software updates happen during normal vehicle usage and require limited input from you. You are notified on your touchscreen and connected device prior to a non-drivable update.

Most non-drivable updates complete in less than 30 minutes, although some updates could take up to a few hours.

You are notified of vehicle software update status on to the top left of touchscreen. You can also see the notifications in your connected device. See **Software Update Indicators** (page 519).

Vehicle Software Update Requirements

Non-drivable software updates do not install if any of the following occur:

- Your vehicle is running.
- Your vehicle is switched on.
- Your vehicle is not parked.
- The 12 V battery charge is too low.
- The hazard indicators are switched on.
- The alarm is sounding.
- The doors are open.
- The parking lamps are switched on.
- You are pressing the brake pedal.
- An emergency call is in process.
- Your vehicle is in limp home mode.

Vehicle Software Update Limitations

Once you begin a non-drivable software update, you cannot:

- Cancel the update.
- Enter your vehicle unless you have a key blade.
 - You can open the doors using the mechanical latch if child locks are not on.
- Use the remote control to lock, unlock or start your vehicle.
- Drive your vehicle.
- Charge your vehicle.
 - Charging resumes once the update completes.

SOFTWARE UPDATE SETTINGS

To access the Software Updates menu:

1. Press **Settings** on the touchscreen.
2. Press **Software Updates**.

You can do the following in the Software Updates menu:

- Switch Automatic Updates on and off.
- Schedule and install software updates.
- View software update details.



Press the button next to a menu option for more information.

Switching Automatic Updates On and Off

Your vehicle may come with Automatic Updates switched on. To make sure your vehicle always has the latest software, which could include security or other enhancements, we do not recommend switching Automatic Updates off.

Vehicle Software Updates

Note: Software updates require approval to download or install with Automatic Updates switched off.

Scheduling and Installing Software Updates

Scheduling Software Updates

From the Software Updates menu:

1. Press **Schedule Updates**.
2. Select the days and time for updates.
3. Press **Save**.

The more days that updates are scheduled, the more frequently your vehicle installs new updates. We recommend selecting a time you normally do not need your vehicle, such as overnight.

Some updates require your vehicle to be switched off.

Note: The schedule you set is recurring. If Automatic Updates is on, every time a non-drivable update is available, it installs on this schedule unless you change it. You are notified on your touchscreen and connected device prior to a non-drivable update, with an option to reschedule it.

Installing Software Updates

Using the Status Bar

1. Press a Software Update indicator on your touchscreen when it appears.
2. Follow the instructions on the touchscreen.

Using the Touchscreen

From the Software Updates menu:

1. Press **Update Details**.
2. Press **Update Now**.

Viewing Software Update Details

From the Software Updates menu:

1. Press **Update Details**.

SOFTWARE UPDATE INDICATORS

You can press the indicators in the status bar when they appear for more information.



Vehicle software update reminder, schedule required, confirmation of default schedule required, or consent required.



Vehicle software update canceled, update not successful, or precondition not met.



Vehicle software update successful.

Vehicle System Reset

PERFORMING A SYSTEM RESET

Performing a system reset allows you to remove all personal information and restore settings to their factory defaults.

1. Press **Settings** on the touchscreen.
2. Press **General**.
3. Press **Reset**.
4. Press **Factory Reset**.
5. Follow the prompts on the screen to complete the reset.

Accessories

For a complete listing of the accessories that are available for your vehicle, please contact your authorized dealer or visit the online store web site:

Web Address (United States)
www.Accessories.Ford.com

Web Address (Canada)
www.Accessories.Ford.ca

We will repair or replace any properly authorized dealer-installed Ford Original Accessory found to be defective in factory-supplied materials or workmanship during the warranty period, as well as any component damaged by the defective accessories.

We will warrant your Ford Original Accessory through the warranty that provides the greatest benefit:

- 24 months, unlimited mileage.
- The remainder of your new vehicle limited warranty.

Contact an authorized dealer for details and a copy of the warranty.

Ford Licensed Accessories are the accessory manufacturer's designs. The manufacturer develops and therefore warrants Ford Licensed Accessories, and does not design or test these accessories to Ford Motor Company engineering requirements. Contact an authorized Ford dealer for the manufacturer's limited warranty details, and request a copy of the Ford Licensed Accessories product limited warranty from the accessory manufacturer.

For maximum vehicle performance, keep the following information in mind when adding accessories or equipment to your vehicle:

- When adding accessories, equipment, passengers and luggage to your vehicle, do not exceed the total weight capacity of the vehicle or of the front or rear axle (GVWR or GAWR as indicated on the Safety Compliance Certification label). Ask an authorized dealer for specific weight information.
- The Federal Communications Commission (FCC) and Canadian Radio Telecommunications Commission (CRTC) regulate the use of mobile communications systems that are equipped with radio transmitters, for example two-way radios, telephones and theft alarms. Any such equipment installed in your vehicle should comply with Federal Communications Commission (FCC) and Canadian Radio Telecommunications Commission (CRTC) regulations and should be installed only by an authorized dealer.
- An authorized dealer needs to install mobile communications systems. Improper installation may harm the operation of your vehicle, particularly if the manufacturer did not design the mobile communication system specifically for automotive use.
- If you or an authorized Ford dealer add any non-Ford electrical or electronic accessories or components to your vehicle, you may adversely affect battery performance and durability. In addition, you may also adversely affect the performance of other electrical systems in the vehicle.

Ford Protect

WHAT IS FORD PROTECT

Protect yourself from the rising cost of vehicle repairs with a Ford Protect extended service plan.

Ford Protect Extended Service Plans - United States Only

Ford Protect extended service plans mean peace of mind. Extended service plans are backed by Ford Motor Company, and provide more protection beyond the New Vehicle Limited Warranty coverage. When you visit your Ford Dealer, insist on the Ford Protect extended service plan.

Ford Protect Can Quickly Pay for Itself

One trip to the service center could easily exceed the price of your Ford Protect extended service plan. With the Ford Protect extended service plan, you minimize your risk for unexpected repair bills and rising repair costs.

Up to 1,000+ Covered Vehicle Components

There are four mechanical Ford Protect extended service plans with different levels of coverage. Ask your authorized dealer for details.

1. PremiumCARE - Our most comprehensive coverage. With over 1,000 covered components, this plan is so complete it is probably easier to list what is not covered.
2. ExtraCARE - Covers 113 components, and includes many high-tech items.
3. BaseCARE - Covers 84 components.
4. PowertrainCARE - Covers 29 critical components.

Ford Protect extended service plans are honored by all authorized Ford dealers in the United States, Canada and Mexico.

That means you get:

- Reliable, quality service at any Ford or Lincoln dealership.
- Repairs performed by factory trained technicians, using genuine parts.

Rental Car Reimbursement

First Day Rental Benefit

If you bring your car into your dealer for service, we will give you a rental vehicle to use for the day.

Extended Rental Benefits

If your vehicle is kept overnight for covered repairs, you are eligible for rental car coverage, warranty repairs, and field service actions.

Roadside Assistance

Exclusive 24/7 roadside assistance, including:

- Towing, flat-tire change and battery jump starts.
- Out of fuel and lock-out assistance.
- Travel expense reimbursement for lodging, meals and rental car.
- Assistance for taxi, shuttle, rental car coverage or other transportation.

Transferable Coverage

If you sell your vehicle before your Ford Protect extended service plan coverage expires, you can transfer any remaining coverage to the new owner. This should give you and your potential buyer peace of mind.

Ford Protect

Less Cost to Properly Maintain Your Vehicle

The Ford Protect extended service plan also offers a Premium Maintenance Plan that covers all scheduled maintenance, and selected wear items. The coverage is prepaid, so you never have to worry about the cost of your vehicle's maintenance.

Covered maintenance includes:

- Windshield wiper blades.
- Spark plugs.
- The clutch disc (if equipped).
- Brake pads and linings.
- Shock absorbers.
- Struts.
- Engine belts.
- Engine coolant hoses, clamps and o-rings.
- Diesel exhaust fluid replenishment (if equipped).
- Cabin air filter replacement every 20,000 mi (32,000 km) for electric vehicles only.

Interest Free Finance Options

Just a 5% down payment provides you with an affordable, no interest, no fee payment program allowing you all the security and benefits Ford Protect extended service plan has to offer while paying over time. You are pre-approved with no credit check or hassles. To learn more, call our Ford Protect extended service plan specialists at 800-367-3377.

Ford Protect Extended Service Plan
P.O. Box 321067
Detroit, MI 48232

Ford Protect Extended Service Plan (Canada Only)

You can get more protection for your vehicle by purchasing a Ford Protect extended service plan. Ford Protect extended service plan is the only service contract backed by Ford Motor Company of Canada, Limited. Depending on the plan you purchase, Ford Protect extended service plan provides benefits such as:

- Rental reimbursement.
- Coverage for certain maintenance and wear items.
- Protection against repair costs after your New Vehicle Limited Warranty Coverage expires.
- Roadside Assistance benefits.

There are several Ford Protect extended service plans available in various time, distance and deductible combinations. Each plan is tailored to fit your own driving needs, including reimbursement for towing and rental. When you purchase Ford Protect extended service plan, you receive added peace-of-mind protection throughout Canada, the United States and Mexico, provided by a network of participating authorized Ford Motor Company dealers.

Note: *Repairs performed outside of Canada and the United States are not eligible for Ford Protect extended service plan coverage.*

This information is subject to change. Visit your local Ford of Canada dealer or www.ford.ca to find the Ford Protect extended service plan that is right for you.

Scheduled Maintenance

GENERAL MAINTENANCE INFORMATION - GASOLINE

Why Maintain Your Vehicle?

Carefully following the maintenance schedule helps protect against major repair expenses resulting from neglect or inadequate maintenance and may help to increase the value of your vehicle when you sell or trade it. Keep all receipts for completed maintenance with your vehicle.

We have established regular maintenance intervals for your vehicle based upon rigorous testing. It is important that you have your vehicle serviced at the correct times. These intervals serve two purposes; one is to maintain the reliability of your vehicle and the second is to keep the cost of owning your vehicle down.

It is your responsibility to have all scheduled maintenance performed and to make sure that the materials used meet the specifications identified in this owner's manual. See **Capacities and Specifications** (page 452).

Failure to perform scheduled maintenance invalidates warranty coverage on parts affected by the lack of maintenance.

Why Maintain Your Vehicle at Your Dealership?

Factory-trained Technicians

Service technicians participate in extensive factory-sponsored certification training to help them become experts on the operation of your vehicle. Ask your dealership about the training and certification their technicians have received.

Genuine Ford and Motorcraft Replacement Parts

Dealerships stock Ford, Motorcraft and Ford-authorized branded re-manufactured replacement parts. These parts meet or exceed our specifications. Parts installed at your dealership carry a nationwide 12-month or 12,000 mi (20,000 km) parts and labor limited warranty.

If you do not use Ford authorized parts they may not meet our specifications and depending on the part, it could affect emissions compliance.

Convenience

Many dealerships have extended evening and Saturday hours to make your service visit more convenient and they offer one stop shopping. They can perform any services that are required on your vehicle, from general maintenance to crash repairs.

Note: *Not all dealers have extended hours or body shops. Please contact your dealer for details.*

Protecting Your Investment

Maintenance is an investment that pays dividends in the form of improved reliability, durability and resale value. To maintain the correct performance of your vehicle and its emission control systems, make sure you have scheduled maintenance performed at the designated intervals.

Your vehicle is equipped with the Intelligent Oil-Life Monitor system, which displays a message in the instrument cluster display at the correct oil change interval. This interval may be up to one year or 10,000 mi (16,000 km).

Scheduled Maintenance

Your vehicle can be driven in such a way that dilutes and increases the level of oil by short trips that do not allow the engine to get to operating temperature, extended idling, and low speed driving for long periods of time.

When the oil change message appears in the instrument cluster display, it is time for an oil change. Make sure you perform the oil change within two weeks or 500 miles (800 kilometers) of the message appearing. Make sure you reset the Intelligent Oil-Life Monitor after each oil change. See **Engine Oil Capacity and Specification** (page 457). See **Engine Oil Capacity and Specification** (page 458).

If your instrument cluster display resets prematurely or becomes inoperative, you should perform the oil change interval at six months or 5,000 mi (8,000 km) from your last oil change. Never exceed one year or 10,000 mi (16,000 km) between oil change intervals.

Your vehicle is very sophisticated and built with multiple, complex, performance systems. Every manufacturer develops these systems using different specifications and performance features. That is why it is important to rely upon your dealership to correctly diagnose and repair your vehicle.

Ford Motor Company has recommended maintenance intervals for various parts and component systems based upon engineering testing. Ford Motor Company relies upon this testing to determine the most appropriate mileage for replacement of oils and fluids to protect your vehicle at the lowest overall cost to you and recommends against maintenance schedules that deviate from the scheduled maintenance information.

We strongly recommend the use of only genuine Ford, Motorcraft or Ford-authorized re-manufactured replacement parts engineered for your vehicle.

Additives and Chemicals

This owner's manual and the Ford Workshop Manual list the recommended additives and chemicals for your vehicle. We do not recommend using chemicals or additives not approved by us as part of your vehicle's normal maintenance. Please consult your warranty information.

Oils, Fluids and Flushing

In many cases, fluid discoloration is a normal operating characteristic and, by itself, does not necessarily indicate a concern or that the fluid needs to be changed. However, a qualified expert, such as the factory-trained technicians at your dealership, should inspect discolored fluids that also show signs of overheating or foreign material contamination immediately.

Make sure to change your vehicle's oils and fluids at the specified intervals or in conjunction with a repair. Flushing is a viable way to change fluid for many vehicle sub-systems during scheduled maintenance. It is critical that systems are flushed only with new fluid that is the same as that required to fill and operate the system or using a Ford-approved flushing chemical.

Owner Checks and Services

Make sure you perform the following basic maintenance checks and inspections every month or at six-month intervals.

Scheduled Maintenance

Check every month
Engine oil level.
Function of all interior and exterior lights.
Tires (including spare) for wear and correct pressure.
Windshield washer fluid level.

Check every six months
Battery connections. Clean if necessary.
Body and door drain holes for obstructions. Clean if necessary.
Cooling system fluid level and coolant strength.
Door weatherstrips for wear. Lubricate if necessary.
Front door check arms for correct operation.
Hinges, latches and outside locks for correct operation. Lubricate if necessary.
Parking brake for correct operation.
Seatbelts and seat latches for wear and function.
Safety warning lamps (brake, ABS, airbag and seatbelt) for operation.
Washer spray and wiper operation. Clean or replace blades as necessary.

Multi-point Inspection

In order to keep your vehicle running correctly, it is important to have the systems on your vehicle checked regularly. This can help identify potential issues and prevent major problems. We recommend having the following multi-point inspection performed at every scheduled maintenance interval to help make sure your vehicle keeps running correctly.

Multi-point inspection
Accessory drive belt(s).
Battery performance.
Engine air filter.
Exhaust system.
Exterior lamps and hazard warning system operation.
Fluid levels*; fill if necessary.
For oil and fluid leaks.
Horn operation.
Radiator, cooler, heater and A/C hoses.
Suspension component for leaks or damage.
Steering and linkage.
Tires (including spare) for wear and correct pressure**.

Scheduled Maintenance

Multi-point inspection
Windshield for cracks, chips or pits.
Washer spray and wiper operation.

* Brake, coolant recovery reservoir, automatic transmission, power steering (if equipped with hydraulic power assist steering) and window washer.

**If your vehicle is equipped with a temporary mobility kit, check the tire sealant expiration Use By date on the canister. Replace as needed.

Be sure to ask your dealership service advisor or technician about the multi-point vehicle inspection. It is a comprehensive way to perform a thorough inspection of your vehicle. Your checklist gives you immediate feedback on the overall condition of your vehicle.

GENERAL MAINTENANCE INFORMATION - BATTERY ELECTRIC VEHICLE

Why Maintain Your Vehicle?

Carefully following the maintenance schedule helps protect against major repair expenses resulting from neglect or inadequate maintenance and may help to increase the value of your vehicle when you sell or trade it. Keep all receipts for completed maintenance with your vehicle.

It is important that you have your vehicle serviced at the proper times. These intervals serve two purposes; first is to maintain the reliability of your vehicle and the second is to keep the cost of owning your vehicle down.

It is your responsibility to have all scheduled maintenance performed and to make sure that the materials used meet the specifications identified in this owner's manual. See **Capacities and Specifications** (page 452).

Failure to perform scheduled maintenance and regularly inspect your vehicle may result in vehicle damage not covered by the vehicle Warranty.

Why Maintain Your Vehicle at Your Dealership?

Our Genuine Replacement Parts

Dealerships stock our parts and our authorized branded re-manufactured replacement parts. These parts meet or exceed our specifications. Parts installed at your dealership carry a nationwide 24-month or unlimited mile (kilometer) parts and labor limited warranty.

If you do not use our authorized parts, they may not meet our specifications.

Protecting Your Investment

Maintenance is an investment that pays dividends in the form of improved reliability, durability and resale value. To maintain the proper performance of your vehicle, make sure you have scheduled maintenance performed at the designated intervals.

It is important to rely upon your dealership to properly diagnose and repair your vehicle.

Scheduled Maintenance

We have recommended maintenance intervals for various parts and component systems based upon engineering testing. We rely upon this testing to determine the most appropriate mileage for replacement of fluids to protect your vehicle at the lowest overall cost to you and recommends against maintenance schedules that deviate from the scheduled maintenance information.

We strongly recommend the use of only our genuine manufactured or our authorized re-manufactured replacement parts engineered for your vehicle.

Additives and Chemicals

We do not recommend using chemicals or additives not approved by us as part of your vehicle's normal maintenance. Please consult your warranty information.

Fluids and Flushing

In many cases, fluid discoloration is a normal operating characteristic and, by itself, does not necessarily indicate a concern or that the fluid needs to be changed. However, a qualified expert, such as the factory-trained technicians at your dealership, should inspect discolored fluids that also show signs of overheating or foreign material contamination immediately.

Make sure to change your vehicle's fluids at the specified intervals or in conjunction with a repair. Flushing is a viable way to change fluid for many vehicle sub-systems during scheduled maintenance. It is critical to flush systems only with new fluid that is the same as that required to fill and operate the system or using our approved flushing chemical.

Scheduled Maintenance Service Intervals

For your scheduled maintenance service intervals, visit <https://www.ford.com/support/maintenance-schedule>.

Owner Checks and Services

Make sure you perform the following basic maintenance checks and inspections every month or at six-month intervals.

Check Every Month
Function of all interior and exterior lights.
Tires (including spare) for wear and proper pressure.
Windshield washer fluid level.

Scheduled Maintenance

Check Every Six Months
12V Battery connections. Clean if necessary.
Body and door drain holes for obstructions. Clean if necessary.
Inspect vehicle cooling systems strength and hoses.
Door weatherstrips for wear. Lubricate if necessary.
Hinges, latches and outside locks for proper operation. Lubricate if necessary.
Parking brake for proper operation.
Safety belts and seat latches for wear and function.
Safety warning lamps (brake, ABS, airbag and safety belt) for operation.
Washer spray and wiper operation. Clean or replace blades as necessary.

Multi-point Inspection

In order to keep your vehicle running right, it is important to have the systems on your vehicle checked regularly. This can help identify potential issues and prevent major problems. We recommend having the following multi-point inspection performed at every scheduled maintenance interval to help make sure your vehicle keeps running great.

Multi-Point Inspection	
12V Battery performance	Radiator, cooler, heater and air conditioning hoses
Exterior lamps and hazard warning system operation	Suspension components for leaks or damage
Fluid levels; fill if necessary ¹	Steering and linkage
For fluid leaks	Tires for wear and proper pressure ²

Scheduled Maintenance

Multi-Point Inspection	
Half-shaft dust boots	Windshield for cracks, chips or pits
Horn operation	Washer spray and wiper operation

¹ Brake, coolant recovery reservoir and window washer.

² Your vehicle has a temporary mobility kit; check the tire sealant expiration Use By date on the canister. Replace as needed.

Be sure to ask your dealership service advisor or technician about the multi-point vehicle inspection. It is a comprehensive way to perform a thorough inspection of your vehicle. Your checklist gives you immediate feedback on the overall condition of your vehicle.

NORMAL SCHEDULED MAINTENANCE - GASOLINE

Intelligent Oil-Life Monitor™

Your vehicle is equipped with an Intelligent Oil-Life Monitor that determines when you should change the engine oil based on how your vehicle is used. By using several important factors in its calculations, the monitor helps reduce the cost of owning your vehicle and reduces environmental waste at the same time.

The following table provides examples of vehicle use and its impact on oil change intervals. It is a guideline only. Actual oil change intervals depend on several factors and generally decrease with severity of use.

When to expect the oil change message	
Interval	Vehicle use and example
7,500–10,000 mi (12,000–16,000 km)	Normal - 3.5L EcoBoost
	Normal commuting with highway driving. No, or moderate, load or towing. Flat to moderately hilly roads. No extended idling.
7,500–15,000 mi (12,000–24,000 km)	Normal - 3.5L Duratec
	Normal commuting with highway driving. No, or moderate, load or towing. Flat to moderately hilly roads. No extended idling.

Scheduled Maintenance

When to expect the oil change message	
Interval	Vehicle use and example
5,000–7,500 mi (8,000–12,000 km)	Severe
	Moderate to heavy load or towing. Mountainous or off-road conditions. Extended idling. Extended hot or cold operation.
3,000–5,000 mi (4,800–8,000 km)	Extreme
	Maximum load or towing. Extreme hot or cold operation.

Normal Maintenance Intervals

At every oil change interval as indicated by the information display ¹
Change engine oil and filter.**
Rotate tires, inspect tire wear and measure tread depth.
Perform a multi-point inspection (recommended).
Inspect the automatic transmission fluid level (if equipped with dipstick). Consult your dealer for requirements.
Inspect the brake pads, shoes, rotors, drums, brake linings, hoses and parking brake.
Inspect the engine cooling system strength and hoses.
Inspect the exhaust system and heat shields.
Inspect front axle and U-joints. Lubricate if equipped with grease fittings.
Inspect the steering linkage, ball joints, suspension, tire-rod ends, driveshaft and U-joints. Lubricate any areas with grease fittings.
Inspect the wheels and related components for abnormal noise, wear, looseness or drag.

¹ Do not exceed one year or 10,000 mi (16,000 km) between service intervals for 3.5L EcoBoost, or one year or 15,000 mi (24,000 km) between service intervals for 3.5L Duratec.

** Reset the Intelligent Oil-Life Monitor after engine oil and filter changes.

Scheduled Maintenance

Brake fluid maintenance¹	
Every 3 years	Change the brake fluid. ²

¹ Perform this maintenance item every 3 years. Do not exceed the designated time for the interval.

² Brake fluid servicing requires special equipment available at your authorized dealer.

Other maintenance items¹	
Every 20,000 mi (32,000 km)	Replace cabin air filter.
Every 30,000 mi (48,000 km)	Torque rear axle U-bolts to specification.
	Replace engine air filter.
At 200,000 mi (320,000 km)	Change engine coolant. ²
Every 100,000 mi (160,000 km)	Replace spark plugs.
	Inspect accessory drive belt(s). ³
Every 150,000 mi (240,000 km)	Change automatic transmission fluid and filter.
	Change front axle fluid.
	Change rear axle fluid.
	Change the transfer case fluid. ⁴
	Replace accessory drive belt(s).

¹ Perform these maintenance items within 3,000 mi (4,800 km) of the last engine oil and filter change. Do not exceed the designated distance for the interval.

² Initial replacement at ten years or 200,000 mi (320,000 km), then every five years or 100,000 mi (160,000 km).

³ After initial inspection, inspect every other oil change until replaced.

⁴ Four-wheel drive only.

Scheduled Maintenance

NORMAL SCHEDULED MAINTENANCE - BATTERY ELECTRIC VEHICLE

Normal Scheduled Maintenance ¹	
Every 12 months or 10,000 mi (16,000 km).	Rotate tires, inspect tire wear and measure tread depth.
	Perform multi-point inspection (recommended).
	Inspect brake pads, shoes, rotors, drums, brake linings, hoses and parking brake.
	Inspect the cooling system coolant level and coolant strength.
	Inspect half-shaft boots.
	Inspect steering linkage, ball joints, suspension and tie-rod ends.
	Inspect wheels and related components for abnormal noise, wear, looseness or drag.

¹ Do not exceed one year or 10,000 mi (16,000 km) between service intervals.

Brake Fluid Maintenance ¹	
Every 3 Years	Change brake fluid. ²

¹ Perform this maintenance item every 3 years. Do not exceed the designated time for the interval.

² Brake fluid servicing requires special equipment available at your authorized dealer.

Scheduled Maintenance

Other Maintenance Items	
Every 20,000 mi (32,000 km)	Replace cabin air filter. ¹
At 10 years or 150,000 mi (240,000 km)	Replace electric drive assembly fluid.
At 200,000 mi (322,000 km)	Change yellow coolant. ²

¹Cabin air filter life is dependent on exposure to dusty and dirty conditions. Vehicles operated in these conditions require frequent inspection and replacement of the cabin air filter.

²Initial replacement at 10 years or 200,000 mi (322,000 km), then every 5 years or 100,000 mi (160,000 km).

Scheduled Maintenance

SPECIAL OPERATING CONDITIONS SCHEDULED MAINTENANCE

If you operate your vehicle **primarily** in any of the following conditions, you need to perform extra maintenance as indicated. If you operate your vehicle **occasionally** under any of these conditions, it is not necessary to perform the extra maintenance. For specific recommendations, see your dealership service advisor or technician.

Perform the services shown in the following tables when specified or within 3000 miles (4800 kilometers) of the oil change required message appearing in the instrument cluster display.

- **Example 1:** The message appears at 28,750 mi (46,270 km). Perform the 30,000 mi (48,000 km) automatic transmission fluid replacement.
- **Example 2:** The message does not appear, but the odometer reads 30,000 mi (48,000 km) (for example, the Intelligent Oil-Life Monitor was reset at 25,000 mi (40,000 km)). Perform the engine air filter replacement.

Towing a trailer or using a car-top carrier	
As required	Change engine oil and filter as indicated by the instrument cluster display and perform services listed in the Normal Scheduled Maintenance chart.
Inspect frequently, service as required	Inspect and lubricate U-joints.
	See axle maintenance items under Exceptions .
Every 60000 miles (96000 km)	Replace spark plugs.

Extensive Idling or Low-speed Driving for Long Distances, as in Heavy Commercial Use (Such as Delivery, Taxi, Patrol Car or Livery) Short Trips that do not allow the engine to get to operating temperature causing fuel dilution and an increase of the engine oil level	
As required	Change engine oil and filter as indicated by the instrument cluster display and perform services listed in the Normal Scheduled Maintenance chart.
Inspect frequently, service as required	Replace engine air filter.
Every 60000 miles (96000 km)	Replace spark plugs.

Scheduled Maintenance

Operating in dusty or sandy conditions (such as unpaved or dusty roads)	
Inspect frequently, service as required	Replace engine air filter.
Every 5000 miles (8000 km)	Inspect the wheels and related components for abnormal noise, wear, looseness or drag.
	Rotate tires, inspect tires for wear and measure tread depth.
Every 5000 miles (8000 km) or six months	Change engine oil and filter.*

*Reset your Intelligent Oil-Life Monitor after each engine oil and filter change.

Off-road operation	
Inspect frequently, service as required	Inspect steering linkage, ball joints and U-joints. Lubricate if equipped with grease fittings.
	Replace engine air filter.
Every 5000 miles (8000 km) or six months	Change engine oil and filter.*
	Inspect the wheels and related components for abnormal noise, wear, looseness or drag.
	Rotate tires, inspect tires for wear and measure tread depth.

*Reset your Intelligent Oil-Life Monitor after each engine oil and filter change.

Exclusive use of E85 (Flex fuel vehicles only)	
Every oil change interval	If ran exclusively on E85, fill the fuel tank full with regular unleaded fuel.

Exceptions

There are several exceptions to the Normal Schedule:

Axle and Transfer Case Maintenance

Axle(s) and transfer case (Four-wheel drive vehicles) fluid changes or level checks are not required unless a leak is suspected or the assembly has been submerged in water. Contact an authorized dealer for service.

Scheduled Maintenance

California fuel filter replacement

If you register your vehicle in California, the California Air Resources Board has determined that the failure to perform this maintenance item does not nullify the emission warranty or limit recall liability before the completion of your vehicle's useful life. Ford Motor Company, however, urges you to have all recommended maintenance services performed at the specified intervals and to record all vehicle service.

Hot climate oil change intervals

Vehicles operating in the Middle East, North Africa, Sub-Saharan Africa or locations with similar climates using an American Petroleum Institute (API) Certified for Gasoline Engines (Certification mark) oil of SM or SN quality, the normal oil change interval is 5,000 mi (8,000 km).

If the available API SM or SN oils are not available, then the oil change interval is 3,000 mi (4,800 km).

Engine air filter replacement

The life of the engine air filter is dependent on exposure to dusty and dirty conditions. Vehicles operated in these conditions require frequent inspection and replacement of the engine air filter.

Customer Information

ROLLOVER WARNING



WARNING: Utility vehicles have a significantly higher rollover rate than other types of vehicles.



WARNING: Vehicles with a higher center of gravity (utility and four-wheel drive vehicles) handle differently than vehicles with a lower center of gravity (passenger cars). Avoid sharp turns, excessive speed and abrupt steering in these vehicles. Failure to drive cautiously increases the risk of losing control of your vehicle, vehicle rollover, personal injury and death.



WARNING: In a rollover crash, an unbelted person is significantly more likely to die than a person wearing a seatbelt.



WARNING: Do not become overconfident in the ability of four-wheel drive vehicles. Although a four-wheel drive vehicle may accelerate better than a two-wheel drive vehicle in low traction situations, it won't stop any faster than two-wheel drive vehicles. Always drive at a safe speed.

Utility vehicles and trucks handle differently than passenger cars in the various driving conditions that are encountered on streets, highways and off-road. Utility vehicles and trucks are not designed for cornering at speeds as high as passenger cars any more than low-slung sports cars are designed to perform satisfactorily under off-road conditions.

THE BETTER BUSINESS BUREAU AUTO LINE PROGRAM

Your satisfaction is important to Ford Motor Company and to your dealer. If a warranty concern has not been resolved using the three-step procedure outlined earlier in this chapter in the Getting the Services you need section, you may be eligible to participate in the BBB AUTO LINE program.

The BBB AUTO LINE program consists of two parts – mediation and arbitration. During mediation, a representative of the BBB will contact both you and Ford Motor Company to explore options for settlement of the claim. If an agreement is not reached during mediation or you do not want to participate in mediation, and if your claim is eligible, you may participate in the arbitration process. An arbitration hearing will be scheduled so that you can present your case in an informal setting before an impartial person. The arbitrator considers the testimony provided and makes a decision after the hearing.

Disputes submitted to the BBB AUTO LINE program are usually decided within 40 days after you file your claim with the BBB. You are not bound by the decision, and may reject the decision and proceed to court where all findings of the BBB Auto Line dispute, and decision, are admissible in the court action. Should you choose to accept the BBB AUTO LINE decision, Ford is then bound by the decision, and must comply with the decision within 30 days of receipt of your acceptance letter.

BBB AUTO LINE Application: Using the information that follows, call or write to request a program application. You will be asked for your name and address, general information about your new vehicle, information about your warranty concerns, and any steps you have already taken to

Customer Information

try to resolve them. A Customer Claim Form will be mailed that needs to be completed, signed and returned to the BBB along with proof of ownership. Upon receipt, the BBB reviews the claim for eligibility under the Program Summary Guidelines.

You can get more information by calling BBB AUTO LINE at 1-800-955-5100, or writing to:

**BBB AUTO LINE a Division of BBB National Programs, Inc.
1676 International Drive, Suite 550
McLean, VA 22102**

BBB AUTO LINE applications can also be requested by calling the Ford Motor Company Customer Relationship Center at 1-800-392-3673.

For additional information, refer to the Better Business Bureau website.

Note: *Ford Motor Company reserves the right to change eligibility limitations, modify procedures, or to discontinue this process at any time without notice and without obligation.*

THE MEDIATION AND ARBITRATION PROGRAM

For vehicles delivered to authorized Canadian dealers. In those cases where you continue to feel that the efforts by Ford of Canada and the authorized dealer to resolve a factory-related vehicle service concern have been unsatisfactory, Ford of Canada participates in an impartial third party mediation/arbitration program administered by the Canadian Motor Vehicle Arbitration Plan (CAMVAP).

The CAMVAP program is a straightforward and relatively speedy alternative to resolve a disagreement when all other efforts to produce a settlement have failed. This procedure is without cost to you and is designed to eliminate the need for lengthy and expensive legal proceedings.

In the CAMVAP program, impartial third-party arbitrators conduct hearings at mutually convenient times and places in an informal environment. These impartial arbitrators review the positions of the parties, make decisions and, when appropriate, render awards to resolve disputes. CAMVAP decisions are fast, fair, and final as the arbitrator's award is binding on both you and Ford of Canada.

CAMVAP services are available in all Canadian territories and provinces. For more information, without charge or obligation, call your CAMVAP Provincial Administrator directly at 1-800-207-0685 or visit www.camvap.ca.

ORDERING A CANADIAN FRENCH OWNER'S MANUAL

You can obtain a French owner's manual from an authorized dealer or by contacting Helm, LLC at:

HELM, LLC
47911 Halyard Drive, Suite 200
Plymouth, Michigan 48170
Attention: Customer Service

Call toll free: 1-800-782-4356

Monday-Friday 8:00 a.m. - 6:00 p.m. EST

For additional information, visit www.helminc.com.

Customer Information

REPORTING SAFETY DEFECTS IN THE UNITED STATES

If you believe that your vehicle has a defect which could cause a crash or could cause injury or death, you should immediately inform the National Highway Traffic Safety Administration (NHTSA) in addition to notifying Ford Motor Company.

If NHTSA receives similar complaints, it may open an investigation, and if it finds that a safety defect exists in a group of vehicles, it may order a recall and remedy campaign. However, NHTSA cannot become involved in individual problems between you, your dealer, or Ford Motor Company.

To contact NHTSA, you may call the Vehicle Safety Hotline toll-free at 1-888-327-4236 (TTY: 1-800-424-9153); go to www.safercar.gov; or write to:

Administrator

1200 New Jersey Avenue,
Southeast

Washington, D.C. 20590

You can also obtain other information about motor vehicle safety from www.safercar.gov.

REPORTING SAFETY DEFECTS IN CANADA

If you believe that your vehicle has a defect which could cause a crash or could cause injury or death, you should immediately inform Transport Canada and Ford of Canada.

Transport Canada Contact Information

Website (English)	http://tc.canada.ca/recalls
Website (French)	http://tc.canada.ca/rappels
Phone	1-800-333-0510

Ford of Canada Contact Information

Website	www.ford.ca
Phone	1-800-565-3673

Customer Information

THIRD PARTY SOFTWARE COPYRIGHT ACKNOWLEDGMENT

Your vehicle could have components that use open source software. For additional information, visit [http://
corporate.ford.com/ford-open-source.html](http://corporate.ford.com/ford-open-source.html).

Ghana

NCA APPROVED: 7E5-7M-XC6-RDR

RADIO FREQUENCY CERTIFICATION LABELS

AUDIO UNIT

Armenia

NCA APPROVED: 7E5-7M-XC7-RDR



Serbia

European Union EU

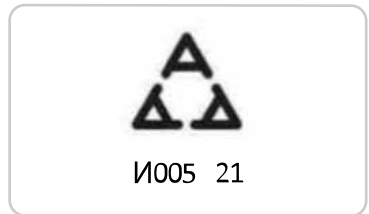
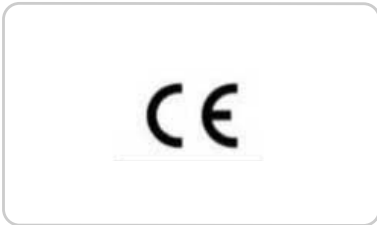

Customer Information

South Africa



South Korea



R-R-VC1-AHUA001

R-R-VC1-AHUB001

United Kingdom



United States

This device complies with part 15 of the FCC Rules. Operation is subject to the condition that this device does not cause harmful interference.

BLIND SPOT INFORMATION SYSTEM SENSORS

Device	Supplier	Type Designation
Short Range Radar (SRR)	Continental	SRR3-B

Customer Information

Argentina



RAMATEL
C-17954

Belarus



Brazil



Canada

Short Range Radar Sensor SRR3-B
IC ID: 4135A-SRR3B

Customer Information

This device contains licence-exempt transmitter(s)/receiver(s) that comply with Innovation, Science and Economic Development Canada's licence-exempt RSS(s). Operation is subject to the following two conditions:

1. This device may not cause interference.
2. This device must accept any interference, including interference that may cause undesired operation of the device.

Radiofrequency radiation exposure information:

This equipment complies with radiation exposure limits set forth for an uncontrolled environment. This equipment should be installed and operated with minimum distance of 8 in (20 cm) between the radiator and the body of any persons, user or bystander.

L'émetteur/récepteur exempt de licence contenu dans le présent appareil est conforme aux CNR d'Innovation, Sciences et Développement économique Canada applicables aux appareils radio exempts de licence. L'exploitation est autorisée aux deux conditions suivantes:

1. L'appareil ne doit pas produire de brouillage;
2. L'appareil doit accepter tout brouillage radioélectrique subi, même si le brouillage est susceptible d'en compromettre le fonctionnement.

Cet équipement est conforme aux limites d'exposition aux rayonnements établies pour un environnement non contrôlé. Cet équipement doit être installé et utilisé avec un minimum de 8 in (20 cm) de distance entre la source de rayonnement et votre corps.

Djibouti

AGREE PAR LE MCPT (REPUBLIQUE DE DJIBOUTI)
Numéro d'agrément : 240/MCPT/SG/16
Date d'agrément : 23/05/2016

European Union EU

CE

Customer Information

Ghana

NCA PRODUCT IDENTIFIER: 3R8-8M-7DF-231

Malaysia



Israel

HIDF16000009

Mauritania

1. מספר אישור התאמה מסוג משרד התקשורת 51-63484
2. תח איתור לבצע פעולות בבכשור שישו בהן כדי לשנות את תכונותיו האלקטרוניות של המכשיר, ובכלל זה שינוי תוכנה, החלפת אנטנה מקורית או הוספת אפשרות לחיבור לאנטנה חיצונית, בלא קבלת אישור משרד התקשורת, בשל החשש להפרעת אלקטרונית.

AGREE PAR L'ANE MAURITANIE
Numéro d'agrément : 0727/ARE/2018
Date d'agrément : 10/12/2019

Jamaica

This product has been Type Approved
by Jamaica: SMA - SRR3-B.

Mexico

IFETEL: RLVCSR15-0904

La operación de este equipo está sujeta a las siguientes
dos condiciones:

- (1) es posible que este equipo o dispositivo no cause interferencia perjudicial y
- (2) este equipo o dispositivo debe aceptar cualquier interferencia, incluyendo la que pueda causar su operación no deseada.

Customer Information

Moldova



Russia



Serbia



N011 18

Pakistan



Singapore

Paraguay



Complies with IMDA Standards

DA 00461

Customer Information

South Africa



South Korea



MSIP-CRM-8DC-SRR3B

Taiwan

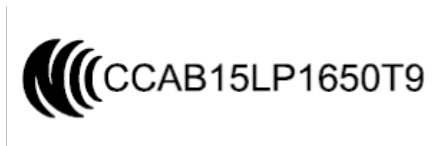

警語

經型式認證合格之低功率射頻電機，非經許可，公司、商號或使用者均不得擅自變更頻率、加大功率或變更原設計之特性及功能。

低功率射頻電機之使用不得影響飛航安全及干擾合法通信；經發現有干擾現象時，應立即停用，並改善至無干擾時方得繼續使用。

前項合法通信，指依電信法規定作業之無線電通信。低功率射頻電機須忍受合法通信或工業、科學及醫療用電波輻射性電機設備之干擾。

Customer Information

Ukraine



справжнім FDC. Automotive Distance Control Systems GmbH заявляє, що тип радіообладнання SRR3 - В відповідає технічному регламенту радіообладнання ;

повний текст декларації про відповідність доступний на веб-сайті за такою адресою :

<http://continental.automotive-approvals.com/>

United Arab Emirates (U.A.E.)

TRA
REGISTERED No:
ER62934

DEALER No:
DA40068

United Kingdom



United States of America

FCC ID: OAYSRR3B

This device complies with Part 15 of the FCC Rules. Operation is subject to the following two conditions:

1. This device may not cause harmful interference, and
2. This device must accept any interference received, including interference that may cause undesired operation.

CAUTION TO USERS

Customer Information

Changes or modifications not expressly approved by the party responsible for compliance could void the user's authority to operate the equipment.

Vietnam



Zambia



BODY CONTROL MODULE

Argentina



Brazil



Ghana

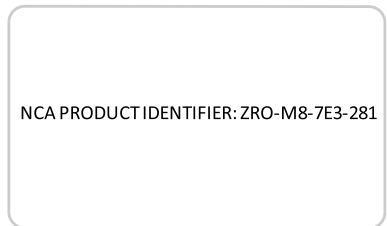

Customer Information

Jamaica

This product has been Type Approved by Jamaica: SMA - M3NA2C766336.

Paraguay



2019-01-I-000076

Moldova



Serbia



Morocco

AGREE PAR L'ANRT MAROC
Numéro d'agrément: MR 20148 ANRT 2019
Date d'agrément: 19/06/2019

Singapore

Complies with IMDA Standards

DA 00461

Customer Information

South Africa



Ukraine



United Arab Emirates (U.A.E.)

TRA REGISTERED No: ER68566/19

DEALER No: DA37380/15

United Kingdom



United States and Canada

 **WARNING:** Changes or modifications not expressly approved by the party responsible for compliance could void the user's authority to operate the equipment. The term "IC:" before the radio certification number only signifies that Industry Canada technical specifications were met.

FCC ID: M3NA2C766336

IC: 7812A-A2C766336

This device complies with Part 15 of the FCC Rules and with Innovation, Science and Economic Development Canada's licence-exempt RSS(s). Operation is subject to the following two conditions:

1. This device may not cause harmful interference, and
2. This device must accept any interference received, including interference that may cause undesired operation.

Vietnam



Customer Information

Zambia



CRUISE CONTROL MODULE

Device	Supplier	Type Designation
Mid Range Radar (MRR)	Delphi/Aptiv	L2C0065TR

Argentina



Brazil



Djibouti

AGREE PAR LE MCPT (REPUBLIQUE DE DJIBOUTI)
Numéro d'agrément : 594/dpt/2017
Date d'agrément : 09/04/2017

European Union EU

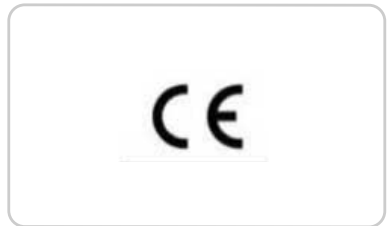

Customer Information

Ghana

NCA PRODUCT IDENTIFIER: OR2-9H-7E1-x4D

Malaysia



Indonesia

SERTIFIKAT NOMOR : 53104/SDPPI/2017
PLG ID: 4927



HIDF16000009

Mauritania

AGREE PAR L'ANE MAURITANIE
Numéro d'agrément: 0409/ARE/2017
Date d'agrément: 12/04/2017

Israel

1. מספר אישור התאמה מסעם משרד התקשורת: 51-63483
2. חל אישור לבצע פעולות כמספר שיש בהן כדי לשנות את תכונותיו האלחוטיות של המכשיר, ובכלל זה שינוי תוכנה, החלפת אנטנה סקורת או חוספת אפשרות לחיבור לאנטנה חיצונית, בלא קבלת אישור משרד התקשורת, ככל החשש להפרעת אלחוטיות.

Moldova



Jamaica

This product has been Type Approved
by Jamaica: SMA - L2C0065TR.

Customer Information

Morocco

AGREE PAR L'ANRT MAROC
Numéro d'agrément: MR 13639 ARNT 2017
Date d'agrément: 28/03/2017

Serbia



Pakistan



Singapore

Complies with IMDA Standards
DA105753

Paraguay



South Africa



Customer Information

South Korea



R-CMM-DLH-L2C0065TR

Syria

SyTRA
REGISTERED No:
FR00085-17

Taiwan, China

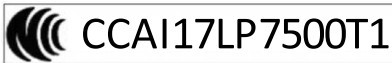

Ukraine



United Arab Emirates



United Kingdom



Customer Information

United States and Canada



WARNING: Changes or modifications not expressly approved by the party responsible for compliance could void the user's authority to operate the equipment. The term "IC:" before the radio certification number only signifies that Industry Canada technical specifications were met.

FCC ID: L2C0065TR

IC: 3432A-0065TR

This device complies with Part 15 of the FCC Rules and with Innovation, Science and Economic Development Canada's licence-exempt RSS(s). Operation is subject to the following two conditions:

1. This device may not cause harmful interference, and
2. This device must accept any interference received, including interference that may cause undesired operation.

Zambia



KEYS AND REMOTE CONTROLS

Argentina

CNC: H-16366



CNC: H-24101



Brazil



Customer Information



Paraguay



European Union EU

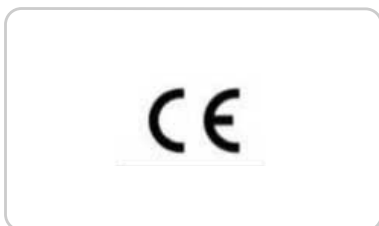

NR: 2017-10-I-0000334

NR: 2018-07-I-000317

NR: 2016-9-I-000220

NR: 2016-9-I-000223

Pakistan

Pakistan Telecommunication Authority



Approved by PTA 2016

Jamaica

This product has been Type Approved by Jamaica: SMA – M3N-A2C931423

Customer Information

United Arab Emirates (U.A.E.)



TRA
REGISTERED No:
ER37535/15

DEALER No:
DA37380/15

Taiwan

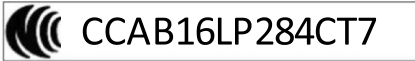

TRA
REGISTERED NO: ER49357/16
DEALER NO: DA37380/15



TRA
REGISTERED No: ER47690/16
DEALER No: DA37380/15

Customer Information

TRA
REGISTERED NO: ER46754/16
DEALER NO: DA37380/15

IC: 7812A-A3C054339

IC: 3248A-A08TAA

IC: 7812A-A2C931423

IC: 7812A-A2C931426

This device complies with Part 15 of the FCC Rules and with Innovation, Science and Economic Development Canada's licence-exempt RSS(s). Operation is subject to the following two conditions:

1. This device may not cause harmful interference, and
2. This device must accept any interference received, including interference that may cause undesired operation.

United Kingdom



United States and Canada



WARNING: Changes or modifications not expressly approved by the party responsible for compliance could void the user's authority to operate the equipment. The term "IC:" before the radio certification number only signifies that Industry Canada technical specifications were met.

FCC ID: M3N-A3C054338

FCC ID: M3N-A3C054339

FCC ID: N5F-A08TAA

FCC ID: N5F-A08TDA

FCC ID: M3N-A2C931423

FCC ID: M3N-A2C931426

IC: 7812A-A3C054338

PASSIVE ANTI-THEFT SYSTEM

Argentina

CNC: H-20727

CNC COMISIÓN NACIONAL
DE COMUNICACIONES

Customer Information

Brazil



0106-14-03199

Este equipamento opera em caráter secundário, isto é, não tem direito a proteção contra interferência prejudicial, mesmo de estações do mesmo tipo, e não pode causar interferência a sistemas operando em caráter primário.

Canada and United States of America



WARNING: Changes or modifications not expressly approved by the party responsible for compliance could void the user's authority to operate the equipment. The term "IC:" before the radio certification number only signifies that Industry Canada technical specifications were met.

FCC ID: OUC11545917

IC: OUC11545917

This device complies with Part 15 of the FCC Rules and with Innovation, Science and Economic Development Canada's licence-exempt RSS(s). Operation is subject to the following two conditions:

1. This device may not cause harmful interference, and
2. This device must accept any interference received, including interference that may cause undesired operation.

Djibouti

AGREE PAR LE MCPT (REPUBLIQUE DE DJIBOUTI)
Numéro d'agrément: 243/MCPT/SC/16
Date d'agrément: 23/05/16

Ghana

NCA APPROVED: NCA/TA/16/22

Indonesia

SERTIFIKAT NOMOR : 44714/SDPPI/2016
PLG ID: 4941

Customer Information

Jamaica

This product has been Type Approved by Jamaica: SMA- OUC11545917

Moldova



Malaysia



Morocco

AGREE PAR L'ANRT MAROC
Numéro d'agrément: MR 8922 ANRT 2014
Date d'agrément: 04/02/2014

CIDF18000209

Mauritania

AGREE PAR L'ANE MAURITANIE
Numéro d'agrément: 0231/ARE/2014
Date d'agrément: 14/11/2014

Pakistan



Customer Information

Paraguay

NR: 2017-09-10000292



South Africa

TA-2013/1617

APPROVED



Serbia



И011 16

South Korea



MSIP-RRM-OAC-OUC11541917

Singapore

Complies with IMDA Standards

DA 00461

Syria

SyTRA
REGISTERED No:
1510/4NK

Customer Information

Taiwan

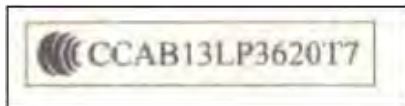

Vietnam



Ukraine



RADIO TRANSCEIVER MODULE

Argentina



United Arab Emirates (U.A.E.)

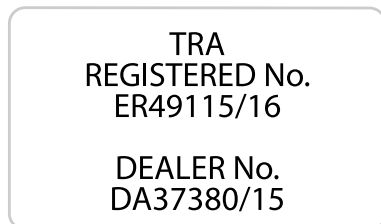

Brazil



Customer Information

Djibouti

AGREE PAR LE MCPT (REPUBLIQUE DE DJIBOUTI)
Numéros d'agrément : 033/DDTIC/2020
Date d'agrément : 07/06/2020

AGREE PAR LE MCPT (REPUBLIQUE DE DJIBOUTI)
Numéros d'agrément : 034/DDTIC/2020
Date d'agrément : 07/06/2020

AGREE PAR L'ANE MAURITANIE
Numéro d'agrément : 0802/ARE/2020
Date d'agrément : 03/06/2020

Ghana

NCA APPROVED: SRO-1M-7E4-108

NCA APPROVED: SRO-1M-7E4-114

Morocco

AGREE PAR L'ANE MAROC
Numéro d'agrément : MR 24102 ANRT 2020
Date d'agrément : 18/05/2020

Mauritania

AGREE PAR L'ANE MAURITANIE
Numéro d'agrément: 0803/ARE/2020
Date d'agrément: 03/06/2020

Pakistan



Customer Information

South Africa



United Arab Emirates (U.A.E.)

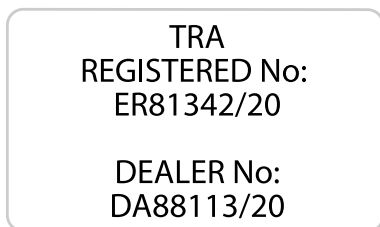
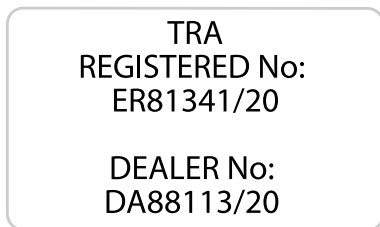

United States and Canada

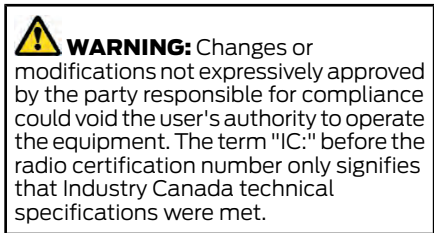

FCC ID: L2C0082R

FCC ID: L2C0083TR

FCC ID: L2C0086R

IC: 342A-0083TR

IC: CAN RSS-Gen/CNR-Gen

This device complies with Part 15 of the FCC Rules and with Innovation, Science and Economic Development Canada's licence-exempt RSS(s). Operation is subject to the following two conditions:

1. This device may not cause harmful interference, and
2. This device must accept any interference received, including interference that may cause undesired operation.

Zambia



Customer Information

SYNC

Device	Supplier	Type Designation
SYNC	Ford	SYNC-G4 SYNC-G4L

Argentina



Brazil



08657-19-01505

Este equipamento não tem direito à proteção
contra interferência prejudicial e não pode causar
interferência em sistemas devidamente autorizados.



08658-19-01505

Este equipamento não tem direito à proteção
contra interferência prejudicial e não pode causar
interferência em sistemas devidamente autorizados.

Djibouti

AGREE PAR LE MCPT (REPUBLIQUE DE DJIBOUTI)

Numéro d'agrément : 124/DDTIC/2019

Date d'agrément : 07/08/2019

Customer Information

AGREE PAR LE MCPT (REPUBLIQUE DE DJIBOUTI)
Numéro d'agrément : 125/DDTIC/2019
Date d'agrément : 07/08/2019

Indonesia

Model: SYNC-G4
Sertifikat Nomor: 80700/SDPPI/2022
PLG ID: 13493



European Union EU

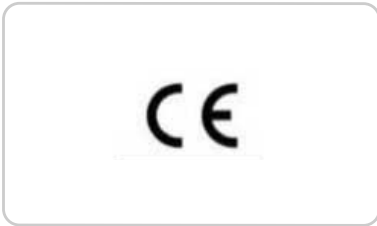

Model: SYNC-G4L
Sertifikat Nomor: **81116**/SDPPI/2022
PLG ID: 13493



Ghana

NCA APPROVED: ZRO-1H-7E3-182

NCA APPROVED: ZRO-1H-7E3-180

Jamaica

This product has been Type Approved by
Jamaica: SMA – SYNC-G4.

Customer Information

This product has been Type Approved by Jamaica: SMA – SYNC-G4L

AGREE PAR L'ANE MAURITANIE
Numéro d'agrément : 0691/ARE/2018
Date d'agrément : 08/08/2019

Malaysia



Moldova



HIDF16000009

Mauritania

AGREE PAR L'ANE MAURITANIE
Numéro d'agrément : 0692/ARE/2018
Date d'agrément : 08/08/2019

Morocco

AGREE PAR L'ANRT MAROC
N° D'AGRÉMENT: MR 20608 ANRT 2019
07 AOUT 2019

Customer Information

Serbia

AGREE PAR L'ANRT MAROC
N° D'AGRÉMENT: MR 20606 ANRT 2019
07 AOUT 2019



И005 20

Pakistan



Singapore

Complies with IMDA Standards

DA 00461

Paraguay



South Africa



2020-03-I-00192

2020-03-I-00193

Customer Information

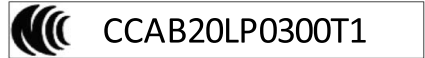

South Korea



Ukraine



Taiwan



Customer Information

United Arab Emirates (U.A.E.)

TDR 

ER74903/19
United Arab Emirates



TDR 

ER74902/19
United Arab Emirates



United Kingdom

**UK
CA**

United States and Canada

 **WARNING:** Changes or modifications not expressly approved by the party responsible for compliance could void the user's authority to operate the equipment. The term "IC:" before the radio certification number only signifies that Industry Canada technical specifications were met.

FCC ID: KMH-SYNCG4

FCC ID: KMH-SYNCG4L

IC: 1422A-SYNCG4

IC: 1422A-SYNCG4L

Customer Information

This device complies with Part 15 of the FCC Rules and with Innovation, Science and Economic Development Canada's licence-exempt RSS(s). Operation is subject to the following two conditions:

1. This device may not cause harmful interference, and
2. This device must accept any interference received, including interference that may cause undesired operation.



Zambia



TELEMATICS CONTROL UNIT

Device	Supplier	Type Designation
Telematics Control Unit	Ford	FB5-TCU

Customer Information

Argentina



C-28150

Brazil



Europe Union EU

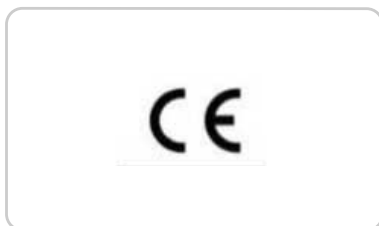

Malaysia



HIDF16000009

Mexico



Customer Information

South Africa



Taiwan



We recommend that the distance between the antenna of the telematics control unit and the user be greater than 14 in (35 cm) when using the telematics control unit.

United Arab Emirates (U.A.E.)



United Kingdom



United States and Canada

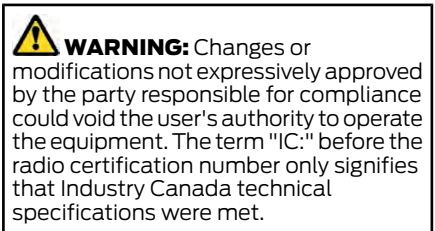

FCC ID: KMH-14H074-NA1

IC: 1422A-14H074NA1

Customer Information

This device complies with Part 15 of the FCC Rules and with Innovation, Science and Economic Development Canada's licence-exempt RSS(s). Operation is subject to the following two conditions:

1. This device may not cause harmful interference, and
2. This device must accept any interference received, including interference that may cause undesired operation.

Vietnam



Mexico

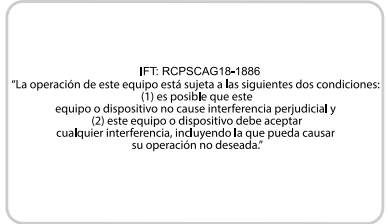

Taiwan



TIRE PRESSURE MONITORING SYSTEM SENSORS

Brazil



United States and Canada

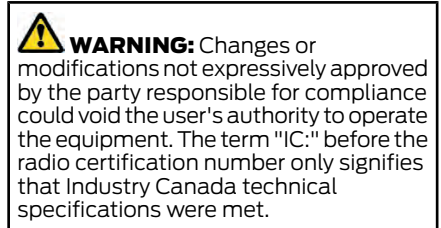

FCC ID: MRXAG2SM3

IC: 2546A-AG2SM3

Customer Information

This device complies with Part 15 of the FCC Rules and with Innovation, Science and Economic Development Canada's licence-exempt RSS(s). Operation is subject to the following two conditions:

1. This device may not cause harmful interference, and
2. This device must accept any interference received, including interference that may cause undesired operation.

PERCHLORATE

Certain components in your vehicle such as airbag modules, seatbelt pretensioners and remote control batteries may contain perchlorate material. Special handling may apply for service or vehicle end of life disposal.

For more information visit:
www.dtsc.ca.gov/hazardouswaste/perchlorate.

REPLACEMENT PARTS RECOMMENDATION

We have built your vehicle to the highest standards using quality parts. We recommend that you demand the use of genuine Ford and Motorcraft parts whenever your vehicle requires scheduled maintenance or repair. You can clearly identify genuine Ford and Motorcraft parts by looking for the Ford, FoMoCo or Motorcraft branding on the parts or their packaging.

Scheduled Maintenance and Mechanical Repairs

One of the best ways for you to make sure that your vehicle provides years of service is to have it maintained in line with our recommendations using parts that conform to the specifications detailed in this Owner's Manual.

Genuine Ford and Motorcraft parts meet or exceed these specifications.

Collision Repairs

We hope that you never experience a collision, but accidents happen sometimes.

Genuine Ford replacement collision parts meet our stringent requirements for fit, finish, structural integrity, corrosion protection and dent resistance. During vehicle development we validate that these parts deliver the intended level of protection as a whole system. A great way to know for sure you are getting this level of protection is to use genuine Ford replacement collision parts.

Warranty on Replacement Parts

Genuine Ford and Motorcraft replacement parts are the only replacement parts that benefit from a Ford Warranty.

The Ford Warranty may not cover damage caused to your vehicle as a result of failed non-Ford parts.

For additional information, refer to the terms and conditions of the Ford Warranty.

MOBILE COMMUNICATIONS EQUIPMENT



WARNING: Driving while distracted can result in loss of vehicle control, crash and injury. We strongly recommend that you use extreme caution when using any device that may take your focus off the road. Your primary responsibility is the safe operation of your vehicle. We recommend against the use of any

Customer Information

hand-held device while driving and encourage the use of voice-operated systems when possible. Make sure you are aware of all applicable local laws that may affect the use of electronic devices while driving.

Using mobile communications equipment is becoming increasingly important in the conduct of business and personal affairs. However, you must not compromise your own or others' safety when using such equipment. Mobile communications can enhance personal safety and security when appropriately used, particularly in emergency situations. Safety must be paramount when using mobile communications equipment to avoid negating these benefits. Mobile communication equipment includes, but is not limited to, cellular phones, pagers, portable email devices, text messaging devices and portable two-way radios.

END USER LICENSE AGREEMENT

VEHICLE SOFTWARE END USER LICENSE AGREEMENT (EULA)

- You ("You" or "Your" as applicable) have acquired a vehicle having several devices, including SYNC ® and various control modules, ("DEVICES") that include software licensed or owned by Ford Motor Company and its affiliates ("FORD MOTOR COMPANY"). Those software products of FORD MOTOR COMPANY origin, as well as associated media, printed materials, and "online" or electronic documentation ("SOFTWARE") are protected by international intellectual property laws and treaties. The SOFTWARE is licensed, not sold. All rights reserved.
- The SOFTWARE may interface with and/or communicate with, or may be later upgraded to interface with and/or communicate with additional software and/or systems provided by FORD MOTOR COMPANY.

IF YOU DO NOT AGREE TO THIS END USER LICENSE AGREEMENT ("EULA") DO NOT USE THE DEVICES OR COPY THE SOFTWARE. ANY USE OF THE SOFTWARE, INCLUDING BUT NOT LIMITED TO USE ON THE DEVICES, WILL CONSTITUTE YOUR AGREEMENT TO THIS EULA (OR RATIFICATION OF ANY PREVIOUS CONSENT).

GRANT OF SOFTWARE LICENSE: This EULA grants you the following license:

- You may use the SOFTWARE as installed on the DEVICES and as otherwise interfacing with systems and/or services provide by or through FORD MOTOR COMPANY or its third party software and service providers.

Customer Information

Description of Other Rights and Limitations.

- **Speech Recognition:** If the SOFTWARE includes speech recognition component(s), you should understand that speech recognition is an inherently statistical process and that recognition errors are inherent in the process. Neither FORD MOTOR COMPANY nor its suppliers shall be liable for any damages arising out of errors in the speech recognition process. It is your responsibility to monitor any speech recognition functions included in the system.
- **Limitations on Reverse Engineering, Decompilation and Disassembly:** You may not reverse engineer, decompile, translate, disassemble or attempt to discover any source code or underlying ideas or algorithms of the SOFTWARE nor permit others to reverse engineer, decompile or disassemble the SOFTWARE, except and only to the extent that such activity is expressly permitted by applicable law notwithstanding this limitation or to the extent as may be permitted by the licensing terms governing use of any open source components included with the SOFTWARE.
- **Limitations on Distributing, Copying, Modifying and Creating Derivative Works:** You may not distribute, copy, make modifications to or create derivative works based on the SOFTWARE, except and only to the extent that such activity is expressly permitted by applicable law notwithstanding this limitation or to the extent as may be permitted by the licensing terms governing use of any open source components included with the SOFTWARE.
- **Single EULA:** The end user documentation for the DEVICES and related systems and services may contain multiple EULAs, such as multiple translations and/or multiple media versions (e.g., in the user documentation and in the software). Even if you receive multiple EULAs, you are licensed to use only one (1) copy of the SOFTWARE.
- **SOFTWARE Transfer:** You may permanently transfer your rights under this EULA only as part of a sale or transfer of the DEVICES, provided you retain no copies, you transfer all of the SOFTWARE (including all component parts, the media and printed materials, any upgrades, and, if applicable, the Certificate(s) of Authenticity), and the recipient agrees to the terms of this EULA. If the SOFTWARE is an upgrade, any transfer must include all prior versions of the SOFTWARE.
- **Termination:** Without prejudice to any other rights, FORD MOTOR COMPANY may terminate this EULA if you fail to comply with the terms and conditions of this EULA.
- **Internet-Based Services Components:** The SOFTWARE may contain components that enable and facilitate the use of certain Internet-based services. You acknowledge and agree that FORD MOTOR COMPANY, third party software and service suppliers, its affiliates and/or its designated agent may automatically check the version of the SOFTWARE and/or its components that you are utilizing and may provide upgrades or supplements to the SOFTWARE that may be automatically downloaded to your DEVICES.

Customer Information

- **Additional Software/Services:** The SOFTWARE may permit FORD MOTOR COMPANY, third party software and service suppliers, its affiliates and/or its designated agent to provide or make available to you SOFTWARE updates, supplements, add-on components, or Internet-based services components of the SOFTWARE after the date you obtain your initial copy of the SOFTWARE ("Supplemental Components".) SOFTWARE updates may cause you to incur additional charges from your wireless service provider. If FORD MOTOR COMPANY or third party software and services suppliers provide or make available to you Supplemental Components and no other EULA terms are provided along with the Supplemental Components, then the terms of this EULA shall apply. FORD MOTOR COMPANY, its affiliates and/or its designated agent reserve the right to discontinue without liability any Internet-based services provided to you or made available to you through the use of the SOFTWARE.
- **Links to Third Party Sites:** The SOFTWARE may provide you with the ability to link to third party sites. The third party sites are not under the control of FORD MOTOR COMPANY, its affiliates and/or its designated agent. Neither FORD MOTOR COMPANY nor its affiliates nor its designated agent are responsible for (i) the contents of any third party sites, any links contained in third party sites, or any changes or updates to third party sites, or (ii) webcasting or any other form of transmission received from any third party sites. If the SOFTWARE provides links to third party sites, those links are provided to you only as a convenience, and the inclusion of any link does not imply an endorsement of the third party site by FORD MOTOR COMPANY, its affiliates and/or its designated agent.
- **Obligation to Drive Responsibly:** You recognize your obligation to drive responsibly and keep attention on the road. You will read and abide with the DEVICES operating instructions particularly as they pertain to safety and you agree to assume any risk associated with the use of the DEVICES.

UPGRADES AND RECOVERY MEDIA:

If the SOFTWARE is provided by FORD MOTOR COMPANY separate from the DEVICES on media such as a ROM chip, CD ROM disk(s) or via web download or other means, and is labeled "For Upgrade Purposes Only" or "For Recovery Purposes Only" you may install one (1) copy of such SOFTWARE onto the DEVICES as a replacement copy for the existing SOFTWARE, and use it in accordance with this EULA, including any additional EULA terms accompanying the upgrade SOFTWARE.

Customer Information

INTELLECTUAL PROPERTY RIGHTS:

All title and intellectual property rights in and to the SOFTWARE (including but not limited to any images, photographs, animations, video, audio, music, text and "applets" incorporated into the SOFTWARE), the accompanying printed materials, and any copies of the SOFTWARE, are owned by FORD MOTOR COMPANY, or its affiliates or suppliers. The SOFTWARE is licensed, not sold. You may not copy the printed materials accompanying the SOFTWARE. All title and intellectual property rights in and to the content which may be accessed through use of the SOFTWARE is the property of the respective content owner and may be protected by applicable copyright or other intellectual property laws and treaties. This EULA grants you no rights to use such content outside its intended use. All rights not specifically granted under this EULA are reserved by FORD MOTOR COMPANY, its affiliates, and third party software and service providers and suppliers. Use of any on-line services which may be accessed through the SOFTWARE may be governed by the respective terms of use relating to such services. If this SOFTWARE contains documentation that is provided only in electronic form, you may print one copy of such electronic documentation.

EXPORT RESTRICTIONS:

You acknowledge that the SOFTWARE is subject to U.S. and European Union export jurisdiction. You agree to comply with all applicable international and national laws that apply to the SOFTWARE, including the U.S. Export Administration Regulations, as well as end-user, end-use and destination restrictions issued by U.S. and other governments.

TRADEMARKS: This EULA does not grant you any rights in connection with any trademarks or service marks of FORD MOTOR COMPANY, its affiliates, and third party software and service providers.

PRODUCT SUPPORT: Please refer to FORD MOTOR COMPANY instructions provided in the documentation for the DEVICES product support, such as the vehicle owner guide.

Should you have any questions concerning this EULA, or if you desire to contact FORD MOTOR COMPANY for any other reason, please refer to the address provided in the documentation for the DEVICES.

No Liability for Certain Damages:

EXCEPT AS PROHIBITED BY LAW, FORD MOTOR COMPANY, ANY THIRD PARTY SOFTWARE OR SERVICES SUPPLIERS, AND THEIR AFFILIATES SHALL HAVE NO LIABILITY FOR ANY INDIRECT, SPECIAL, CONSEQUENTIAL OR INCIDENTAL DAMAGES ARISING FROM OR IN CONNECTION WITH THE USE OR PERFORMANCE OF THE SOFTWARE. THIS LIMITATION SHALL APPLY EVEN IF ANY REMEDY FAILS OF ITS ESSENTIAL PURPOSE. THERE ARE NO WARRANTIES OTHER THAN THOSE THAT MAY BE EXPRESSLY PROVIDED FOR YOUR NEW VEHICLE.

SYNC® Automotive Important Safety Information Read and follow instructions:

- Before using your SYNC® system, read and follow all instructions and safety information provided in this end user manual ("Owner Guide".) Not following precautions found in the Owner Guide can lead to an accident or other serious injuries.

Customer Information

General Operation

- **Voice Command Control:** Certain functions within the SYNC® system may be accomplished using voice commands. Using voice commands while driving helps you to operate the system without removing your hands from the wheel or eyes from the road.
- **Prolonged Views of Screen:** Do not access any function requiring a prolonged view of the screen while you are driving. Pull over in a safe and legal manner before attempting to access a function of the system requiring prolonged attention.
- **Volume Setting:** Do not raise the volume excessively. Keep the volume at a level where you can still hear outside traffic and emergency signals while driving. Driving while unable to hear these sounds could cause an accident.
- **Navigation Features:** Any navigation features included in the system are intended to provide turn by turn instructions to get you to a desired destination. Please make certain all persons using this system carefully read and follow instructions and safety information fully.
- **Distraction Hazard:** Any navigation features may require manual (non-verbal) setup. Attempting to perform such set-up or insert data while driving can distract your attention and could cause an accident or other serious injury. Stop the vehicle in a safe and legal manner before attempting these operations.
- **Let Your Judgment Prevail:** Any navigation features are provided only as an aid. Make your driving decisions based on your observations of local conditions and existing traffic regulations. Any such feature is not a substitute for your personal judgment. Any route suggestions made by this system should never replace any local traffic regulations or your personal judgment or knowledge of safe driving practices.
- **Route Safety:** Do not follow the route suggestions if doing so would result in an unsafe or illegal maneuver, if you would be placed in an unsafe situation, or if you would be directed into an area that you consider unsafe. The driver is ultimately responsible for the safe operation of the vehicle and therefore, must evaluate whether it is safe to follow the suggested directions.
- **Potential Map Inaccuracy:** Maps used by this system may be inaccurate because of changes in roads, traffic controls or driving conditions. Always use good judgment and common sense when following the suggested routes.
- **Emergency Services:** Do not rely on any navigation features included in the system to route you to emergency services. Ask local authorities or an emergency services operator for these locations. Not all emergency services such as police, fire stations, hospitals and clinics are likely to be contained in the map database for such navigation features.

Customer Information

Your Responsibilities and Assumptions of Risk

- You agree to each of the following: (a) Any use of the SOFTWARE while driving an automobile or other vehicle in violation of applicable law or otherwise driving in an unsafe manner presents a significant risk of distracted driving and should not be attempted under any circumstances; (b) Use of the SOFTWARE at excessive volume poses a significant risk of hearing damage and should not be attempted under any circumstances; (c) The SOFTWARE may not be compatible with new or different versions of an operating system, third party software, or third party services, and the SOFTWARE may potentially cause a critical failure of an operating system, third party software, or third party service. (d) Any third party service accessed by or third party software used with the SOFTWARE (I) may charge an additional fee for access, (ii) may not work correctly, on an uninterrupted basis, or error free, (iii) may change streaming formats or discontinue operation, (iv) may contain adult, profane or offensive content; and (v) may contain inaccurate, false or misleading traffic, weather, financial or safety information or other content; and (e) Use of the SOFTWARE may cause you to incur additional charges from your wireless service provider (WSP) and any data or minute calculators that may be included in the software program are for reference only, are not warranted in any way and should not be relied upon in anyway.
- When using the SOFTWARE, you agree to be responsible for and assume the entire risk to the items set forth in Section (a) – (e) above.

Disclaimer of Warranty

YOU EXPRESSLY ACKNOWLEDGE AND AGREE THAT USE OF THE DEVICES AND SOFTWARE IS AT YOUR SOLE RISK AND THAT THE ENTIRE RISK AS TO SATISFACTORY QUALITY, PERFORMANCE, COMPATIBILITY, ACCURACY AND EFFORT IS WITH YOU. TO THE MAXIMUM EXTENT PERMITTED BY APPLICABLE LAW, THE SOFTWARE AND ANY THIRD PARTY SOFTWARE OR THIRD-PARTY SERVICES ARE PROVIDED "AS IS" AND "AS AVAILABLE", WITH ALL FAULTS AND WITHOUT WARRANTY OF ANY KIND, AND FORD MOTOR COMPANY HEREBY DISCLAIMS ALL WARRANTIES AND CONDITIONS WITH RESPECT TO THE SOFTWARE, THIRD PARTY SOFTWARE, AND THIRD-PARTY SERVICES, EITHER EXPRESS, IMPLIED OR STATUTORY, INCLUDING, BUT NOT LIMITED TO, THE IMPLIED WARRANTIES AND/OR CONDITIONS OF MERCHANTABILITY, OF SATISFACTORY QUALITY, OF FITNESS FOR AN PARTICULAR PURPOSE, OF ACCURACY, OF QUIET ENJOYMENT, AND NON-INFRINGEMENT OF THIRD-PARTY RIGHTS. FORD MOTOR COMPANY DOES NOT WARRANT (a) AGAINST INTERFERENCE WITH YOUR ENJOYMENT OF THE SOFTWARE, THIRD PARTY SOFTWARE, OR THIRD-PARTY SERVICES, (b) THAT THE SOFTWARE, THIRD PARTY SOFTWARE, OR THIRD-PARTY SERVICES WILL MEET YOUR REQUIREMENTS, (c) THAT THE OPERATION OF THE SOFTWARE, THIRD PARTY SOFTWARE, OR THIRD-PARTY SERVICES WILL BE UNINTERRUPTED OR ERROR-FREE, (d) OR THAT DEFECTS IN THE SOFTWARE, THIRD PARTY SOFTWARE, OR THIRD-PARTY SERVICES WILL BE CORRECTED. NO ORAL OR WRITTEN INFORMATION OR ADVICE GIVEN BY FORD MOTOR COMPANY OR ITS AUTHORIZED REPRESENTATIVE SHALL

Customer Information

CREATE A WARRANTY. SHOULD THE SOFTWARE, THIRD PARTY SOFTWARE, OR THIRD-PARTY SERVICES PROVE DEFECTIVE, YOU ASSUME THE ENTIRE COST OF ALL NECESSARY SERVICING, REPAIR OR CORRECTION. SOME JURISDICTIONS DO NOT ALLOW THE DISCLAIMER OF IMPLIED WARRANTIES OR LIMITATIONS ON APPLICABLE STATUTORY RIGHTS OF A CONSUMER, SO THE ABOVE DISCLAIMER MAY NOT FULLY APPLY TO YOU. THE SOLE WARRANTY PROVIDED BY FORD MOTOR COMPANY SHALL BE FOUND IN THE WARRANTY INFORMATION INCLUDING WITH YOUR OWNER GUIDE. TO THE EXTENT THAT THERE IS ANY CONFLICT BETWEEN THE TERMS OF THIS SECTION AND THE WARRANTY BOOKLET, THE WARRANTY BOOKLET SHALL CONTROL.

Applicable Law, Venue, Jurisdiction

- The laws of the State of Michigan govern this EULA and Your use of the SOFTWARE. Your use of the SOFTWARE may also be subject to other local, state, national, or international laws. Any litigation arising out of or related to this EULA shall be brought and maintained exclusively in a court of the State of Michigan located in Wayne County or in the United States District Court for the Eastern District of Michigan. You hereby consent to submit to the personal jurisdiction of a court in the State of Michigan located in Wayne County and the United States District Court for the Eastern District of Michigan for any dispute arising out of or relating to this EULA.

Binding Arbitration and Class Action Waiver

(a) Application. This Section applies to any dispute EXCEPT IT DOES NOT INCLUDE A DISPUTE RELATING TO COPYRIGHT INFRINGEMENT, OR TO THE ENFORCEMENT OR VALIDITY OF YOUR, FORD MOTOR COMPANY, OR ANY OF FORD MOTOR COMPANY'S LICENSORS' INTELLECTUAL PROPERTY RIGHTS.

Dispute means any dispute, action, or other controversy between You and FORD MOTOR COMPANY, other than the exceptions listed above, concerning the SOFTWARE (including its price) or this EULA, whether in contract, warranty, tort, statute, regulation, ordinance, or any other legal or equitable basis.

(b) Notice of Dispute. In the event of a Dispute, You or FORD MOTOR COMPANY must give the other a "Notice of Dispute", which is a written statement of the name, address, and contact information of the party giving it, the facts giving rise to the dispute, and the relief requested. You and FORD MOTOR COMPANY will attempt to resolve any dispute through informal negotiation within 60 days from the date the Notice of Dispute is sent. After 60 days, You or FORD MOTOR COMPANY may commence arbitration.

(c) Small claims court. You may also litigate any dispute in small claims court in your county of residence or FORD MOTOR COMPANY'S principal place of business, if the dispute meets all requirements to be heard in the small claims court. You may litigate in small claims court whether or not You negotiated informally first.

(d) Binding arbitration. If You and FORD MOTOR COMPANY, do not resolve any dispute by informal negotiation or in small claims court, any other effort to resolve the dispute will be conducted exclusively by binding arbitration. You are giving up

Customer Information

the right to litigate (or participate in as a party or class member) all disputes in court before a judge or jury. Instead, all disputes will be resolved before a neutral arbitrator, whose decision will be final except for a limited right of appeal under the Federal Arbitration Act. Any court with jurisdiction over the parties may enforce the arbitrator's award.

(e) Class action waiver. Any proceedings to resolve or litigate any dispute in any forum will be conducted solely on an individual basis. Neither you nor FORD MOTOR COMPANY, will seek to have any dispute heard as a class action, as a private attorney general action, or in any other proceeding in which any party acts or proposes to act in a representative capacity. No arbitration or proceeding will be combined with another without the prior written consent of all parties to all affected arbitrations or proceedings.

(f) Arbitration procedure. Any arbitration will be conducted by the American Arbitration Association (the "AAA"), under its Commercial Arbitration Rules. If You are an individual and use the SOFTWARE for personal or vehicle use, or if the value of the dispute is \$75,000 or less whether or not You are an individual or how You use the SOFTWARE, the AAA Supplementary Procedures for Consumer-Related Disputes will also apply. To commence arbitration, submit a Commercial Arbitration Rules Demand for Arbitration form to the AAA. You may request a telephonic or in-person hearing by following the AAA rules. In a dispute involving \$10,000 or less, any hearing will be telephonic unless the arbitrator finds good cause to hold an in-person hearing instead. For more information, see adr.org or call 1-800-778-7879. You agree to commence arbitration only in your county of residence or FORD MOTOR COMPANY'S principal place of business. The arbitrator

may award the same damages to you individually as a court could. The arbitrator may award declaratory or injunctive relief only to you individually, and only to the extent required to satisfy your individual claim.

(g) Arbitration fees and incentives.

- I. Disputes involving \$75,000 or less. FORD MOTOR COMPANY will promptly reimburse your filing fees and pay the AAA's and arbitrator's fees and expenses. If you reject FORD MOTOR COMPANY'S last written settlement offer made before the arbitrator was appointed ("last written offer"), your dispute goes all the way to an arbitrator's decision (called an "award"), and the arbitrator awards you more than the last written offer, FORD MOTOR COMPANY will give you three incentives: (1) pay the greater of the award or \$1,000; (2) pay twice your reasonable attorney's fees, if any; and (3) reimburse any expenses (including expert witness fees and costs) that your attorney reasonably accrues for investigating, preparing, and pursuing your claim in arbitration. The arbitrator will determine the amounts.
- ii. Disputes involving more than \$75,000. The AAA rules will govern payment of filing fees and the AAA's and arbitrator's fees and expenses.
- iii. Disputes involving any amount. In any arbitration you commence, FORD MOTOR COMPANY will seek its AAA or arbitrator's fees and expenses, or Your filing fees it reimbursed, only if the arbitrator finds the arbitration frivolous or brought for an improper purpose. In any arbitration FORD MOTOR COMPANY commences, it will pay all

Customer Information

filing, AAA, and arbitrator's fees and expenses. It will not seek its attorney's fees or expenses from you in any arbitration. Fees and expenses are not counted in determining how much a dispute involves.

(h) Claims or disputes must be filed within one year. To the extent permitted by law, any claim or dispute under this EULA to which this Section applies must be filed within one year in small claims court (Section c) or in arbitration (Section d). The one-year period begins when the claim or dispute first could be filed. If such a claim or dispute is not filed within one year, it is permanently barred.

(i) Severability. If the class action waiver (Section e) is found to be illegal or unenforceable as to all or some parts of a dispute, then that portion of Section e will not apply to those parts. Instead, those parts will be severed and proceed in a court of law, with the remaining parts proceeding in arbitration. If any other provision of that portion Section e is found to be illegal or unenforceable, that provision will be severed with the remainder of Section e remaining in full force and effect.

Telenav Software End User License Agreement

Please read these terms and conditions carefully before you use the TeleNav Software. Your use of the TeleNav Software indicates that you accept these terms and conditions. If you do not accept these terms and conditions, do not break the seal of the package, launch, or otherwise use the TeleNav Software. TeleNav may revise this Agreement and the privacy policy at any time, with or without notice to you. You agree to visit <http://www.telenav.com> from time to time to review the then current version of this Agreement and of the privacy policy.

1. Safe and Lawful Use

You acknowledge that devoting attention to the TeleNav Software may pose a risk of injury or death to you and others in situations that otherwise require your undivided attention, and you therefore agree to comply with the following when using the TeleNav Software:

- (a) observe all traffic laws and otherwise drive safely;
- (b) use your own personal judgment while driving. If you feel that a route suggested by the TeleNav Software instructs you to perform an unsafe or illegal maneuver, places you in an unsafe situation, or directs you into an area that you consider to be unsafe, do not follow such instructions;
- (c) do not input destinations, or otherwise manipulate the TeleNav Software, unless your vehicle is stationary and parked;
- (d) do not use the TeleNav Software for any illegal, unauthorized, unintended, unsafe, hazardous, or unlawful purposes, or in any manner inconsistent with this Agreement;
- (e) arrange all GPS and wireless devices and cables necessary for use of the TeleNav Software in a secure manner in your vehicle so that they will not interfere with your driving and will not prevent the operation of any safety device (such as an airbag).

You agree to indemnify and hold TeleNav harmless against all claims resulting from any dangerous or otherwise inappropriate use of the TeleNav Software in any moving vehicle, including as a result of your failure to comply with the directions above.

Customer Information

2. Account Information

You agree: (a) when registering the TeleNav Software, to provide TeleNav with true, accurate, current, and complete information about yourself, and (b) to inform TeleNav promptly of any changes to such information, and to keep it true, accurate, current and complete.

3. Software License

- Subject to your compliance with the terms of this Agreement, TeleNav hereby grants to you a personal, non-exclusive, non-transferable license (except as expressly permitted below in connection with your permanent transfer of the TeleNav Software license), without the right to sublicense, to use the TeleNav Software (in object code form only) in order to access and use the TeleNav Software. This license shall terminate upon any termination or expiration of this Agreement. You agree that you will use the TeleNav Software only for your personal business or leisure purposes, and not to provide commercial navigation services to other parties.

3.1 License Limitations

- **(a)** reverse engineer, decompile, disassemble, translate, modify, alter or otherwise change the TeleNav Software or any part thereof; **(b)** attempt to derive the source code, audio library or structure of the TeleNav Software without the prior express written consent of TeleNav; **(c)** remove from the TeleNav Software, or alter, any of TeleNav's or its suppliers' trademarks, trade names, logos, patent or copyright notices, or other notices or markings; **(d)**

distribute, sublicense or otherwise transfer the TeleNav Software to others, except as part of your permanent transfer of the TeleNav Software; or **(e)** use the TeleNav Software in any manner that

- i. infringes the intellectual property or proprietary rights, rights of publicity or privacy or other rights of any party,
- ii. violates any law, statute, ordinance or regulation, including but not limited to laws and regulations related to spamming, privacy, consumer and child protection, obscenity or defamation, or
- iii. is harmful, threatening, abusive, harassing, tortuous, defamatory, vulgar, obscene, libelous, or otherwise objectionable; and (f) lease, rent out, or otherwise permit unauthorized access by third parties to the TeleNav Software without advanced written permission of TeleNav.

4. Disclaimers

- To the fullest extent permissible pursuant to applicable law, in no event will TeleNav, its licensors and suppliers, or agents or employees of any of the foregoing, be liable for any decision made or action taken by you or anyone else in reliance on the information provided by the TeleNav Software. TeleNav also does not warrant the accuracy of the map or other data used for the TeleNav Software. Such data may not always reflect reality due to, among other things, road closures, construction, weather, new roads and other changing conditions. You are responsible for the entire risk arising out of your use of the TeleNav Software. For example but without limitation, you agree not to rely on the TeleNav Software for critical navigation in areas where the well-being or survival of you or others

Customer Information

is dependent on the accuracy of navigation, as the maps or functionality of the TeleNav Software are not intended to support such high risk applications, especially in more remote geographical areas.

- TELENAV EXPRESSLY DISCLAIMS AND EXCLUDES ALL WARRANTIES IN CONNECTION WITH THE TELENAV SOFTWARE, WHETHER STATUTORY, EXPRESS OR IMPLIED, INCLUDING ALL WARRANTIES WHICH MAY ARISE FROM COURSE OF DEALING, CUSTOM OR TRADE AND INCLUDING, BUT NOT LIMITED TO, THE IMPLIED WARRANTIES OF MERCHANTABILITY, FITNESS FOR A PARTICULAR PURPOSE AND NON-INFRINGEMENT OF THIRD PARTY RIGHTS WITH RESPECT TO THE TELENAV SOFTWARE.
- Certain jurisdictions do not permit the disclaimer of certain warranties, so this limitation may not apply to you.

5. Limitation of Liability

- TO THE EXTENT PERMITTED UNDER APPLICABLE LAW, UNDER NO CIRCUMSTANCES SHALL TELENAV OR ITS LICENSORS AND SUPPLIERS BE LIABLE TO YOU OR TO ANY THIRD PARTY FOR ANY INDIRECT, INCIDENTAL, CONSEQUENTIAL, SPECIAL OR EXEMPLARY DAMAGES (INCLUDING IN EACH CASE, BUT NOT LIMITED TO, DAMAGES FOR THE INABILITY TO USE THE EQUIPMENT OR ACCESS DATA, LOSS OF DATA, LOSS OF BUSINESS, LOSS OF PROFITS, BUSINESS INTERRUPTION OR THE LIKE) ARISING OUT OF THE USE OF OR INABILITY TO USE THE TELENAV SOFTWARE, EVEN IF TELENAV HAS BEEN ADVISED OF THE POSSIBILITY OF SUCH DAMAGES. NOTWITHSTANDING ANY DAMAGES THAT YOU MIGHT INCUR FOR ANY

REASON WHATSOEVER (INCLUDING, WITHOUT LIMITATION, ALL DAMAGES REFERENCED HEREIN AND ALL DIRECT OR GENERAL DAMAGES IN CONTRACT, TORT (INCLUDING NEGLIGENCE) OR OTHERWISE), THE ENTIRE LIABILITY OF TELENAV AND OF ALL OF TELENAV'S SUPPLIERS SHALL BE LIMITED TO THE AMOUNT ACTUALLY PAID BY YOU FOR THE TELENAV SOFTWARE. SOME STATES AND/OR JURISDICTIONS DO NOT ALLOW THE EXCLUSION OR LIMITATION OF INCIDENTAL OR CONSEQUENTIAL DAMAGES, SO THE ABOVE LIMITATIONS OR EXCLUSIONS MAY NOT APPLY TO YOU.

6. Arbitration and Governing Law

- You agree that any dispute, claim or controversy arising out of or relating to this Agreement or the TeleNav Software shall be settled by independent arbitration involving a neutral arbitrator and administered by the American Arbitration Association in the County of Santa Clara, California. The arbitrator shall apply the Commercial Arbitration Rules of the American Arbitration Association, and the judgment upon the award rendered by the arbitrator may be entered by any court having jurisdiction. Note that there is no judge or jury in an arbitration proceeding and the decision of the arbitrator shall be binding upon both parties. You expressly agree to waive your right to a jury trial. This Agreement and performance hereunder will be governed by and construed in accordance with the laws of the State of California, without giving effect to its conflict of law provisions. To the extent judicial action is necessary in connection with the binding arbitration, both TeleNav and you agree to submit

Customer Information

to the exclusive jurisdiction of the courts of the County of Santa Clara, California. The United Nations Convention on Contracts for the International Sale of Goods shall not apply.

7. Assignment

- You may not resell, assign, or transfer this Agreement or any of your rights or obligations, except in totality, in connection with your permanent transfer of the TeleNav Software, and expressly conditioned upon the new user of the TeleNav Software agreeing to be bound by the terms and conditions of this Agreement. Any such sale, assignment or transfer that is not expressly permitted under this paragraph will result in immediate termination of this Agreement, without liability to TeleNav, in which case you and all other parties shall immediately cease all use of the TeleNav Software. Notwithstanding the foregoing, TeleNav may assign this Agreement to any other party at any time without notice, provided the assignee remains bound by this Agreement.

8. Miscellaneous

8.1

This Agreement constitutes the entire agreement between TeleNav and you with respect to the subject matter hereof.

8.2

Except for the limited licenses expressly granted in this Agreement, TeleNav retains all right, title and interest in and to the TeleNav Software, including without limitation all related intellectual property rights. No licenses or other rights which are not expressly granted in this Agreement are intended to, or shall be, granted or

conferred by implication, statute, inducement, estoppel or otherwise, and TeleNav and its suppliers and licensors hereby reserve all of their respective rights other than the licenses explicitly granted in this Agreement.

8.3

By using the TeleNav Software, you consent to receive from TeleNav all communications, including notices, agreements, legally required disclosures or other information in connection with the TeleNav Software (collectively, "Notices") electronically. TeleNav may provide such Notices by posting them on TeleNav's Website or by downloading such Notices to your wireless device. If you desire to withdraw your consent to receive Notices electronically, you must discontinue your use of the TeleNav Software.

8.4

TeleNav's or your failure to require performance of any provision shall not affect that party's right to require performance at any time thereafter, nor shall a waiver of any breach or default of this Agreement constitute a waiver of any subsequent breach or default or a waiver of the provision itself.

8.5

If any provision herein is held unenforceable, then such provision will be modified to reflect the intention of the parties, and the remaining provisions of this Agreement will remain in full force and effect.

Customer Information

8.6

The headings in this Agreement are for convenience of reference only, will not be deemed to be a part of this Agreement, and will not be referred to in connection with the construction or interpretation of this Agreement. As used in this Agreement, the words "include" and "including" and variations thereof, will not be deemed to be terms of limitation, but rather will be deemed to be followed by the words "without limitation".

9. Other Vendors Terms and Conditions

- The Telenav Software utilizes map and other data licensed to Telenav by third party vendors for the benefit of you and other end users. This Agreement includes end-user terms applicable to these companies (included at the end of this Agreement), and thus your use of the Telenav Software is also subject to such terms. You agree to comply with the following additional terms and conditions, which are applicable to Telenav's third party vendor licensors.

9.1 End User Terms Required by HERE North America, LLC

The data ("Data") is provided for your personal, internal use only and not for resale. It is protected by copyright, and is subject to the following terms and conditions which are agreed to by you, on the one hand, and Telenav ("Telenav") and its licensors (including their licensors and suppliers) on the other hand.

© 2013 HERE. All rights reserved.

The Data for areas of Canada includes information taken with permission from Canadian authorities, including: © Her Majesty the Queen in Right of Canada, © Queen's Printer for Ontario, © Canada Post Corporation, GeoBase®, © Department of Natural Resources Canada.

HERE holds a non-exclusive license from the United States Postal Service® to publish and sell ZIP+4® information.

©United States Postal Service® 2014. Prices are not established, controlled or approved by the United States Postal Service®. The following trademarks and registrations are owned by the USPS: United States Postal Service, USPS, and ZIP+4

The Data for Mexico includes certain data from Instituto Nacional de Estadística y Geografía.

9.2 End User Terms Required by NAV2 (Shanghai) Co., Ltd

The data ("Data") is provided for your personal, internal use only and not for resale. It is protected by copyright, and is subject to the following terms and conditions which are agreed to by you, on the one hand, and NAV2 (Shanghai) Co., Ltd ("NAV2") and its licensors (including their licensors and suppliers) on the other hand. 20xx. All rights reserved

Terms and Conditions

Permitted Use. You agree to use this Data together with the Telenav Software solely for the internal business and personal purposes for which you were licensed, and not for service bureau, time-sharing or other similar purposes. Accordingly, but subject to the restrictions set forth in the following paragraphs, you agree not to otherwise reproduce, copy, modify, decompile, disassemble, create any derivative works of, or reverse engineer any portion of this Data, and may not transfer or distribute it in any form, for any purpose, except to the extent permitted by mandatory laws.

Customer Information

Restrictions. Except where you have been specifically licensed to do so by Telenav, and without limiting the preceding paragraph, you may not use this Data (a) with any products, systems, or applications installed or otherwise connected to or in communication with vehicles, capable of vehicle navigation, positioning, dispatch, real time route guidance, fleet management or similar applications; or (b) with or in communication with any positioning devices or any mobile or wireless-connected electronic or computer devices, including without limitation cellular phones, palmtop and handheld computers, pagers, and personal digital assistants or PDAs.

Warning. The Data may contain inaccurate or incomplete information due to the passage of time, changing circumstances, sources used and the nature of collecting comprehensive geographic data, any of which may lead to incorrect results.

No Warranty. This Data is provided to you “as is,” and you agree to use it at your own risk. Telenav and its licensors (and their licensors and suppliers) make no guarantees, representations or warranties of any kind, express or implied, arising by law or otherwise, including but not limited to, content, quality, accuracy, completeness, effectiveness, reliability, fitness for a particular purpose, usefulness, use or results to be obtained from this Data, or that the Data or server will be uninterrupted or error-free.

Disclaimer of Warranty: TELENAV AND ITS LICENSORS (INCLUDING THEIR LICENSORS AND SUPPLIERS) DISCLAIM ANY WARRANTIES, EXPRESS OR IMPLIED, OF QUALITY, PERFORMANCE, MERCHANTABILITY, FITNESS FOR A

PARTICULAR PURPOSE OR NON-INFRINGEMENT. Some States, Territories and Countries do not allow certain warranty exclusions, so to that extent the above exclusion may not apply to you.

Disclaimer of Liability: TELENAV AND ITS LICENSORS (INCLUDING THEIR LICENSORS AND SUPPLIERS) SHALL NOT BE LIABLE TO YOU: IN RESPECT OF ANY CLAIM, DEMAND OR ACTION, IRRESPECTIVE OF THE NATURE OF THE CAUSE OF THE CLAIM, DEMAND OR ACTION ALLEGING ANY LOSS, INJURY OR DAMAGES, DIRECT OR INDIRECT, WHICH MAY RESULT FROM THE USE OR POSSESSION OF THE INFORMATION; OR FOR ANY LOSS OF PROFIT, REVENUE, CONTRACTS OR SAVINGS, OR ANY OTHER DIRECT, INDIRECT, INCIDENTAL, SPECIAL OR CONSEQUENTIAL DAMAGES ARISING OUT OF YOUR USE OF OR INABILITY TO USE THIS INFORMATION, ANY DEFECT IN THE INFORMATION, OR THE BREACH OF THESE TERMS OR CONDITIONS, WHETHER IN AN ACTION IN CONTRACT OR TORT OR BASED ON A WARRANTY, EVEN IF TELENAV OR ITS LICENSORS HAVE BEEN ADVISED OF THE POSSIBILITY OF SUCH DAMAGES. Some States, Territories and Countries do not allow certain liability exclusions or damages limitations, so to that extent the above may not apply to you.

Export Control. You shall not export from anywhere any part of the Data or any direct product thereof except in compliance with, and with all licenses and approvals required under, applicable export laws, rules and regulations, including but not limited to the laws, rules and regulations administered by the Office of Foreign Assets Control of the U.S. Department of Commerce and the Bureau of Industry and Security of the U.S. Department of Commerce. To the extent that any such

Customer Information

export laws, rules or regulations prohibit HERE from complying with any of its obligations hereunder to deliver or distribute Data, such failure shall be excused and shall not constitute a breach of this Agreement.

Entire Agreement. These terms and conditions constitute the entire agreement between Telenav (and its licensors, including their licensors and suppliers) and you pertaining to the subject matter hereof, and supersedes in their entirety any and all written or oral agreements previously existing between us with respect to such subject matter.

Governing Law. The above terms and conditions shall be governed by the laws of the State of Illinois [insert "Netherlands" where European HERE Data is used], without giving effect to (i) its conflict of laws provisions, or (ii) the United Nations Convention for Contracts for the International Sale of Goods, which is explicitly excluded. You agree to submit to the jurisdiction of the State of Illinois [insert "The Netherlands" where European HERE Data is used] for any and all disputes, claims and actions arising from or in connection with the Data provided to you hereunder.

Government End Users. If the Data is being acquired by or on behalf of the United States government or any other entity seeking or applying rights similar to those customarily claimed by the United States government, this Data is a "commercial item" as that term is defined at 48 C.F.R. ("FAR") 2.101, is licensed in accordance with these End-User Terms, and each copy of Data delivered or otherwise furnished shall be marked and embedded as appropriate with the following "Notice of Use," and shall be treated in accordance with such Notice:

NOTICE OF USE
CONTRACTOR (MANUFACTURER/SUPPLIER) NAME: HERE
CONTRACTOR (MANUFACTURER/SUPPLIER) ADDRESS: c/o Nokia, 425 West Randolph Street, Chicago, Illinois 60606
This Data is a commercial item as defined in FAR 2.101 and is subject to these End-User Terms under which this Data was provided.
© 1987 – 2014 HERE – All rights reserved.

If the Contracting Officer, federal government agency, or any federal official refuses to use the legend provided herein, the Contracting Officer, federal government agency, or any federal official must notify HERE prior to seeking additional or alternative rights in the Data.

I. US/Canada Territory

A. United States Data. The End-User Terms for any Application containing Data for the United States shall contain the following notices:

"HERE holds a non-exclusive license from the United States Postal Service® to publish and sell ZIP+4® information."

"©United States Postal Service® 20XX. Prices are not established, controlled or approved by the United States Postal Service®. The following trademarks and registrations are owned by the USPS: United States Postal Service, USPS, and ZIP+4."

Customer Information

B. Canada Data. The following provisions apply to the Data for Canada, which may include or reflect data from third party licensors (“Third Party Data”), including Her Majesty the Queen in Right of Canada (“Her Majesty”), Canada Post Corporation (“Canada Post”) and the Department of Natural Resources of Canada (“NRCan”):

1. Disclaimer and Limitation: Client agrees that its use of the Third Party Data is subject to the following provisions:

a. Disclaimer: The Third Party Data is licensed on an “as is” basis. The licensors of such data, including Her Majesty, Canada Post and NRCan, make no guarantees, representations or warranties respecting such data, either express or implied, arising by law or otherwise, including but not limited to, effectiveness, completeness, accuracy or fitness for a particular purpose.

b. Limitation on Liability: The Third Party Data licensors, including Her Majesty, Canada Post and NRCan, shall not be liable: (i) in respect of any claim, demand or action, irrespective of the nature of the cause of the claim, demand or action alleging any loss, injury or damages, direct or indirect, which may result from the use or possession of such Data; or (ii) in any way for loss of revenues or contracts, or any other consequential loss of any kind resulting from any defect in the Data.

2. Copyright Notice: In connection with each copy of all or any portion of the Data for the Territory of Canada, Client shall affix in a conspicuous manner the following copyright notice on at least one of: (i) the label for the storage media of the copy; (ii) the packaging for the copy; or (iii) other materials packaged with the copy, such as user manuals or end user license agreements: “This data includes information taken with permission from Canadian authorities, including © Her Majesty the Queen in Right of Canada, © Queen’s Printer for Ontario, © Canada Post Corporation, GeoBase®, © The Department of Natural Resources Canada. All rights reserved.”

3. End-User Terms: Except as otherwise agreed by the parties, in connection with the provision of any portion of the Data for the Territory of Canada to End-Users as may be authorized under the Agreement, Client shall provide such End-Users, in a reasonably conspicuous manner, with terms (set forth with other end user terms required to be provided under the Agreement, or as otherwise may be provided, by Client) which shall include the following provisions on behalf of the Third Party Data licensors, including Her Majesty, Canada Post and NRCan:

The Data may include or reflect data of licensors, including Her Majesty the Queen in the Right of Canada (“Her Majesty”), Canada Post Corporation (“Canada Post”) and the Department of Natural Resources Canada (“NRCan”). Such data is licensed on an “as is” basis. The licensors, including Her Majesty, Canada Post and NRCan, make no guarantees, representations or warranties respecting such data,

Customer Information

either express or implied, arising by law or otherwise, including but not limited to, effectiveness, completeness, accuracy or fitness for a particular purpose. The licensors, including Her Majesty, Canada Post and NRCan, shall not be liable in respect of any claim, demand or action, irrespective of the nature of the cause of the claim, demand or action alleging any loss, injury or damages, direct or indirect, which may result from the use or possession of the data or the Data. The licensors, including Her Majesty, Canada Post and NRCan, shall not be liable in any way for loss of revenues or contracts, or any other consequential loss of any kind resulting from any defect in the data or the Data.

End User shall indemnify and save harmless the licensors, including Her Majesty, Canada Post and NRCan, and their officers, employees and agents from and against any claim, demand or action, irrespective of the nature of the cause of the claim, demand or action, alleging loss, costs, expenses, damages or injuries (including injuries resulting in death) arising out of the use or possession of the data or the Data.

4. Additional Provisions: The terms contained in this Section are in addition to all of the rights and obligations of the parties under the Agreement. To the extent that any of the provisions of this Section are inconsistent with, or conflict with, any other provisions of the Agreement, the provisions of this Section shall prevail.

II. Mexico. The following provision applies to the Data for Mexico, which includes certain data from the Instituto Nacional de Estadística y Geografía (“INEGI”):

A. Any and all copies of the Data and/or packaging containing Data for Mexico shall contain the following notice: “Fuente: INEGI (Instituto Nacional de Estadística y Geografía)”

III. Latin America Territory

A. Third Party Notices. Any and all copies of the Data and/or packaging relating thereto shall include the respective Third Party Notices set forth below and used as described below corresponding to the Territory (or portion thereof) included in such copy:

Territory	Notice
Argentina	IGN “INSTITUTO GEOGRAFICO NACIONAL ARGENTINO”
Ecuador	“INSTITUTO GEOGRAFICO MILITAR DEL ECUADOR AUTORIZACION N° IGM-2011-01- PCO-01 DEL 25 DE ENERO DE 2011” “source: © IGN 2009 - BD TOPO ®”
Guadeloupe, French Guiana and Martinique Mexico	“Fuente: INEGI (Instituto Nacional de Estadística y Geografía)”

IV. Middle East Territory

Customer Information

A. Third Party Notices. Any and all copies of the Data and/or packaging relating thereto shall include the respective Third Party Notices set forth below and used as described below corresponding to the Territory (or portion thereof) included in such copy:

Country	Notice
Jordan	“© Royal Jordanian Geographic Centre”. The foregoing notice requirement for Jordan Data is a material term of the Agreement. If Client or any of its permitted sublicensees (if any) fail to meet such requirement, HERE shall have the right to terminate Client’s license with respect to the Jordan Data.

B. Jordan Data. Client and its permitted sublicensees (if any) are restricted from licensing and/or otherwise distributing HERE’s database for the country of Jordan (“Jordan Data”) for use in Enterprise Applications to (i) non-Jordanian entities for use of the Jordan Data solely in Jordan or (ii) Jordan-based customers. In addition, Client, its permitted sublicensees (if any) and End-Users are restricted from using the Jordan Data in Enterprise Applications if such party is (i) a non-Jordanian entity using the Jordan Data solely in Jordan or (ii) a Jordan-based customer. For purposes of the foregoing, “Enterprise Applications” shall mean Geomarketing applications, GIS applications, mobile business asset management applications, call center applications, telematics applications, public organization Internet applications or for providing geocoding services.

V. Europe Territory

A. Use of Certain Traffic Codes in Europe

1. General Restrictions Applicable to Traffic Codes. Client acknowledges and agrees that in certain countries of the Europe Territory, Client will need to obtain rights directly from third party RDS-TMC code providers to receive and use the Traffic Codes in the Data and to deliver to End-Users Transactions in any way derived from or based on such Traffic Codes. For such countries, HERE shall deliver the Data incorporating Traffic Codes to Client only after receiving certification from Client of its having obtained such rights.

2. Display of Third Party Rights Legends for Belgium. Client shall, for each Transaction that uses Traffic Codes for Belgium, provide the following notice to the End-User: “Traffic Codes for Belgium are provided by the Ministerie van de Vlaamse Gemeenschap and the Ministère de l’Equipeement et des Transports.”

B. Paper Maps. With respect to any license granted to Client relating to making, selling or distributing paper maps (i.e., a map fixed on a paper or paper-like medium): (a) such license with respect to Data for the Territory of Great Britain is conditioned on Client’s entering into and complying with a separate written agreement with the Ordnance Survey (“OS”) to create and sell paper maps, Client’s paying to the OS any and all applicable paper map royalties, and Client’s complying with the OS copyright notice requirements; (b) such license for selling or otherwise distributing for charge with respect to Data for the Territory of Czech Republic

Customer Information

is conditioned on Client's obtaining prior written consent from Kartografie a.s.; (c) such license for selling or distributing with respect to Data for the Territory of Switzerland is conditioned on Client's obtaining a permit from Bundesamt für Landestopografie of Switzerland; (d) Client is restricted from using Data for the Territory of France to create paper maps with a scale between 1:5,000 and 1:250,000; and (e) Client is restricted from using any Data to create, sell or distribute paper maps that are the same or substantially similar, in terms of data content and specific use of color, symbols and scale, to paper maps published by the European national mapping agencies, including without limitation, Landervermessungämter of Germany, Topografische Dienst of the Netherlands, Nationaal Geografisch Instituut of Belgium, Bundesamt für Landestopografie of Switzerland, Bundesamt für Eich-und Vermessungswesen of Austria, and the National Land Survey of Sweden.

C. OS Enforcement. Without limiting Section IV(B) above, with respect to Data for the Territory of Great Britain, Client acknowledges and agrees that the Ordnance Survey ("OS") may bring a direct action against Client to enforce compliance with the OS copyright notice (see Section IV(D) below) and paper map requirements (see Section IV(B) above) contained in this Agreement.

D. Third Party Notices. Any and all copies of the Data and/or packaging relating thereto shall include the respective Third Party Notices set forth below and used as described below corresponding to the Territory (or portion thereof) included in such copy:

Country(ies) Notice

Austria	"© Bundesamt für Eich- und Vermessungswesen"
Croatia Cyprus, Estonia, Latvia, Lithuania, Moldova, Poland, Slovenia and/or Ukraine	"© EuroGeographics"
France	"source: © IGN 2009 – BD TOPO ®"
Germany	"Die Grundlegendaten wurden mit Genehmigung der zuständigen Behörden entnommen"
Great Britain	"Contains Ordnance Survey data © Crown copyright and database right 2010 Contains Royal Mail data © Royal Mail copyright and database right 2010"
Greece	"Copyright Geomatics Ltd."
Hungary	"Copyright © 2003; Top-Map Ltd."
Italy	"La Banca Dati Italiana è stata prodotta usando quale riferimento anche cartografia numerica ed al tratto prodotta e fornita dalla Regione Toscana."
Norway	"Copyright © 2000; Norwegian Mapping Authority"
Portugal	"Source: IgeoE – Portugal"

Customer Information

Spain	“Información geográfica propiedad del CNIG”
Sweden	“Based upon electronic data © National Land Survey Sweden.”
Switzerland	“Topografische Grundlage: © Bundesamt für Landestopographie.”

E. Respective Country Distribution. Client acknowledges that HERE has not received approvals to distribute map data for the following countries in such respective countries: Albania, Belarus, Kyrgyzstan, Moldova and Uzbekistan. HERE may update such list from time to time. The license rights granted to Client under this TL with respect to the Data for such countries are contingent upon Client's compliance with all applicable laws and regulations, including, without limitation, any required licenses or approvals to distribute the Application incorporating such Data in such respective countries.

VI. Australia Territory

A. Third Party Notices. Any and all copies of the Data and/or packaging relating thereto shall include the respective Third Party Notices set forth below and used as described below corresponding to the Territory (or portion thereof) included in such copy:

Copyright. Based on data provided under license from PSMA Australia Limited (www.pasma.com.au).

Product incorporates data which is © 20XX Telstra Corporation Limited, GM Holden Limited, Intelomatics Australia Pty Ltd and Continental Pty Ltd.

B. Third Party Notices for Australia. In addition to the foregoing, the End-User Terms for any Application containing RDS-TMC Traffic Codes for Australia shall contain the following notice: “Product incorporates traffic location codes which is © 20XX Telstra Corporation Limited and its licensors.”

AT&T Vehicle Network Carrier Telematics Disclosure

END USER FOR PURPOSES OF THIS SECTION MEANS YOU AND YOUR HEIRS, EXECUTORS, LEGAL PERSONAL REPRESENTATIVES AND PERMITTED ASSIGNS. FOR PURPOSES OF THIS SECTION “UNDERLYING WIRELESS SERVICE CARRIER” INCLUDES ITS AFFILIATES AND CONTRACTORS AND THEIR RESPECTIVE OFFICERS, DIRECTORS, EMPLOYEES, SUCCESSORS AND ASSIGNS. END USER HAS NO CONTRACTUAL RELATIONSHIP WITH THE UNDERLYING WIRELESS SERVICE CARRIER AND END USER IS NOT A THIRD PARTY BENEFICIARY OF ANY AGREEMENT BETWEEN FORD AND UNDERLYING CARRIER. END USER UNDERSTANDS AND AGREES THAT THE UNDERLYING CARRIER HAS NO LEGAL, EQUITABLE, OR OTHER LIABILITY OF ANY KIND TO END USER. IN ANY EVENT, REGARDLESS OF THE FORM OF THE ACTION, WHETHER FOR BREACH OF CONTRACT, WARRANTY, NEGLIGENCE, STRICT LIABILITY IN TORT OR OTHERWISE, END USER'S EXCLUSIVE REMEDY FOR CLAIMS ARISING IN ANY WAY IN CONNECTION WITH THIS AGREEMENT, FOR ANY CAUSE WHATSOEVER, INCLUDING BUT NOT LIMITED TO ANY FAILURE OR

Customer Information

DISRUPTION OF SERVICE PROVIDED HEREUNDER, IS LIMITED TO PAYMENT OF DAMAGES IN AN AMOUNT NOT TO EXCEED THE AMOUNT PAID BY END USER FOR THE SERVICES DURING THE TWO-MONTH PERIOD PRECEDING THE DATE THE CLAIM AROSE.

(ii) END USER AGREES TO INDEMNIFY AND HOLD HARMLESS THE UNDERLYING WIRELESS SERVICE CARRIER AND ITS OFFICERS, EMPLOYEES, AND AGENTS AGAINST ANY AND ALL CLAIMS, INCLUDING WITHOUT LIMITATION CLAIMS FOR LIBEL, SLANDER, OR ANY PROPERTY DAMAGE, PERSONAL INJURY OR DEATH, ARISING IN ANY WAY, DIRECTLY OR INDIRECTLY, IN CONNECTION WITH THIS AGREEMENT OR THE USE, FAILURE TO USE, OR INABILITY TO USE THE DEVICE EXCEPT WHERE THE CLAIMS RESULT FROM THE UNDERLYING CARRIER'S GROSS NEGLIGENCE OR WILLFUL MISCONDUCT. THIS INDEMNITY WILL SURVIVE THE TERMINATION OF THE AGREEMENT.

(iii) END USER HAS NO PROPERTY RIGHT IN ANY NUMBER ASSIGNED TO THE DEVICE.

(iv) END USER UNDERSTANDS THAT FORD AND THE UNDERLYING CARRIER CANNOT GUARANTY THE SECURITY OF WIRELESS TRANSMISSIONS, AND WILL NOT BE LIABLE FOR ANY LACK OF SECURITY RELATING TO THE USE OF THE SERVICES

THE SERVICE IS FOR [END USER'S] USE ONLY AND END USER MAY NOT RESELL THE SERVICE TO ANY OTHER PARTY END USER UNDERSTANDS THAT THE UNDERLYING CARRIER DOES NOT GUARANTEE ANY END USER UNINTERRUPTED SERVICE OR COVERAGE. THE UNDERLYING CARRIER DOES NOT WARRANT THAT END USERS CAN OR WILL BE LOCATED USING THE SERVICE. THE UNDERLYING CARRIER

MAKES NO WARRANTY, EXPRESS OR IMPLIED, OF MERCHANTABILITY OR FITNESS FOR A PARTICULAR PURPOSE, SUITABILITY, OR PERFORMANCE REGARDING ANY SERVICES OR GOODS, AND IN NO EVENT SHALL AT&T BE LIABLE, WHETHER OR NOT DUE TO ITS OWN NEGLIGENCE, FOR ANY: (A) ACT OR OMISSION OF A THIRD PARTY; (B) MISTAKES, OMISSIONS, INTERRUPTIONS, ERRORS, FAILURES TO TRANSMIT, DELAYS, OR DEFECTS IN THE SERVICE PROVIDED BY OR THROUGH THE UNDERLYING CARRIER; (C) DAMAGE OR INJURY CAUSED BY SUSPENSION OR TERMINATION BY THE UNDERLYING CARRIER; OR (D) DAMAGE OR INJURY CAUSED BY A FAILURE OR DELAY IN CONNECTING A CALL TO ANY ENTITY, INCLUDING 911 OR ANY OTHER EMERGENCY SERVICE. TO THE FULL EXTENT ALLOWED BY LAW, THE END USER RELEASES, INDEMNIFIES AND HOLDS THE UNDERLYING CARRIER HARMLESS FROM AND AGAINST ANY AND ALL CLAIMS OF ANY PERSON OR ENTITY FOR DAMAGES OF ANY NATURE ARISING IN ANY WAY FROM OR RELATING TO, DIRECTLY OR INDIRECTLY, SERVICES PROVIDED BY THE UNDERLYING CARRIER OR ANY PERSON'S USE THEREOF, INCLUDING CLAIMS ARISING IN WHOLE OR IN PART FROM THE ALLEGED NEGLIGENCE OF THE UNDERLYING CARRIER.

VII. China Territory

Personal Use Only

You agree to use this Data together with [insert name of Client Application] for the solely personal, non-commercial purposes for which you were licensed, and not for service bureau, time-sharing or other similar purposes. Accordingly, but subject to the restrictions set forth in the following paragraphs, you may copy this Data only as necessary for your personal use to (i)

Customer Information

view it, and (ii) save it, provided that you do not remove any copyright notices that appear and do not modify the Data in any way. You agree not to otherwise reproduce, copy, modify, decompile, disassemble or reverse engineer any portion of this Data, and may not transfer or distribute it in any form, for any purpose, except to the extent permitted by mandatory laws.

Restrictions

Except where you have been specifically licensed to do so by NAV2, and without limiting the preceding paragraph, you may not (a) use this Data with any products, systems, or applications installed or otherwise connected to or in communication with vehicles, capable of vehicle navigation, positioning, dispatch, real time route guidance, fleet management or similar applications; or (b) with or in communication with any positioning devices or any mobile or wireless-connected electronic or computer devices, including without limitation cellular phones, palmtop and handheld computers, pagers, and personal digital assistants or PDAs. You agree to cease using this Data if you fail to comply with these terms and conditions.

Limited Warranty

NAV2 warrants that (a) the Data will perform substantially in accordance with the accompanying written materials for a period of ninety (90) days from the date of receipt, and (b) any support services provided by NAV2 shall be substantially as described in applicable written materials provided to you by NAV2, and NAV2's support engineers will make commercially reasonable efforts to solve any problem issues.

Customer Remedies

NAV2 and its suppliers' entire liability and your exclusive remedy shall be, at NAV2's sole discretion, either (a) return of the price paid, if any, or (b) repair or replacement of the Data that do not meet NAV2's Limited Warranty and that are returned to NAV2 with a copy of your receipt. This Limited Warranty is void if failure of the Data has resulted from accident, abuse, or misapplication. Any replacement Data will be warranted for the remainder of the original warranty period or thirty (30) days, whichever is longer. Neither these remedies nor any product support services offered by NAV2 are available without proof of purchase from an authorized international source.

No Other Warranty:

EXCEPT FOR THE LIMITED WARRANTY SET FORTH ABOVE AND TO THE EXTENT PERMITTED BY APPLICABLE LAW, NAV2 AND ITS LICENSORS (INCLUDING THEIR LICENSORS AND SUPPLIERS) DISCLAIM ANY WARRANTIES, EXPRESS OR IMPLIED, OF QUALITY, PERFORMANCE, MERCHANTABILITY, FITNESS FOR A PARTICULAR PURPOSE, OWNERSHIP OR NON-INFRINGEMENT. Certain warranty exclusions may not be permitted under applicable law, so to that extent the above exclusion may not apply to you.

Limited Liability:

TO THE EXTENT PERMITTED BY APPLICABLE LAW, NAV2 AND ITS LICENSORS (INCLUDING THEIR LICENSORS AND SUPPLIERS) SHALL NOT BE LIABLE TO YOU: IN RESPECT OF ANY CLAIM, DEMAND OR ACTION, IRRESPECTIVE OF THE NATURE OF THE CAUSE OF THE CLAIM, DEMAND OR ACTION ALLEGING ANY LOSS, INJURY OR DAMAGES, DIRECT OR INDIRECT, WHICH MAY RESULT FROM THE USE OR POSSESSION OF THE INFORMATION; OR

Customer Information

FOR ANY LOSS OF PROFIT, REVENUE, CONTRACTS OR SAVINGS, OR ANY OTHER DIRECT, INDIRECT, INCIDENTAL, SPECIAL OR CONSEQUENTIAL DAMAGES ARISING OUT OF YOUR USE OF OR INABILITY TO USE THIS INFORMATION, ANY DEFECT IN THE INFORMATION, OR THE BREACH OF THESE TERMS OR CONDITIONS, WHETHER IN AN ACTION IN CONTRACT OR TORT OR BASED ON A WARRANTY, EVEN IF NAV2 OR ITS LICENSORS HAVE BEEN ADVISED OF THE POSSIBILITY OF SUCH DAMAGES. UNDER NO CIRCUMSTANCES SHALL NAV2'S OR ITS SUPPLIERS' LIABILITY HEREUNDER EXCEED THE PRICE PAID. Certain liability exclusions may not be permitted under applicable law, so to that extent the above exclusion may not apply to you.

Export Control

You agree not to export to anywhere any part of the Data provided to you or any direct product thereof except in compliance with, and with all licenses and approvals required under, applicable export laws, rules and regulations.

IP Protection

The Data are owned by NAV2 or its suppliers and are protected by applicable copyright and other intellectual property law and treaties. The Data are provided solely on the basis of a license to use, not sale.

Entire Agreement

These terms and conditions constitute the entire agreement between NAV2 (and its licensors, including their licensors and suppliers) and you pertaining to the subject matter hereof, and supersedes in their entirety any and all written or oral agreements previously existing between us with respect to such subject matter.

Governing Law.

The above terms and conditions shall be governed by the laws of the People's Republic of China, without giving effect to (i) its conflict of laws provisions, or (ii) the United Nations Convention for Contracts for the International Sale of Goods, which is explicitly excluded. Any dispute arising from or in connection with the Data provided to you hereunder shall be submitted to the Shanghai International Economic and Trade Arbitration Commission for arbitration.

Gracenote® Copyright

CD and music-related data from Gracenote, Inc., copyright©

2000-2007 Gracenote. Gracenote Software, copyright © 2000-2007 Gracenote. This product and service may practice one or more of the following U.S. Patents 5,987,525; 6,061,680; 6,154,773; 6,161,132; 6,230,192; 6,230,207; 6,240,459; 6,330,593 and other patents issued or pending. Some services supplied under license from Open Globe, Inc. for U.S. Patent 6,304,523.

Gracenote and CDDB are registered trademarks of Gracenote. The Gracenote logo and logotype, and the "Powered by Gracenote™" logo are trademarks of Gracenote.

Gracenote® End User License Agreement (EULA)

This device contains software from Gracenote, Inc. of 2000 Powell Street Emeryville, California 94608 ("Gracenote").

The software from Gracenote (the "Gracenote Software") enables this device to do disc and music file identification and obtain music-related information, including name, artist, track, and title information ("Gracenote Data") from online servers

Customer Information

("Gracenote Servers"), and to perform other functions. You may use Gracenote Data only by means of the intended End User functions of this device. This device may contain content belonging to Gracenote's providers. If so, all of the restrictions set forth herein with respect to Gracenote Data shall also apply to such content and such content providers shall be entitled to all of the benefits and protections set forth herein that are available to Gracenote. You agree that you will use the content from Gracenote ("Gracenote Content"), Gracenote Data, the Gracenote Software, and Gracenote Servers for your own personal, non-commercial use only. You agree not to assign, copy, transfer or transmit the Gracenote Content, Gracenote Software or any Gracenote Data (except in a Tag associated with a music file) to any third party. YOU AGREE NOT TO USE OR EXPLOIT GRACENOTE CONTENT, GRACENOTE DATA, THE GRACENOTE SOFTWARE, OR GRACENOTE SERVERS, EXCEPT AS EXPRESSLY PERMITTED HEREIN.

You agree that your non-exclusive licenses to use the Gracenote Content, Gracenote Data, the Gracenote Software, and Gracenote Servers will terminate if you violate these restrictions. If your licenses terminate, you agree to cease any and all use of the Gracenote Content, Gracenote Data, the Gracenote Software, and Gracenote Servers.

Gracenote, respectively, reserve all rights in Gracenote Data, the Gracenote Software, and the Gracenote Servers and Gracenote Content, including all ownership rights. Under no circumstances will either Gracenote become liable for any payment to you for any information that you provide,

including any copyrighted material or music file information. You agree that Gracenote may enforce its respective rights, collectively or separately, under this agreement against you, directly in each company's own name.

Gracenote uses a unique identifier to track queries for statistical purposes. The purpose of a randomly assigned numeric identifier is to allow Gracenote to count queries without knowing anything about who you are. For more information, see the web page at www.gracenote.com for the Gracenote Privacy Policy.

THE GRACENOTE SOFTWARE, EACH ITEM OF GRACENOTE DATA AND THE GRACENOTE CONTENT ARE LICENSED TO YOU "AS IS". NEITHER GRACENOTE MAKES ANY REPRESENTATIONS OR WARRANTIES, EXPRESS OR IMPLIED, REGARDING THE ACCURACY OF ANY GRACENOTE DATA FROM THE GRACENOTE SERVERS OR GRACENOTE CONTENT. GRACENOTE COLLECTIVELY AND SEPARATELY RESERVE THE RIGHT TO DELETE DATA AND/OR CONTENT FROM THE COMPANIES' RESPECTIVE SERVERS OR, IN THE CASE OF GRACENOTE, CHANGE DATA CATEGORIES FOR ANY CAUSE THAT GRACENOTE DEEMS SUFFICIENT. NO WARRANTY IS MADE THAT EITHER GRACENOTE CONTENT OR THE GRACENOTE SOFTWARE OR GRACENOTE SERVERS ARE ERROR-FREE OR THAT THE FUNCTIONING OF THE GRACENOTE SOFTWARE OR GRACENOTE SERVERS WILL BE UNINTERRUPTED. GRACENOTE IS NOT OBLIGATED TO PROVIDE YOU WITH ANY ENHANCED OR ADDITIONAL DATA TYPES THAT GRACENOTE MAY CHOOSE TO PROVIDE IN THE FUTURE AND IS FREE TO DISCONTINUE ITS ONLINE SERVICES AT ANY TIME. GRACENOTE DISCLAIM ALL WARRANTIES EXPRESS OR IMPLIED, INCLUDING, BUT NOT LIMITED TO,

Customer Information

IMPLIED WARRANTIES OF MERCHANTABILITY, FITNESS FOR A PARTICULAR PURPOSE, TITLE, AND NON-INFRINGEMENT. NEITHER GRACENOTE WARRANTS THE RESULTS THAT WILL BE OBTAINED BY YOUR USE OF THE GRACENOTE SOFTWARE OR ANY GRACENOTE SERVER. IN NO CASE WILL GRACENOTE BE LIABLE FOR ANY CONSEQUENTIAL OR INCIDENTAL DAMAGES OR FOR ANY LOST PROFITS OR LOST REVENUES FOR ANY REASON WHATSOEVER. © Gracenote 2007.

Taiwan Territory

According to the "Technical Specifications for Low Power Radio Frequency Equipment" formulated by the National Communications and Communication Committee of the Executive Yuan: 3.8.2. For the low-power radio frequency equipment that has obtained the verification certificate, the company, firm or user shall not change the frequency, increase the power or change the characteristics and functions of the original design without authorization.

The use of low-power radio frequency equipment must not affect flight safety and interfere with legal communications: when the system detects interference, immediately stop using it until there is no interference.

The aforementioned legal communication refers to the wireless communication operated in accordance with the provisions of the Telecommunications Management Law. Low-power radio frequency equipment needs to endure the interference of legal communication or industrial, scientific and medical radio wave radiation electrical equipment.

SUNA TRAFFIC CHANNEL – TERMS AND CONDITIONS

By activating, using and/or accessing the SUNA Traffic Channel, SUNA Predictive or other content or material provided by Intelomatics (together, **SUNA Products and/or Services**), you must accept certain terms and conditions. The following is a brief summary of the terms and conditions that apply to you. To view the full terms and conditions relevant to your use of the SUNA Products and/or Services, please consult:

Website
www.sunatrafic.com.au/termsandconditions/

1. Acceptance

By using SUNA Products and/or Services, you will be deemed to have accepted and agreed to be bound by the terms and conditions fully detailed at:

Website
www.sunatrafic.com.au/termsandconditions/

2. Intellectual Property

SUNA Products and/or Services are for your personal use. You may not record, or retransmit the content, nor use the content in association with any other traffic information or route guidance service or device not approved by Intelomatics. You obtain no right of ownership in any Intellectual Property Rights (including copyright) in the data that is used to provide SUNA Products and/or Services.

3. Appropriate Use

Customer Information

SUNA Products and/or Services are intended as an aid to personal motoring and travel planning, and do not provide comprehensive or accurate information on all occasions. On occasions, you may experience additional delay as a result of using SUNA Products and/or Services. You acknowledge that it is not intended, or suitable, for use in applications where time of arrival or driving directions may impact the safety of the public or yourself.

4. Use of SUNA Products and Services while driving

You, and other authorized drivers of the vehicle in which SUNA Products and/or Services are available or installed and active, remain at all times responsible for observing all relevant laws and codes of safe driving. In particular, you agree to only actively operate SUNA Products and/or Services when the Vehicle is at a complete stop and it is safe to do so.

5. Service Continuity and Reception of the SUNA Traffic Channel

We will use reasonable endeavors to provide the SUNA Traffic Channel 24 hours a day, 365 days a year. The SUNA Traffic Channel may occasionally be unavailable for technical reasons or for planned maintenance. We will try to perform maintenance at times when congestion is light. We reserve the right to withdraw SUNA Products and/or Services at any time.

Also, we cannot assure the uninterrupted reception of the SUNA Traffic Channel RDS-TMC signal at any particular location.

6. Limitation of Liability

Neither Intelematics (nor its suppliers or the manufacturer of your device (the **"Suppliers"**)) shall be liable to you or to any third party for any damages either direct, indirect, incidental, consequential or otherwise arising out of the use of or inability to use SUNA Products and/or

Services even if Intelematics or a Supplier has been advised of the possibility of such damages. You also acknowledge that neither Intelematics nor any Supplier guarantees nor make any warranties that relate to the availability, accuracy or completeness of SUNA Products and/or Services, and to the extent which it is lawful to do so, both Intelematics and each Supplier excludes any warranties which might otherwise be implied by any State or Federal legislation in relation to SUNA Products and/or Services.

7. Please Note

Great care has been taken in preparing this manual. Constant product development may mean that some information is not entirely up-to-date. The information in this document is subject to change without notice.

EMISSION LAW



WARNING: Do not remove or alter the original equipment floor covering or insulation between it and the metal floor of the vehicle. The floor covering and insulation protect occupants of the vehicle from the engine and exhaust system heat and noise. On vehicles with no original equipment floor covering insulation, do not carry passengers in a manner that permits prolonged skin contact with the metal floor. Failure to follow these instructions may result in fire or personal injury.

U.S. federal laws and certain state laws prohibit removing or rendering inoperative emission control system components. Similar federal or provincial laws may apply in Canada. We do not approve of any vehicle modification without first determining applicable laws.

Customer Information



Tampering with emissions control systems including related sensors or the Diesel

Exhaust Fluid system can result in reduced engine power and the illumination of the service engine soon light.

Tampering With a Noise Control System

Federal laws prohibit the following acts:

- Removal or rendering inoperative by any person other than for purposes of maintenance.
- Repair or replacement of any device or element of the design incorporated into a new vehicle for the purpose of noise control prior to its sale or delivery to the ultimate purchaser or while it is in use.
- The use of the vehicle after any person removes or renders inoperative any device or element of the design.

The U.S. Environmental Protection Agency may presume to constitute tampering as follows:

- Removal of hood blanket, fender apron absorbers, fender apron barriers, underbody noise shields or acoustically absorptive material.
- Tampering or rendering inoperative the engine speed governor, to allow engine speed to exceed manufacturer specifications.

If the engine does not start, runs rough, experiences a decrease in engine performance, experiences excess fuel consumption or produces excessive exhaust smoke, check for the following:

- A plugged or disconnected air inlet system hose.
- A plugged engine air filter element.
- Water in the fuel filter and water separator.

- A clogged fuel filter.
- Contaminated fuel.
- Air in the fuel system, due to loose connections.
- An open or pinched sensor hose.
- Incorrect engine oil level.
- Incorrect fuel for climatic conditions.
- Incorrect engine oil viscosity for climactic conditions.

Note: *Some vehicles have a lifetime fuel filter that is integrated with the fuel tank. Regular maintenance or replacement is not needed.*

Note: *If these checks do not help you correct the concern, have your vehicle checked as soon as possible.*

Noise Emissions Warranty, Prohibited Tampering Acts and Maintenance

On January 1, 1978, Federal regulation became effective governing the noise emission on trucks over 10,000 lb (4,536 kg) Gross Vehicle Weight Rating (GVWR). The preceding statements concerning prohibited tampering acts and maintenance, and the noise warranty found in the Warranty Guide, are applicable to complete chassis cabs over 10,000 lb (4,536 kg) GVWR.

EXPORT UNIQUE OPTIONS

For your particular global region, your vehicle may be equipped with features and options that are different from the features and options that are described in this Owner's Manual. A market unique supplement may be supplied that complements this book. By referring to the market unique supplement, if provided, you can properly identify those features, recommendations and specifications that are unique to your vehicle. This Owner's

Customer Information

Manual is written primarily for the U.S. and Canadian markets. Features or equipment listed as standard may be different on units built for export. **Refer to this Owner's Manual for all other required information and warnings.**

WARRANTY INFORMATION

The following warranties may apply to your vehicle:

- New vehicle limited warranties.
- Emissions warranties, if applicable. (Note: Fully-electric vehicles are not eligible for emissions warranties.)
- Other warranties, if applicable.

Detailed warranty information specific to your vehicle can be found in the Warranty Guide at www.owner.ford.com.

The following California Warranty Statement, required by California regulations, applies to vehicles certified to California emissions standards and registered in a state that requires California emissions warranty. If applicable, additional California Emissions Warranties can be found in the Warranty Guide at www.owner.ford.com.

CALIFORNIA EMISSION CONTROL WARRANTY STATEMENT

YOUR WARRANTY RIGHTS AND OBLIGATIONS

The California Air Resources Board and Ford Motor Company are pleased to explain the emission control system warranty on your (year) vehicle. In California, new motor vehicles must be designated, built and equipped to meet

the State's stringent anti-smog standards. Ford Motor Company must warrant the emission control system on your vehicle for the periods of time listed below provided there has been no abuse, neglect or improper maintenance of your vehicle.

Your emission control system may include parts such as the carburetor or fuel-injection system, the ignition system, catalytic converter and engine computer. Also included may be hoses, belts, connectors and other emission-related assemblies. Where a warrantable condition exists, Ford Motor Company will repair your vehicle at no cost to you including diagnosis, parts and labor.

MANUFACTURER'S WARRANTY COVERAGE:

(For 1990 and subsequent model passenger cars, light-duty trucks, and medium-duty vehicles.)

- For 3 years or 50,000 miles (whichever occurs first);

1) If your vehicle fails a Smog Check inspection, all necessary repairs and adjustments will be made by Ford Motor Company to ensure that your emission control system PERFORMANCE WARRANTY.

2) If any emission-related part on your vehicle is defective, the part will be repaired or replaced by Ford Motor Company. This is your short-term emission control system DEFECTS WARRANTY.

- For 7 years or 70,000 miles (whichever occurs first);

1) If an emission-related part listed in this warranty booklet specially noted with coverage for 7 years or 70,000 miles is defective, the part will be repaired or replaced by Ford Motor Company. This is your long-term emission control system DEFECTS WARRANTY.

Customer Information

OWNER'S WARRANTY RESPONSIBILITIES:

- As the vehicle owner, you are responsible for the performance of the required maintenance listed in your owner's manual. Ford Motor Company recommends that you retain all receipts covering maintenance on your vehicle, but Ford Motor Company cannot deny warranty solely for the lack of receipts or for your failure to ensure the performance of all scheduled maintenance.

- You are responsible for presenting your vehicle to a Ford or Lincoln dealer as soon as a problem exists. The warranty repairs should be completed in a reasonable amount of time, not to exceed 30 days.

- As the vehicle owner, you should also be aware that Ford Motor Company may deny you warranty coverage if your vehicle or a part has failed due to abuse, neglect, improper maintenance or unapproved modifications.

If you have any questions regarding your warranty rights and responsibilities, you should contact Ford Customer Service at 1-800-392-3673 or the California Air Resource Board at 9528 Telstar Avenue, El Monte, CA 91731.

New Vehicle Limited Warranty

Your vehicle comes with a New Vehicle Limited Warranty. The express warranties of the New Vehicle Limited Warranty are in substitution for and exclude all other liabilities of any kind whether arising under statute, in tort, by implication of law or otherwise including, to the full extent as may be allowed by law, liability for any other representations respecting the vehicle, statutory warranties or implied warranties or conditions as to its merchantability or fitness.

Download a free electronic copy or order one free printed copy of the most up-to-date Warranty Guide by visiting the Owner Manuals section of owner.ford.com (United States).

For Canada, visit ford.ca/warranty.

For Limo/Livery/Hearse vehicles: View and download your Warranty Guide by visiting the Warranty Information section of the Fleet website, fleet.ford.com/limo (United States only).

Appendices

ELECTROMAGNETIC COMPATIBILITY



WARNING: Do not place objects or mount equipment on or near the airbag cover, on the side of the front or rear seatbacks, or in areas that may come into contact with a deploying airbag. Failure to follow these instructions may increase the risk of personal injury in the event of a crash.



WARNING: Keep antenna and power cables at least 4 in (10 cm) from any electronic modules and airbags.

Note: We test and certify your vehicle to meet electromagnetic compatibility legislation. It is your responsibility to make sure that any equipment an authorized dealer installs on your vehicle complies with applicable local legislation and other requirements. Installation of some aftermarket electronic devices could degrade the performance of vehicle functions, which use radio frequency signals such as broadcast radio receiver, tire pressure monitoring system, push button start, **Bluetooth®** connectivity or satellite navigation.

Note: Any radio frequency transmitter equipment in your vehicle, such as, cellular telephones and amateur radio transmitters, must keep to the parameters in the following illustrations and table. We do not provide any other special provisions or conditions for installations or use.

Car

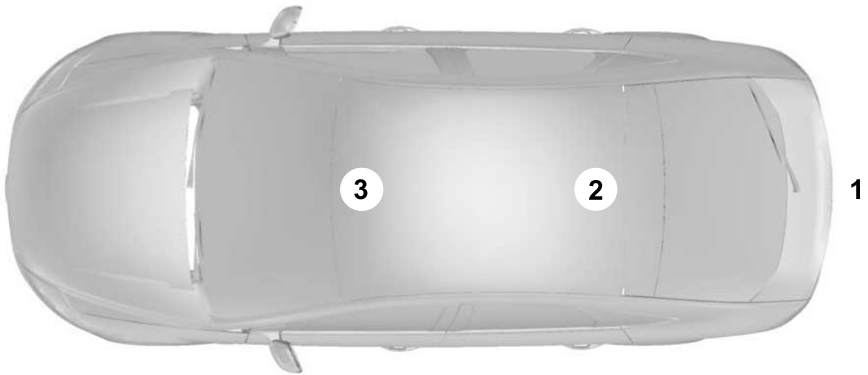

Appendices

Van

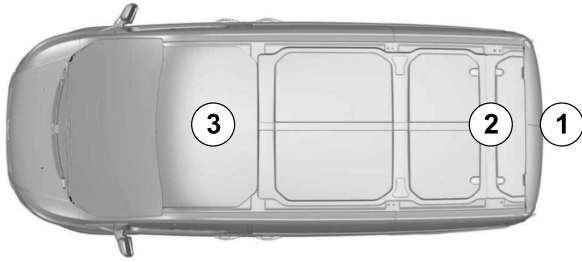

Truck

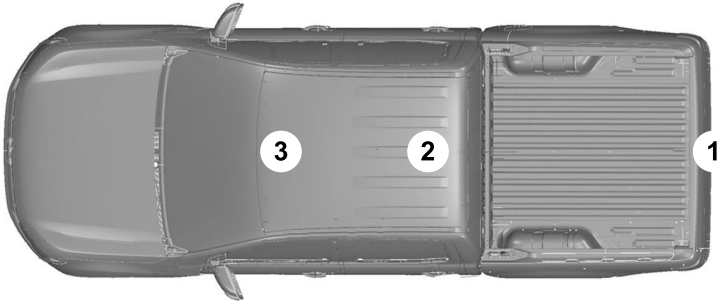

Appendices

Frequency Band MHz	Maximum Output Power Watt (Peak RMS)	Antenna Positions
1-30	50	1
50-54	50	2, 3
68-88	50	2, 3
142-176	50	2, 3
380-512	50	2, 3
806-870	10	2, 3

Index

1

12V Battery.....	380
12V Battery Precautions.....	380
Battery Management System	
Limitations.....	381
Changing the 12V Battery.....	381
Charging the 12V Battery.....	384
How Does the Battery Management	
System Work.....	381
Recycling and Disposing of the 12V	
Battery.....	384
Resetting the Battery Sensor.....	384
What Is the Battery Management	
System.....	381
12V Battery – Troubleshooting - Battery	
Electric Vehicle.....	385
12V Battery – Information Messages.....	386
12V Battery – Warning Lamps.....	385
12V Battery – Troubleshooting -	
Gasoline.....	384
12V Battery – Information Messages.....	384
12V Battery – Warning Lamps.....	384
180 Degree Camera.....	256
180 Degree Camera Precautions.....	256

3

360 Degree Camera.....	257
360 Degree Camera Guide Lines.....	258
360 Degree Camera Limitations.....	257
360 Degree Camera Precautions.....	257

9

911 Assist.....	71
-----------------	----

A

A/C

See: Climate Control - Vehicles With:	
Automatic Temperature Control.....	133
See: Climate Control - Vehicles With: Manual	
Temperature Control.....	139
About This Publication.....	19
ABS	
See: Brakes.....	225
Accessing Navigation.....	514

Accessing the Passive Key Backup	
Position.....	176
Accessing the Trip Computer.....	129
Accessories.....	521
AC Charging.....	202
Connecting the Charger.....	202
Stopping Charging.....	205
Active Park Assist.....	260
Active Park Assist – Troubleshooting.....	261
Active Park Assist Precautions.....	260
Active Park Assist –	
Troubleshooting.....	261
Active Park Assist – Frequently Asked	
Questions.....	261
Active Park Assist – Information	
Messages.....	261
Adaptive Cruise Control.....	265
Adaptive Cruise Control –	
Troubleshooting.....	272
Intelligent Adaptive Cruise Control.....	271
Adaptive Cruise Control Automatic	
Cancellation.....	268
Adaptive Cruise Control Indicators.....	270
Adaptive Cruise Control	
Limitations.....	266
Adaptive Cruise Control	
Precautions.....	265
Adaptive Cruise Control –	
Troubleshooting.....	272
Adaptive Cruise Control – Information	
Messages.....	272
Adjusting the Exterior Mirrors.....	115
Adjusting the Headlamps.....	386
Adjusting the Instrument Panel Lighting	
Brightness.....	110
Adjusting the Integrated Trailer Brake	
Controller Mode.....	325
Adjusting the Map.....	514
Changing the Format of the Map.....	514
Zooming the Map In and Out.....	514
Adjusting the Seatbelt Height.....	54
Adjusting the Seatbelt Length.....	54
Adjusting the Seatbelts During	
Pregnancy.....	53
Adjusting the Sound Settings - Vehicles	
With: SYNC 3 Lite, Vehicles Without:	
SYNC.....	479

Index

Adjusting the Sound Settings - Vehicles With: SYNC 4.....	479
Adjusting the Speed Limit Tolerance.....	281
Adjusting the Steering Wheel.....	100
Adjusting the Volume.....	478
Aid Mode.....	285
How Does Aid Mode Work.....	285
What Is Aid Mode.....	285
Airbag Precautions.....	62
Airbags.....	60
Air Conditioning	
See: Climate Control - Vehicles With: Automatic Temperature Control.....	133
See: Climate Control - Vehicles With: Manual Temperature Control.....	139
Air Conditioning System Capacity and Specification - Battery Electric Vehicle, Vehicles With: Standard Range Battery.....	466
Air Conditioning System Capacity and Specification - Gasoline.....	465
Air Conditioning System Capacity and Specification - Vehicles Built From: 03/2024, Battery Electric Vehicle, Vehicles With: Extended Range Battery.....	467
Alert and Aid Mode.....	286
How Does Alert and Aid Mode Work.....	286
What Is Alert and Aid Mode.....	286
Alert Mode.....	285
Adjusting the Steering Wheel Vibration Intensity.....	285
How Does Alert Mode Work.....	285
What Is Alert Mode.....	285
Alexa Built-In.....	505
Alexa Built-In Requirements.....	505
Alexa Built-In Settings.....	505
All-Wheel Drive.....	224
All-Wheel Drive – Troubleshooting.....	224
All-Wheel Drive Limitations.....	224
All-Wheel Drive Precautions.....	224
All-Wheel Drive – Troubleshooting.....	224
All-Wheel Drive – Information Messages.....	224
AM/FM Radio.....	480
AM/FM Radio Limitations.....	480
Selecting an AM/FM Radio Station.....	480
Anti-Lock Braking System.....	225
Anti-Lock Braking System Limitations.....	225
Anti-Theft Alarm System.....	97
Arming the Anti-Theft Alarm System.....	97
Disarming the Anti-Theft Alarm System.....	98
How Does the Anti-Theft Alarm System Work.....	97
What Is the Anti-Theft Alarm System.....	97
What Is the Battery Backup Alarm.....	97
Appendices.....	606
Applying the Electric Parking Brake.....	231
Applying the Electric Parking Brake in an Emergency.....	231
Applying the Parking Brake.....	228
App Precautions.....	512
App Requirements.....	512
Apps.....	512
Audio System.....	477
AM/FM Radio.....	480
Digital Radio.....	481
Satellite Radio.....	483
Audio System Precautions.....	477
Auto-Dimming Interior Mirror.....	114
Auto-Dimming Interior Mirror Limitations.....	114
What Is the Auto-Dimming Interior Mirror.....	114
Auto Hold.....	239
Auto Hold Indicators.....	239
Autolamps.....	105
Autolamp Settings.....	105
What Are Autolamps.....	105
Autolock.....	89
Autolock Requirements.....	89
What Is Autolock.....	89
Automatically Releasing the Electric Parking Brake.....	231
Automatic Crash Shutoff.....	342
Automatic Crash Shutoff Precautions.....	343
Re-Enabling Your Vehicle.....	343
What Is Automatic Crash Shutoff.....	342
Automatic Emergency Braking.....	304
Switching Automatic Emergency Braking On and Off.....	304

Index

What Is Automatic Emergency Braking.....	304
Automatic Engine Stop - Vehicles With: Push Button Start.....	175
How Does Automatic Engine Stop Work.....	175
Overriding Automatic Engine Stop.....	176
Switching Automatic Engine Stop On and Off.....	175
What Is Automatic Engine Stop.....	175
Automatic High Beam Control.....	107
Automatic High Beam Control Indicators.....	109
Automatic High Beam Control Limitations.....	108
Automatic High Beam Control Precautions.....	108
Automatic High Beam Control Requirements.....	108
How Does Automatic High Beam Control Work.....	107
Overriding Automatic High Beam Control.....	109
Switching Automatic High Beam Control On and Off.....	109
Automatic High Beam Control – Troubleshooting.....	109
Automatic High Beam Control – Information Messages.....	109
Automatic Locking Mode.....	52
Disengaging Automatic Locking Mode.....	53
Engaging Automatic Locking Mode.....	53
What Is Automatic Locking Mode.....	52
When to Use Automatic Locking Mode.....	53
Automatic Return to Park (P) - 1-Speed Automatic Transmission.....	222
Automatic Return to Park (P) Limitations.....	222
How Does Automatic Return to Park (P) Work.....	222
Automatic Transmission Audible Warnings - 10-Speed Automatic Transmission.....	220
Automatic Transmission Audible Warnings - 1-Speed Automatic Transmission.....	220
Automatic Transmission.....	216
Automatic Return to Park (P) - 1-Speed Automatic Transmission.....	222
Automatic Transmission Positions.....	216
Automatic Transmission – Troubleshooting.....	223
Manually Shifting Gears - 10-Speed Automatic Transmission.....	221
Temporary Neutral Mode - 1-Speed Automatic Transmission.....	221
Automatic Transmission Position Indicators - 10-Speed Automatic Transmission.....	218
Automatic Transmission Position Indicators - 1-Speed Automatic Transmission.....	217
Automatic Transmission Positions.....	216
Drive (D).....	217
Low (L).....	217
Manual (M).....	217
Neutral (N).....	216
Park (P).....	216
Reverse (R).....	216
Automatic Transmission Precautions.....	216
Automatic Transmission – Troubleshooting.....	223
Automatic Transmission – Information Messages.....	223
Auto Mode.....	135
Auto Mode Indicators.....	136
Switching Auto Mode On and Off.....	135
Autorelock.....	89
How Does Autorelock Work.....	89
Autounlock.....	88
Autounlock Requirements.....	89
Switching Autounlock On and Off.....	89
What Is Autounlock.....	88
Autowipers.....	101
Adjusting the Sensitivity of the Rain Sensor.....	101
Autowipers Settings.....	101
What Are Autowipers.....	101
AWD See: All-Wheel Drive.....	224

Index

B

Beginning a Voice Interaction.....	503
Blind Spot Assist - Vehicles With: Blind Spot Information System, Vehicles Without: Trailer Tow.....	286
Blind Spot Assist Indicators.....	287
Blind Spot Assist – Information Messages.....	288
Blind Spot Assist Limitations.....	287
How Does Blind Spot Assist Work.....	286
What Is Blind Spot Assist.....	286
Blind Spot Assist with Trailer Coverage – Vehicles With: Blind Spot Information System/Trailer Tow.....	288
Blind Spot Assist with Trailer Coverage Indicators.....	290
Blind Spot Assist with Trailer Coverage – Information Messages.....	291
Blind Spot Assist with Trailer Coverage Limitations.....	289
How Does Blind Spot Assist with Trailer Coverage Work.....	288
What Is Blind Spot Assist with Trailer Coverage.....	288
Blind Spot Information System.....	292
Blind Spot Information System – Troubleshooting.....	295
Blind Spot Information System With Trailer Coverage.....	294
Blind Spot Information System Indicators.....	295
Blind Spot Information System Limitations.....	292
Blind Spot Information System Precautions.....	292
Blind Spot Information System Requirements.....	293
Blind Spot Information System – Troubleshooting.....	295
Blind Spot Information System – Information Messages.....	296
Blind Spot Information System – Warning Lamps.....	295
Blind Spot Information System With Trailer Coverage.....	294
Blind Spot Information System With Trailer Coverage Limitations.....	294

How Does Blind Spot Information System With Trailer Coverage Work.....	294
Selecting a Trailer.....	295
Setting a Trailer Length.....	295
Switching Blind Spot Information System With Trailer Coverage On and Off.....	294
What Is Blind Spot Information System with Trailer Coverage.....	294
Bluetooth®.....	511
Body Control Module Fuse Box.....	359
Accessing the Body Control Module Fuse Box.....	359
Identifying the Fuses in the Body Control Module Fuse Box.....	360
Bonnet Lock	
See: Opening and Closing the Hood.....	365
Booster Seats.....	48
Bottle Holders.....	169
Bottle Holder Precautions.....	169
Locating the Bottle Holders.....	169
Brake Fluid Specification.....	226
Brake Over Accelerator.....	225
Brake Precautions.....	225
Brakes.....	225
Anti-Lock Braking System.....	225
Brakes – Troubleshooting.....	226
Brakes – Troubleshooting.....	226
Brakes – Frequently Asked Questions.....	227
Brakes – Warning Lamps.....	226
Breaking-In.....	331

C

Calculating Payload.....	312
Calculating the Load Limit.....	312
Canceling the Set Speed.....	263
Canceling the Set Speed Limit.....	278
Capacities and Specifications.....	452
Cargo Lamps - Van.....	111
Switching the Cargo Lamps On and Off.....	111
Catalytic Converter.....	190
Catalytic Converter – Troubleshooting.....	190
Catalytic Converter Precautions.....	190

Index

Catalytic Converter – Troubleshooting.....	190
Catalytic Converter – Warning Lamps.....	190
Center Display Limitations.....	501
Center Display Overview.....	501
Center Display Precautions.....	501
Changing a Flat Tire - Battery Electric Vehicle.....	444
Changing a Flat Tire - Gasoline.....	434
Changing a Road Wheel.....	434
Changing the Remote Control Battery - Vehicles With: Keyed Ignition.....	74
Changing the Remote Control Battery - Vehicles With: Push Button Start.....	75
Changing the Set Speed Limit.....	278
Changing the Vehicle Wi-Fi Hotspot Name or Password - Vehicles With: SYNC 4.....	475
Charge Coupler Manual Release.....	205
Charge Port Indicators.....	201
Charging a Device.....	159
Charging Equipment.....	193
Charging Your Vehicle.....	193
AC Charging.....	202
Charging Your Vehicle – Troubleshooting.....	214
DC Charging.....	206
Charging Your Vehicle Hints.....	213
Charging Your Vehicle Precautions.....	193
Charging Your Vehicle – Troubleshooting.....	214
Charging Your Vehicle – Frequently Asked Questions.....	215
Charging Your Vehicle – Information Messages.....	214
Charging Your Vehicle – Warning Lamps.....	214
Checking MyKey System Status.....	81
Checking the Brake Fluid.....	225
Checking the Seatbelts.....	57
Checking the Tire Pressures.....	421
Checking the Wiper Blades.....	102
Children and Airbags.....	67
Child Restraints.....	36
Child Restraint Position Information.....	36
Child Restraints Recommendation.....	37
Child Safety.....	34
Child Restraints.....	36
Installing Child Restraints.....	38
Child Safety Locks.....	50
Child Safety Precautions.....	34
Cigar Lighter.....	168
Cigar Lighter Precautions.....	168
Cleaning the Exterior.....	403
Cleaning Camera Lenses and Sensors.....	404
Cleaning Chrome, Aluminium or Stainless Steel.....	403
Cleaning Headlamps and Rear Lamps.....	403
Cleaning Stripes or Graphics.....	404
Cleaning the Engine Compartment.....	404
Cleaning the Exterior Precautions.....	403
Cleaning the Underbody.....	404
Cleaning Wheels.....	403
Cleaning Windows and Wiper Blades.....	403
Cleaning the Interior.....	405
Cleaning Carpets and Floor Mats.....	406
Cleaning Displays and Screens.....	405
Cleaning Fabric.....	405
Cleaning Leather.....	405
Cleaning Plastic.....	405
Cleaning Seatbelts.....	406
Cleaning Storage Compartments.....	406
Cleaning the Instrument Panel.....	405
Cleaning Vinyl.....	406
Clearing All MyKeys.....	81
Climate Control.....	133
Auto Mode.....	135
Climate Control Hints - Battery Electric Vehicle.....	137
Climate Control Hints.....	141
Climate Control Hints - Gasoline.....	136
Closing the Sliding Door.....	92
Closing the Sliding Door From Inside Your Vehicle.....	92
Closing the Sliding Door From Outside Your Vehicle.....	92
Cold Weather Precautions.....	330
Configuring the Trip Computer.....	129
Connected Navigation.....	514

Index

Connected Vehicle.....	471	Cooling System Capacity and Specification - 3.5L Duratec.....	460
Connected Vehicle – Troubleshooting.....	472	Cooling System Capacity and Specification - 3.5L Ecoboost™.....	461
Connecting the Vehicle to a Mobile Network.....	471	Cooling System Capacity and Specification - Battery Electric Vehicle.....	461
Connected Vehicle Data.....	27	Crash and Breakdown Information.....	335
Connected Vehicle Limitations.....	471	Automatic Crash Shutoff.....	342
Connected Vehicle Requirements.....	471	Fail-Safe Cooling - 3.5L Duratec/3.5L Ecoboost™.....	344
Connected Vehicle – Troubleshooting.....	472	Jump Starting the Vehicle.....	339
Connected Vehicle – Frequently Asked Questions.....	472	Post-Crash Alert System.....	342
Connecting a Bluetooth® Device.....	511	Recovery Towing.....	343
Connecting a Trailer.....	316	Crash Sensors and Airbag Indicator.....	68
Connecting a Trailer – Troubleshooting.....	318	Creating a MyKey - Vehicles With: Keyed Ignition.....	80
Connecting a Trailer Precautions.....	316	Creating a MyKey - Vehicles With: Push Button Start.....	80
Connecting a Trailer – Troubleshooting.....	318	Creating a Vehicle Wi-Fi Hotspot - Vehicles With: SYNC 4.....	475
Connecting a Trailer – Information Messages.....	318	Cross Traffic Alert.....	297
Connecting the Vehicle to a Mobile Network.....	471	Cross Traffic Alert – Troubleshooting.....	299
Connecting FordPass to the Modem.....	472	Cross Traffic Alert With Trailer Coverage.....	298
Enabling and Disabling the Modem.....	471	Cross Traffic Alert Indicators.....	299
What Is the Modem.....	471	Cross Traffic Alert Limitations.....	297
Connecting the Vehicle to a Wi-Fi Network - Vehicles With: SYNC 3 Lite.....	472	Cross Traffic Alert Precautions.....	297
Connecting the Vehicle to a Wi-Fi Network - Vehicles With: SYNC 4.....	472	Cross Traffic Alert – Troubleshooting.....	299
Connecting Your Phone.....	507	Cross Traffic Alert – Information Messages.....	299
Contacting Us.....	17	Cross Traffic Alert – Warning Lamps.....	299
Coolant - Battery Electric Vehicle.....	377	Cross Traffic Alert With Trailer Coverage.....	298
Adding Coolant.....	377	Cross Traffic Alert With Trailer Coverage Limitations.....	298
Changing the Coolant.....	378	What Is Cross Traffic Alert With Trailer Coverage.....	298
Checking the Coolant Level.....	377	Cruise Control.....	263
Coolant – Information Messages.....	380	Cruise Control Indicators.....	264
Coolant – Warning Lamps.....	379	Customer Information.....	538
Managing the Coolant Temperature.....	379	Radio Frequency Certification Labels.....	541
Coolant - Gasoline.....	373	Customizing the Instrument Cluster Display.....	125
Adding Coolant.....	374		
Changing the Coolant.....	375		
Checking the Coolant Level.....	373		
Coolant – Information Messages.....	376		
Coolant – Warning Lamps.....	376		
Managing the Coolant Temperature.....	375		

Index

D

Data Privacy - Battery Electric Vehicle.....	24
Data Privacy.....	23
Data Privacy - Gasoline.....	23
DC Charging.....	206
Connecting the Charger.....	206
Stopping Charging.....	208
Department of Transportation Uniform Tire Quality Grades.....	410
Digital Interior Mirror.....	114
Digital Interior Mirror Limitations.....	114
Digital Interior Mirror Settings.....	114
Switching Between Normal View and Camera View.....	114
What Is the Digital Interior Mirror.....	114
Digital Radio.....	481
Digital Radio Indicators.....	482
Digital Radio Limitations.....	482
How Does Digital Radio Work.....	482
What Is Digital Radio.....	481
Directing the Flow of Air.....	135
Disposing of Airbags.....	69
Distance Alert.....	304
Adjusting the Sensitivity of Distance Alert.....	304
What Is Distance Alert.....	304
Distance Indication.....	303
Distance Indication Indicator.....	303
Switching Distance Indication On and Off.....	303
What Is Distance Indication.....	303
Doors and Locks Audible Warnings.....	89
Doors and Locks.....	85
Autolock.....	89
Autorelock.....	89
Autounlock.....	88
Doors and Locks – Troubleshooting.....	89
Operating the Doors From Inside Your Vehicle.....	86
Operating the Doors From Outside Your Vehicle.....	85
Doors and Locks – Troubleshooting.....	89
Doors and Locks – Information Messages.....	90
Doors and Locks – Warning Lamps.....	89
Drive Belt Routing - Gasoline, Vehicles With: Dual Generators.....	402
Drive Belt Routing - Gasoline, Vehicles With: Single Generator.....	402
Drive Mode Control.....	275
Drive Mode Control – Troubleshooting.....	276
Drive Modes - Battery Electric Vehicle.....	276
Drive Modes - Gasoline.....	275
Drive Mode Control – Troubleshooting.....	276
Drive Mode Control – Information Messages.....	276
Drive Modes - Battery Electric Vehicle.....	276
Eco.....	276
Normal.....	276
Slippery.....	276
Drive Modes - Gasoline.....	275
Eco.....	275
Normal.....	275
Slippery.....	275
Tow/Haul.....	275
Trail.....	275
Driver Alert.....	308
Driver Alert – Troubleshooting.....	309
Driver Alert Precautions.....	308
Driver Alert – Troubleshooting.....	309
Driver Alert – Information Messages.....	309
Driver Identification.....	517
Driver Identification – Troubleshooting.....	517
Driver Identification – Troubleshooting.....	517
Driver Identification – Information Messages.....	517
Driving Economically.....	331
Driving Hints.....	329
Driving in Special Conditions.....	331
Electric Vehicle.....	333
Off-Road Driving - Vehicles With: Trail Package.....	329
Driving in Special Conditions.....	331
Driving In Sand.....	332
Driving on Hilly or Sloping Terrain.....	332
Driving Through Mud and Water.....	331
Driving on Snow and Ice.....	330

Index

Driving Through Shallow Water - Battery Electric Vehicle.....	333
Driving Through Shallow Water - Gasoline.....	332
Drowsiness Monitor	
See: Driver Alert.....	308

E

Eco Coach.....	277
Electric Parking Brake Audible Warning.....	232
Electric Parking Brake.....	231
Electric Parking Brake – Troubleshooting.....	232
Electric Parking Brake – Troubleshooting.....	232
Electric Parking Brake – Information Messages.....	232
Electric Parking Brake – Warning Lamps.....	232
Electric Power Steering.....	245
Electric Power Steering Precautions.....	245
Electric Vehicle.....	333
Maximizing Your Driving Range.....	333
Electromagnetic Compatibility.....	606
Emergency Call Limitations.....	72
Emergency Call Requirements.....	72
Emergency Call System Data - Battery Electric Vehicle.....	29
Emergency Call System Data - Gasoline.....	28
Emergency Equipment.....	347
Emergency Towing - Battery Electric Vehicle.....	346
Emission Law.....	602
Enabling Apps on an Android Device.....	512
Enabling Apps on an iOS Device.....	512
Enabling Remote Start.....	130
End User License Agreement.....	577
Engine Air Filter - Gasoline.....	372
Changing the Engine Air Filter.....	372
Engine Air Filter – Information Messages.....	373
Engine Block Heater.....	173
Engine Block Heater Precautions.....	173

How Does the Engine Block Heater Work.....	173
Using the Engine Block Heater.....	174
Engine Coolant Temperature Gauge - Gasoline.....	120
Engine Cooling Fan - Gasoline.....	373
Engine Oil Capacity and Specification - 3.5L Duratec.....	457
Engine Oil Capacity and Specification - 3.5L Ecoboost™.....	458
Engine Oil - Gasoline.....	370
Adding Engine Oil.....	370
Checking the Engine Oil Level.....	370
Engine Oil Dipstick Overview.....	370
Engine Oil – Information Messages.....	371
Intelligent Oil Life Monitor.....	371
Resetting the Intelligent Oil Life Monitor.....	371
Engine Specifications - 3.5L Duratec.....	452
Engine Specifications - 3.5L Ecoboost™.....	453
Entering a Parking Space.....	261
Environment.....	30
Event Data.....	26
Exiting a Parking Space.....	261
Export Unique Options.....	603
Extending the Remote Start Duration.....	131
Exterior Bulbs.....	388
Changing a Clearance Lamp Bulb.....	394
Changing a Front Parking Lamp Bulb.....	392
Changing a Front Side Marker Lamp Bulb.....	394
Changing a Front Turn Signal Lamp Bulb.....	393
Changing a Headlamp Bulb.....	391
Changing a License Plate Lamp Bulb.....	398
Changing a Mirror Turn Signal Lamp Bulb.....	395
Changing a Rear Lamp Bulb.....	395
Changing a Reversing Lamp Bulb.....	397
Changing a Stoplamp Bulb.....	396
Exterior Bulb Specification Chart.....	388
Removing a Headlamp Assembly.....	390
Removing a Rear Lamp Assembly.....	390

Index

Exterior Lamps.....	106	Front Parking Aid.....	248
Exterior Lamps On Audible Warning.....	107	Front Parking Aid Audible Warnings.....	248
How Do Cornering Lamps Work.....	106	Front Parking Aid Limitations.....	248
Switching the Daytime Running Lamps On and Off.....	106	Locating the Front Parking Aid Sensors.....	248
Using the Front Fog Lamps.....	107	What is the Front Parking Aid.....	248
Using the Turn Signal Lamps.....	106	Front Seat Precautions.....	144
Exterior Lighting Control.....	104	Front Seats.....	144
Exterior Lighting.....	104	Manual Seats.....	145
Autolamps.....	105	Power Seats.....	148
Automatic High Beam Control.....	107	Fuel and Refueling.....	183
Automatic High Beam Control – Troubleshooting.....	109	Fuel and Refueling – Troubleshooting.....	189
Exterior Lamps.....	106	Fuel Quality.....	184
Headlamps.....	104	Refueling.....	187
Headlamps – Troubleshooting.....	105	Running Out of Fuel.....	186
Exterior Mirrors.....	115	Fuel and Refueling Precautions.....	183
F		Fuel and Refueling – Troubleshooting.....	189
Fail-Safe Cooling - 3.5L Duratec/3.5L Ecoboost™.....	344	Fuel and Refueling – Information Messages.....	189
Driving When Fail-Safe Mode Is Activated.....	345	Fuel and Refueling – Warning Lamps.....	189
Fail-Safe Cooling Indicators.....	345	Fuel Economy Display.....	126
How Does Fail-Safe Cooling Work.....	344	Fuel Filter - Gasoline.....	401
What Is Fail-Safe Cooling.....	344	Fuel Gauge - Gasoline.....	119
Fan		Fuel Gauge Limitations.....	119
See: Engine Cooling Fan - Gasoline.....	373	Locating the Fuel Filler Door.....	119
Fastening and Unfastening the Seatbelts.....	51	What Is Distance to Empty.....	119
Flat Tire		What Is the Fuel Gauge.....	119
See: Changing a Flat Tire - Battery Electric Vehicle.....	444	What Is the Low Fuel Reminder.....	119
See: Changing a Flat Tire - Gasoline.....	434	Fuel Quality.....	184
Floor Mats.....	334	Selecting the Correct Fuel.....	184
Folding the Exterior Mirrors - Vehicles With: Manual Fold Exterior Mirrors.....	115	Switching Between E85 and Gasoline.....	185
Folding the Exterior Mirrors - Vehicles With: Power Fold Exterior Mirrors.....	115	Fuel Tank Capacity - 3.5L Duratec.....	189
Ford Protect.....	522	Fuel Tank Capacity - 3.5L Ecoboost™.....	189
Forward Collision Warning.....	303	Fuse Precautions.....	348
Adjusting the Sensitivity of Forward Collision Warning.....	303	Fuses.....	348
What is Forward Collision Warning.....	303	Body Control Module Fuse Box.....	359
Frequently Asked Questions.....	78	Fuses – Troubleshooting.....	364
		High Current Fuse Box.....	362
		Interior Fuse Box.....	353
		Under Hood Fuse Box.....	348
		Fuses – Troubleshooting.....	364
		Fuses – Frequently Asked Questions.....	364

Index

G	
General Maintenance Information - Battery Electric Vehicle.....	527
General Maintenance Information - Gasoline.....	524
Glossary of Tire Terminology.....	416
H	
Headlamp Adjusting See: Adjusting the Headlamps.....	386
Headlamps.....	104
Headlamp Indicators.....	104
Using the High Beam Headlamps.....	104
Headlamps – Troubleshooting.....	105
Headlamps – Frequently Asked Questions.....	105
Heated Seats.....	151
Heated Seat Precautions.....	151
Switching the Heated Seats On and Off.....	151
Heating See: Climate Control - Vehicles With: Automatic Temperature Control.....	133
See: Climate Control - Vehicles With: Manual Temperature Control.....	139
High Current Fuse Box.....	362
Accessing the High Current Fuse Box.....	362
Identifying the Fuses in the High Current Fuse Box.....	362
Locating the High Current Fuse Box.....	362
High Voltage Battery Gauge - Battery Electric Vehicle.....	120
High Voltage Battery.....	191
High Voltage Battery – Troubleshooting.....	192
High Voltage Battery Precautions.....	191
High Voltage Battery – Troubleshooting.....	192
High Voltage Battery – Warning Lamps.....	192
High Voltage Battery Vehicle Precautions - Battery Electric Vehicle.....	338
Hill Start Assist.....	238
Hill Start Assist – Troubleshooting.....	238
Hill Start Assist Precautions.....	238
Hill Start Assist – Troubleshooting.....	238
Hill Start Assist – Information Messages.....	238
Hood Lock See: Opening and Closing the Hood.....	365
How Does 911 Assist Work - Battery Electric Vehicle.....	71
How Does 911 Assist Work - Gasoline.....	71
How Does Adaptive Cruise Control Work.....	265
How Does All-Wheel Drive Work.....	224
How Does Auto Hold Work.....	239
How Does Blind Spot Information System Work.....	292
How Does Cross Traffic Alert Work.....	297
How Does Driver Alert Work.....	308
How Does Driver Identification Work.....	517
How Does Eco Coach Work.....	277
How Does Hill Start Assist Work.....	238
How Does Instantaneous Efficiency Level Work.....	277
How Does Pre-Collision Assist with Intersection Assist Work.....	301
How Does Pre-Collision Assist Work.....	300
How Does Reverse Brake Assist Work.....	234
How Does Speed Sign Recognition Work.....	306
How Does Stability Control Work.....	243
How Does the 180 Degree Camera Work.....	256
How Does the 360 Degree Camera Work.....	257
How Does the Intelligent Speed Limiter Work.....	280
How Does the Lane Keeping System Work.....	283
How Does the Personal Safety System Work.....	59
How Does the Rear Occupant Alert System Work.....	156
How Does the Safety Canopy™ Work.....	61
How Does the Speed Limiter Work.....	278

Index

How Does Traction Control Work.....	241
How Does Trailer Sway Control Work.....	328
How Does Trip Summary Work.....	277
How Do the Front Airbags Work.....	60
How Do the Side Airbags Work.....	60
I	
Icon Glossary See: Symbols Glossary.....	20
Icons See: Symbols Glossary.....	20
Identifying Fuse Types.....	364
Ignition Switch.....	170
Inflating the Tires.....	421
Information On Demand Screen.....	502
Information on the Tire Sidewall.....	411
Inspecting the Tire for Damage.....	423
Inspecting the Tire for Wear.....	422
Inspecting the Wheel Valve Stems.....	427
Installing Child Restraints.....	38
Attaching the Front Seat Tether Strap.....	46
Attaching the Rear Seat Tether Strap.....	46
Combining the Seatbelt and Lower Anchors for Attaching Child Restraints.....	42
Installing a Child Restraint in a Center Seat.....	41
Using Lower Anchors and Tethers for Children.....	40
Using Seatbelts.....	38
Using Tether Straps.....	42
Instrument Cluster Display.....	125
Personalized Settings.....	125
Instrument Cluster Display Main Menu.....	125
Instrument Cluster Indicators.....	123
Instrument Cluster.....	117
Fuel Gauge - Gasoline.....	119
Instrument Cluster Overview - Battery Electric Vehicle.....	118
Instrument Cluster Overview - Gasoline.....	117
Instrument Cluster Warning Lamps.....	120
Instrument Panel - Vehicles With: SYNC 3 Lite, Vehicles Without: SYNC.....	32
Instrument Panel - Vehicles With: SYNC 4.....	31
Integrated Trailer Brake Controller.....	324
Integrated Trailer Brake Controller - Troubleshooting.....	326
Integrated Trailer Brake Controller Precautions.....	324
Integrated Trailer Brake Controller - Troubleshooting.....	326
Integrated Trailer Brake Controller - Frequently Asked Questions.....	327
Integrated Trailer Brake Controller - Information Messages.....	326
Intelligent Adaptive Cruise Control.....	271
Adjusting the Set Speed Tolerance.....	272
How Does Intelligent Adaptive Cruise Control Work.....	271
Intelligent Adaptive Cruise Control Alerts.....	272
Intelligent Adaptive Cruise Control Indicators.....	272
Intelligent Adaptive Cruise Control Limitations.....	271
Intelligent Adaptive Cruise Control Precautions.....	271
Switching Intelligent Mode On and Off.....	271
Intelligent Speed Limiter Audible Warnings.....	282
Intelligent Speed Limiter Indicators.....	281
Intelligent Speed Limiter.....	280
Intelligent Speed Limiter - Troubleshooting.....	282
Intelligent Speed Limiter Precautions.....	280
Intelligent Speed Limiter - Troubleshooting.....	282
Intelligent Speed Limiter - Frequently Asked Questions.....	282
Intentionally Exceeding the Set Speed Limit.....	279
Interior Bulbs.....	399
Changing a Front Interior Lamp Bulb.....	400
Changing a Map Reading Lamp Bulb.....	400
Changing a Vanity Mirror Lamp Bulb.....	401
Interior Bulb Specification Chart.....	399

Index

Interior Fuse Box.....	353
Accessing the Interior Fuse Box.....	353
Identifying the Fuses in the Interior Fuse Box.....	354
Interior Lamp Function.....	110
Switching the Interior Lamp Function On and Off.....	110
What Is the Interior Lamp Function.....	110
Interior Lighting.....	110
Cargo Lamps - Van.....	111
Interior Lamp Function.....	110
Interior Mirror.....	114
Auto-Dimming Interior Mirror.....	114
Digital Interior Mirror.....	114
Interior Mirror Precautions.....	114
Introduction.....	19

J

Jump Starting the Vehicle.....	339
Jump Starting Precautions.....	339
Jump Starting the Vehicle.....	340
Preparing the Vehicle.....	340

K

Keyless Entry.....	93
Keyless Entry – Troubleshooting.....	94
Keyless Entry Keypad.....	95
Keyless Entry Keypad – Troubleshooting.....	96
Keyless Entry Keypad Limitations.....	95
Keyless Entry Keypad Master Access Code.....	95
Keyless Entry Keypad Personal Access Codes.....	95
Keyless Entry Keypad – Troubleshooting.....	96
Keyless Entry Keypad – Frequently Asked Questions.....	96
Keyless Entry Limitations.....	93
Keyless Entry Settings.....	93
Keyless Entry – Troubleshooting.....	94
Keyless Entry – Frequently Asked Questions.....	94
Keys and Remote Controls Audible Warnings - Vehicles With: Keyed Ignition.....	77

Keys and Remote Controls Audible Warnings - Vehicles With: Push Button Start.....	77
Keys and Remote Controls.....	73
Keys and Remote Controls – Troubleshooting.....	78
Keys and Remote Controls – Troubleshooting.....	78
Keys and Remote Controls – Information Messages.....	78

L

Lane Keeping System Indicators.....	286
Lane Keeping System.....	283
Aid Mode.....	285
Alert and Aid Mode.....	286
Alert Mode.....	285
Blind Spot Assist - Vehicles With: Blind Spot Information System, Vehicles Without: Trailer Tow.....	286
Blind Spot Assist with Trailer Coverage - Vehicles With: Blind Spot Information System/Trailer Tow.....	288
Lane Keeping System – Troubleshooting.....	291
Lane Keeping System Limitations.....	284
Lane Keeping System Precautions.....	283
Lane Keeping System Settings.....	284
Lane Keeping System – Troubleshooting.....	291
Lane Keeping System – Information Messages.....	291
Launching or Retrieving a Boat or Personal Watercraft - Gasoline.....	321
Live Traffic.....	514
Switching Live Traffic On and Off.....	514
What Is Live Traffic.....	514
Load Carrying.....	310
Roof Rack.....	314
Load Carrying Precautions.....	310
Loading Your Trailer - Gasoline.....	320
Locating the 360 Degree Cameras.....	257
Locating the Blind Spot Information System Sensors.....	293
Locating the Brake Fluid Reservoir.....	225
Locating the Charge Port.....	201

Index

Locating the Cross Traffic Alert Sensors.....	298
Locating the Fuel Filler Funnel.....	186
Locating the Keyless Entry Keypad.....	95
Locating the Power Outlets.....	160
Locating the Pre-Collision Assist Sensors - Vehicles With: Adaptive Cruise Control.....	302
Locating the Pre-Collision Assist Sensors - Vehicles Without: Adaptive Cruise Control.....	302
Locating the Rear View Camera.....	253
Locating the Safety Compliance Certification Labels.....	311
Locating the Tire label.....	410
Locating the USB Ports.....	158
Locating Your Vehicle.....	74
Locking the Steering Wheel.....	100
M	
Maintenance.....	365
12V Battery.....	380
12V Battery – Troubleshooting - Battery Electric Vehicle.....	385
12V Battery – Troubleshooting - Gasoline.....	384
Coolant - Battery Electric Vehicle.....	377
Coolant - Gasoline.....	373
Engine Air Filter - Gasoline.....	372
Engine Oil - Gasoline.....	370
Exterior Bulbs.....	388
Interior Bulbs.....	399
Maintenance Precautions.....	365
Making and Receiving a Phone Call.....	509
Manually Dimming the Interior Mirror.....	114
Manually Releasing the Electric Parking Brake.....	231
Manually Shifting Gears - 10-Speed Automatic Transmission.....	221
Shifting Using the Buttons on the Selector Lever.....	221
Manual Seats.....	145
Adjusting the Head Restraint.....	145
Adjusting the Lumbar Support.....	147
Adjusting the Seat Backrest.....	153
Adjusting the Seat Cushion.....	147
Adjusting the Seat Height.....	147
Folding the Seat Armrest.....	147
Head Restraint Components.....	145
Installing the Head Restraint.....	146
Installing the Seats.....	155
Moving the Seat Backward and Forward.....	146
Removing the Head Restraint.....	146
Removing the Seats.....	153
Swiveling the Seat.....	148
Mobile Communications Equipment.....	576
Mobile Device Data - Vehicles With: SYNC 4.....	28
Motorcraft Parts - 3.5L Duratec.....	454
Motorcraft Parts - 3.5L Ecoboost™.....	455
Motorcraft Parts - Battery Electric Vehicle.....	456
Muting the Audio.....	478
MyKey Settings.....	79
Configurable MyKey Settings.....	79
Non-Configurable MyKey Settings.....	79
MyKey – Troubleshooting.....	81
MyKey – Frequently Asked Questions.....	83
MyKey – Information Messages.....	81
MyKey™.....	79
MyKey Settings.....	79
MyKey – Troubleshooting.....	81
N	
Navigation Map Updates.....	514
Navigation.....	514
Adjusting the Map.....	514
Live Traffic.....	514
Route Guidance.....	515
Setting a Destination.....	514
Waypoints.....	515
Normal Scheduled Maintenance - Battery Electric Vehicle.....	533
Normal Scheduled Maintenance - Gasoline.....	530

Index

O	
Off-Road Driving - Vehicles With: Trail Package.....	329
After Driving Your Vehicle Off-Road.....	330
Basic Off-Road Driving Techniques.....	329
Off-Road Driving Precautions.....	329
What Is Off-Road Driving.....	329
Opening and Closing the Flip Key.....	73
Opening and Closing the Hood.....	365
Opening and Closing the Windows.....	112
Opening the Sliding Door.....	91
Opening the Sliding Door From Inside Your Vehicle.....	91
Opening the Sliding Door From Outside Your Vehicle.....	91
Operating the Doors From Inside Your Vehicle.....	86
Opening the Doors From Inside Your Vehicle.....	87
Opening the Rear Doors From Inside Your Vehicle in an Emergency.....	87
Unlocking and Locking the Doors Using the Central Locking.....	86
Operating the Doors From Outside Your Vehicle.....	85
Opening and Closing the Doors.....	85
Unlocking and Locking the Doors Using the Key Blade.....	85
Unlocking and Locking the Doors Using the Remote Control.....	85
Ordering a Canadian French Owner's Manual.....	539
OTA	
See: Software Update Settings.....	518
See: Vehicle Software Updates.....	518
Overhead Storage.....	169
Locating the Overhead Storage.....	169
Overhead Storage Load Capacities.....	169
Overriding Reverse Brake Assist.....	235
Overriding the Set Speed.....	270
Over the air	
See: Software Update Settings.....	518
Over-the-air	
See: Software Update Settings.....	518
See: Vehicle Software Updates.....	518
See: Vehicle Software Updates.....	518
P	
Parking Aid Indicators.....	250
Parking Aid Precautions.....	246
Parking Aids.....	246
Front Parking Aid.....	248
Parking Aids – Troubleshooting.....	250
Rear Parking Aid.....	247
Side Parking Aid.....	249
Parking Aids – Troubleshooting.....	250
Parking Aids – Information	
Messages.....	250
Parking Brake Audible Warning.....	228
Parking Brake.....	228
Parking Brake – Troubleshooting.....	228
Parking Brake – Troubleshooting.....	228
Parking Brake – Information	
Messages.....	228
Parking Brake – Warning Lamps.....	228
Passive Anti-Theft System.....	97
Arming the Passive Anti-Theft System.....	97
Disarming the Passive Anti-Theft System.....	97
What Is the Passive Anti-Theft System.....	97
Pedestrian Alert System.....	70
Pedestrian Alert System – Troubleshooting.....	70
Pedestrian Alert System – Troubleshooting.....	70
Pedestrian Alert System – Information	
Messages.....	70
Perchlorate.....	576
Performing a System Reset.....	520
Personalized Settings.....	125
Changing the Instrument Cluster Display Language.....	125
Changing the Measurement Unit.....	126
Changing the Temperature Unit.....	126
Changing the Tire Pressure Unit.....	126
Switching the Instrument Cluster Display Audible Warnings On and Off.....	126
Personal Safety System	
Components.....	59
Personal Safety System™.....	59
Phone Menu.....	507
Phone.....	507

Index

Phone Precautions.....	507
Playing Media Using Bluetooth®.....	511
Playing Media Using the USB Port - Vehicles With: SYNC 4.....	158
Playing or Pausing the Audio Source.....	477
Post-Collision Braking.....	342
Post-Crash Alert System.....	342
How Does the Post-Crash Alert System Work.....	342
Post-Crash Alert System Limitations.....	342
Switching the Post-Crash Alert System Off.....	342
What Is the Post-Crash Alert System.....	342
Power Gauge - Battery Electric Vehicle.....	118
Powering Off.....	180
Power Outlet Indicators.....	160
Power Outlet Limitations.....	160
Power Outlet.....	160
Power Outlet – Troubleshooting.....	165
Power Outlet Precautions.....	160
Power Outlet – Troubleshooting.....	165
Power Outlet – Frequently Asked Questions.....	166
Power Outlet – Information Messages.....	165
Power Seats.....	148
Adjusting the Head Restraint.....	148
Adjusting the Lumbar Support.....	150
Adjusting the Seat Backrest.....	150
Adjusting the Seat Height.....	150
Head Restraint Components.....	148
Installing the Head Restraint.....	149
Moving the Seat Backward and Forward.....	149
Removing the Head Restraint.....	149
Power-Up See: Software Update Settings.....	518
See: Vehicle Software Updates.....	518
Pre-Collision Assist Limitations.....	301
Pre-Collision Assist Precautions.....	301
Pre-Collision Assist.....	300
Automatic Emergency Braking.....	304
Distance Alert.....	304
Distance Indication.....	303
Forward Collision Warning.....	303
Pre-Collision Assist – Troubleshooting.....	304
Pre-Collision Assist – Troubleshooting.....	304
Pre-Collision Assist – Information Messages.....	304
Pre-Collision Assist – Warning Lamps.....	304
Preparing Your Vehicle for Storage.....	408
Preserving Your High Voltage Battery.....	191
Programming a MyKey.....	80
Programming the Remote Control.....	77
Properly Adjusting the Driver and Front Passenger Seats.....	67
Protecting the Environment.....	30
Puncture See: Changing a Flat Tire - Battery Electric Vehicle.....	444
See: Changing a Flat Tire - Gasoline.....	434
Push Button Ignition Switch.....	171
Pushing the Parking Brake Lever Down.....	229
R	
Radio Frequency Certification Labels.....	541
Audio Unit.....	541
Blind Spot Information System Sensors.....	542
Body Control Module.....	549
Cruise Control Module.....	552
Keys and Remote Controls.....	556
Passive Anti-Theft System.....	559
Radio Transceiver Module.....	563
SYNC.....	566
Telematics Control Unit.....	572
Tire Pressure Monitoring System Sensors.....	575
Rear Axle Fluid Capacity and Specification - Gasoline.....	468
Rear Cargo Area Anchor Points.....	315
Locating the Rear Cargo Area Anchor Points.....	315
Rear Cargo Area Anchor Point Load Capacities.....	315

Index

Rear Cargo Area Anchor Point Precautions.....	315
Rear Cargo Area.....	315
Rear Cargo Area Anchor Points.....	315
Rear Occupant Alert System Audible Warnings.....	157
Rear Occupant Alert System Indicators.....	157
Rear Occupant Alert System Limitations.....	156
Rear Occupant Alert System Precautions.....	156
Rear Occupant Alert System.....	156
Rear Parking Aid.....	247
Locating the Rear Parking Aid Sensors.....	247
Rear Parking Aid Audible Warnings.....	248
Rear Parking Aid Limitations.....	247
What is the Rear Parking Aid.....	247
Rear Passenger Climate Control.....	143
Rear Seat Precautions.....	152
Rear Seats.....	152
Manual Seats.....	152
Rear View Camera Guide Lines.....	253
Rear View Camera Limitations.....	252
Rear View Camera Precautions.....	252
Rear View Camera.....	252
Rear View Camera Settings.....	254
Rear View Camera Settings.....	254
Switching Rear View Camera Delay On and Off.....	254
Switching Rear View Camera Object Distance Indicator On and Off.....	254
Zooming the Rear View Camera In and Out.....	254
Rebooting the Center Display.....	502
Recovery Towing.....	343
Accessing the Rear Towing Point.....	343
Recycling and Disposing of the High Voltage Battery.....	192
Refueling.....	187
Refueling System Overview.....	187
Refueling Your Vehicle.....	187
Releasing the Electric Parking Brake if the Vehicle Battery Has Run Out of Charge.....	232
Releasing the Parking Brake.....	228
Remote Control Limitations.....	73
Remotely Starting and Stopping the Vehicle - Battery Electric Vehicle.....	131
Remotely Starting and Stopping the Vehicle - Gasoline.....	130
Remote Start Limitations - Battery Electric Vehicle.....	130
Remote Start Limitations - Gasoline.....	130
Remote Start.....	130
Remote Start Settings.....	131
Removing the Key Blade - Vehicles With: Push Button Start.....	73
Removing Your Vehicle From Storage.....	409
Repairing Minor Paint Damage.....	407
Replacement Parts Recommendation.....	576
Replacing a Lost Key or Remote Control.....	77
Replacing the Front Wiper Blades.....	102
Reporting Safety Defects in Canada.....	540
Reporting Safety Defects in the United States.....	540
Reprogramming the Unlocking Function.....	88
Resetting Driver Alert.....	308
Resetting Ground Fault Detection.....	164
Resetting the Individual Trip Values.....	129
Resetting the Trip Computer.....	129
Resetting Tire Pressure Monitoring System.....	431
Restarting the Vehicle After Powering Off.....	180
Resuming the Set Speed Limit.....	278
Resuming the Set Speed.....	264
Reverse Brake Assist Indicators.....	235
Reverse Brake Assist Precautions.....	234
Reverse Brake Assist.....	234
Reverse Brake Assist – Troubleshooting.....	236
Reverse Brake Assist – Troubleshooting.....	236
Reverse Brake Assist – Frequently Asked Questions.....	237
Reverse Brake Assist – Information Messages.....	236

Index

Roadside Assistance - Battery Electric Vehicle.....	336
Roadside Assistance - Gasoline.....	335
Rollover Warning.....	538
Roof Rack.....	314
Roof Rack Load Capacities.....	314
Roof Rack Precautions.....	314
Route Guidance.....	515
Adjusting the Guidance Prompt Volume.....	515
Canceling Route Guidance.....	515
Repeating an Instruction.....	515
Running-In	
See: Breaking-In.....	331
Running Out of Fuel.....	186
Adding Fuel From a Portable Fuel Container.....	186
Filling a Portable Fuel Container.....	186
S	
Satellite Radio.....	483
Locating the Satellite Radio Identification Number.....	483
Satellite Radio Limitations.....	483
Satellite Radio Settings.....	483
What Is Satellite Radio.....	483
Scheduled Maintenance.....	524
Scrolling Through Menu Items - Vehicles With: SYNC 3 Lite, Vehicles Without: SYNC.....	478
Scrolling Through Menu Items - Vehicles With: SYNC 4.....	478
Seatbelt Extensions.....	57
Seatbelt Precautions.....	51
Seatbelt Reminder.....	54
Checking Seatbelt Status.....	57
How Does the Seatbelt Reminder Work.....	54
Seatbelt Reminder Audible Warnings.....	56
Seatbelt Reminder Indicators.....	56
Switching the Seatbelt Reminder On and Off.....	56
Seatbelts.....	51
Automatic Locking Mode.....	52
Seatbelt Reminder.....	54
Sensitive Locking Mode.....	52
SecuriCode	
See: Keyless Entry Keypad.....	95
Security.....	97
Anti-Theft Alarm System.....	97
Passive Anti-Theft System.....	97
Security - Troubleshooting.....	98
Security - Troubleshooting.....	98
Security - Frequently Asked Questions.....	99
Security - Information Messages.....	98
Selecting a Drive Mode - Vehicles With: SYNC 3 Lite, Vehicles Without: SYNC.....	275
Selecting a Drive Mode - Vehicles With: SYNC 4.....	275
Selecting a Menu Item - Vehicles With: SYNC 3 Lite, Vehicles Without: SYNC.....	479
Selecting a Menu Item - Vehicles With: SYNC 4.....	479
Selecting the Audio Source - Vehicles With: SYNC 3 Lite.....	477
Selecting the Audio Source - Vehicles With: SYNC 4.....	477
Selecting the Audio Source - Vehicles Without: SYNC.....	477
Sensitive Locking Mode.....	52
How Does Sensitive Locking Mode Work.....	52
What is Sensitive Locking Mode.....	52
Service Data - Battery Electric Vehicle.....	26
Service Data - Gasoline.....	25
Setting a Destination.....	514
Setting a Destination Using a Point of Interest.....	515
Setting a Destination Using a Predictive Destination.....	515
Setting a Destination Using a Recent Destination.....	515
Setting a Destination Using a Saved Destination.....	515
Setting a Destination Using the Map Screen.....	515
Setting a Destination Using the Text Entry Screen.....	514
Setting a Memory Preset.....	478
Settings Data.....	27

Index

Setting the Adaptive Cruise Control Gap.....	269
Setting the Adaptive Cruise Control Speed.....	268
Setting the Blower Motor Speed.....	134
Setting the Charging Schedule and Preferences.....	208
Setting the Clock and Date - Vehicles With: SYNC 3 Lite.....	480
Setting the Clock and Date - Vehicles With: SYNC 4.....	479
Setting the Clock and Date - Vehicles Without: SYNC.....	479
Setting the Cruise Control Speed.....	263
Setting the High Voltage Battery Reserve Limit.....	164
Setting the Speed Limit.....	278
Setting the Speed Sign Recognition Speed Tolerance.....	307
Setting the Speed Sign Recognition Speed Warning.....	307
Setting the Temperature.....	135
Setting the Wake Word.....	503
Shifting Your Immobile Vehicle Out of Park (P) - 10-Speed Automatic Transmission.....	219
Shifting Your Immobile Vehicle Out of Park (P) - 1-Speed Automatic Transmission.....	218
Shifting Your Vehicle Into Gear - 1-Speed Automatic Transmission.....	217
Side Parking Aid.....	249
Locating the Side Parking Aid Sensors.....	249
Side Parking Aid Audible Warnings.....	250
Side Parking Aid Limitations.....	249
What is the Side Parking Aid.....	249
Signing In as a Driver.....	517
Signing In to Your Account.....	505
Sitting in the Correct Position.....	144
Sliding Door Precautions.....	91
Sliding Door.....	91
Closing the Sliding Door.....	92
Opening the Sliding Door.....	91
Software Update Indicators.....	519
Software Update Settings.....	518
Software Update See: Software Update Settings.....	518
See: Vehicle Software Updates.....	518
Sounding the Panic Alarm.....	74
Special Operating Conditions Scheduled Maintenance.....	535
Speed Control See: Cruise Control.....	263
Speed Limiter Audible Warnings.....	279
Speed Limiter Indicators.....	279
Speed Limiter Precautions.....	278
Speed Limiter.....	278
Speedometer.....	119
Speed Sign Recognition Indicators.....	306
Speed Sign Recognition Limitations.....	306
Speed Sign Recognition Precautions.....	306
Speed Sign Recognition Speed Sign Recognition – Troubleshooting.....	307
Speed Sign Recognition – Troubleshooting.....	307
Speed Sign Recognition – Information Messages.....	307
Stability Control Indicator.....	244
Stability Control.....	243
Starter Switch See: Ignition Switch.....	170
Starting and Powering Off Precautions.....	180
Starting and Powering Off.....	180
Starting and Powering Off – Troubleshooting.....	182
Vehicle Power Down Timer.....	181
Starting and Powering Off – Troubleshooting.....	182
Starting and Powering Off – Frequently Asked Questions.....	182
Starting and Stopping the Engine – Precautions.....	170
Starting and Stopping the Engine.....	170
Automatic Engine Stop - Vehicles With: Push Button Start.....	175
Engine Block Heater.....	173
Starting and Stopping the Engine – Troubleshooting.....	176

Index

Starting the Engine.....	171	Switching Apple CarPlay On and Off.....	512
Stopping the Engine.....	174	Switching Auto Hold On and Off.....	239
Starting and Stopping the Engine – Troubleshooting.....	176	Switching Blind Spot Information System On and Off.....	293
Starting and Stopping the Engine – Frequently Asked Questions.....	178	Switching Climate Control On and Off.....	133
Starting and Stopping the Engine – Information Messages.....	177	Switching Cross Traffic Alert On and Off.....	298
Starting and Stopping the Engine – Warning Lamps.....	176	Switching Cruise Control On and Off.....	263
Starting the Engine.....	171	Switching Defrost On and Off.....	133
Restarting the Engine After Stopping It.....	172	Switching Driver Alert On and Off.....	308
Starting a Flooded Engine.....	172	Switching From Adaptive Cruise Control to Cruise Control.....	270
Starting a Gasoline Engine.....	171	Switching From Intelligent Speed Limiter to Speed Limiter.....	282
Starting the Vehicle.....	180	Switching Maximum Cooling On and Off.....	134
Status Bar.....	501	Switching Maximum Defrost On and Off.....	133
Steering.....	245	Switching Parking Aid On and Off - Vehicles With: SYNC 3 Lite, Vehicles Without: SYNC.....	247
Electric Power Steering.....	245	Switching Parking Aid On and Off - Vehicles With: SYNC 4.....	247
Steering – Troubleshooting.....	245	Switching Rear Occupant Alert System On and Off.....	156
Steering – Troubleshooting.....	245	Switching Recirculated Air On and Off.....	133
Steering – Information Messages.....	245	Switching Reverse Brake Assist On and Off.....	235
Steering – Warning Indicators.....	245	Switching Stability Control On and Off.....	243
Steering Wheel.....	31	Switching Text Message Notification On and Off.....	510
Stopping the Engine.....	174	Switching the 180 Degree Camera On and Off.....	256
Stopping the Engine When Your Vehicle is Moving.....	174	Switching the 360 Degree Camera On and Off.....	259
Stopping the Engine When Your Vehicle is Stationary.....	174	Switching the 360 Degree Camera View.....	259
Storage.....	169	Switching the Audio Unit On and Off.....	477
Bottle Holders.....	169	Switching the Display On and Off - Vehicles With: SYNC 3 Lite, Vehicles Without: SYNC.....	481
Overhead Storage.....	169		
Storing a First Aid Kit.....	347		
Storing a Warning Triangle.....	347		
Storing Your Vehicle.....	408		
Switching Active Park Assist On and Off - Vehicles With: SYNC 3 Lite, Vehicles Without: SYNC.....	260		
Switching Active Park Assist On and Off - Vehicles With: SYNC 4.....	260		
Switching Adaptive Cruise Control On and Off.....	268		
Switching Air Conditioning On and Off.....	133		
Switching All of the Interior Lamps On and Off.....	110		
Switching Android Auto On and Off.....	513		

Index

Switching the Display On and Off - Vehicles With: SYNC 4.....	481
Switching the Electric Heater On and Off - Battery Electric Vehicle.....	134
Switching the Hazard Flashers On and Off.....	339
Switching the Heated Mirrors On and Off - Vehicles With: Heated Rear Window.....	135
Switching the Heated Mirrors On and Off - Vehicles Without: Heated Rear Window.....	134
Switching the Heated Rear Window On and Off.....	134
Switching the Intelligent Speed Limiter On and Off.....	280
Switching the Lane Keeping System Mode.....	284
Switching the Lane Keeping System On and Off.....	284
Switching the Passenger Airbag On and Off.....	63
Switching the Rear Power Outlet On and Off.....	163
Switching the Speed Limiter On and Off.....	278
Switching Traction Control On and Off - Vehicles With: SYNC 3 Lite, Vehicles Without: SYNC.....	241
Switching Traction Control On and Off - Vehicles With: SYNC 4.....	241
Symbols Glossary.....	20
Symbols Used on Your Vehicle.....	20
SYNC™ Applications and Services.....	489
SYNC™.....	485
General Information.....	485
SYNC™ Troubleshooting.....	491
System Update See: Software Update Settings.....	518
See: Vehicle Software Updates.....	518
T	
Tachometer - Gasoline.....	118
Technical Specifications See: Capacities and Specifications.....	452
Temporary Neutral Mode - 1-Speed Automatic Transmission.....	221
Entering Temporary Neutral Mode.....	222
Exiting Temporary Neutral Mode.....	222
How Does Temporary Neutral Mode Work.....	221
Temporary Neutral Mode Limitations.....	221
The Better Business Bureau Auto Line Program.....	538
The Mediation and Arbitration Program.....	539
Third Party Software Copyright Acknowledgment.....	541
Tire Care.....	421
Tire Pressure Monitoring System Limitations.....	430
Tire Pressure Monitoring System Overview.....	429
Tire Pressure Monitoring System Precautions.....	430
Tire Pressure Monitoring System.....	429
Tire Pressure Monitoring System - Troubleshooting.....	432
Tire Pressure Monitoring System - Troubleshooting.....	432
Tire Pressure Monitoring System - Information Messages.....	433
Tire Pressure Monitoring System - Warning Lamps.....	432
Tire Replacement Requirements.....	417
Tire Rotation.....	427
Towing a Trailer Limitations - Gasoline.....	320
Towing a Trailer Precautions - Battery Electric Vehicle.....	319
Towing a Trailer Precautions - Gasoline.....	319
Towing a Trailer.....	319
Towing Weights and Dimensions.....	322
Towing Weights and Dimensions.....	322
Calculating the Maximum Loaded Trailer Weight for Your Vehicle.....	323
Recommended Towing Weights.....	322
What Is the Maximum Loaded Trailer Weight.....	323
Towing Your Vehicle Precautions.....	346
Towing Your Vehicle.....	346
Traction Control Indicator.....	241

Index

Traction Control.....	241	Using the Integrated Trailer Brake Controller.....	324
Traction Control – Troubleshooting.....	242	Using the Keyless Entry Keypad.....	96
Traction Control – Troubleshooting.....	242	Using This Publication.....	19
Traction Control – Information Messages.....	242	Using Voice Recognition.....	486
Traction Control – Warning Lamps.....	242	Using Winter Tires.....	419
Trailer Brake Precautions - Gasoline.....	319	Using Your Vehicle App and Charging.....	206
Trailer Sway Control Precautions.....	328	V	
Trailer Sway Control.....	328	Vehicle Care.....	403
Trailer Towing Hints - Gasoline.....	320	Cleaning the Exterior.....	403
Trailer Towing Navigation.....	516	Cleaning the Interior.....	405
Transporting the Vehicle.....	344	Vehicle Charging Status.....	128
Trip Computer.....	129	Vehicle Identification Number.....	470
Trip Data.....	129	Locating the Vehicle Identification Number.....	470
Trip Summary.....	128	Vehicle Identification Number Overview.....	470
U		Vehicle Identification.....	470
Under Hood Fuse Box.....	348	Vehicle Identification Number.....	470
Accessing the Under Hood Fuse Box.....	348	Vehicle Power Down Timer.....	181
Identifying the Fuses in the Under Hood Fuse Box.....	349	How Does the Vehicle Power Down Timer Work.....	181
Under Hood Overview - 3.5L Duratec.....	367	Overriding the Vehicle Power Down Timer.....	181
Under Hood Overview - 3.5L EcoBoost™.....	368	Switching the Vehicle Power Down Timer On and Off.....	181
Under Hood Overview - Battery Electric Vehicle.....	369	What Is the Vehicle Power Down Timer.....	181
USB Ports.....	158	Vehicle Range Display - Battery Electric Vehicle.....	119
Using Alexa Built-In.....	505	Vehicle Software Updates.....	518
Using Auto Hold.....	239	Vehicle System Reset.....	520
Using FordPass and Charging.....	213	Vehicle Wi-Fi Hotspot – Troubleshooting.....	476
Using Keyless Entry.....	93	Vehicle Wi-Fi Hotspot – Frequently Asked Questions.....	476
Using MyKey With Remote Start Systems.....	81	Vehicle Wi-Fi Hotspot.....	475
Using Progressive Range Selection - 10-Speed Automatic Transmission.....	220	Vehicle Wi-Fi Hotspot – Troubleshooting.....	476
Using Snow Chains.....	419	Ventilation	
Using SYNC™ With Your Media Player.....	491	See: Climate Control - Vehicles With: Automatic Temperature Control.....	133
Using SYNC™ With Your Phone.....	488	See: Climate Control - Vehicles With: Manual Temperature Control.....	139
Using the Cigar Lighter.....	168		
Using the Instrument Cluster Display Controls.....	125		

Index

Viewing the Instantaneous Efficiency Level.....	277
Viewing the Tire Pressures.....	431
Viewing the Trip Summary.....	277
Visual Search.....	31
Voice Interaction Examples.....	503
Voice Interaction.....	503

W

Warnings and Notes Used in This Publication.....	19
Warranty Information.....	604
Washer Fluid Specification.....	467
Washers.....	102
Adding Washer Fluid.....	103
Switching the Courtesy Wipe On and Off.....	103
Using the Windshield Washer.....	102
Washer Precautions.....	102
Washers	
See: Wipers and Washers.....	101
Waxing Your Vehicle.....	407
Waypoints.....	515
Adding a Waypoint.....	515
Editing Waypoints.....	515
What Are the Instrument Cluster Indicators.....	123
What Are the Instrument Cluster Warning Lamps.....	120
What Is 911 Assist.....	71
What Is AC Charging.....	193
What Is a Connected Vehicle - Battery Electric Vehicle.....	471
What Is a Connected Vehicle - Gasoline.....	471
What Is Active Park Assist.....	260
What is Alexa Built-In.....	505
What Is Blind Spot Information System.....	292
What Is Cross Traffic Alert.....	297
What Is Cruise Control.....	263
What is DC Charging.....	193
What Is Drive Mode Control.....	275
What Is Driver Alert.....	308
What Is Eco Coach.....	277
What Is Ford Protect.....	522
What Is Hill Start Assist.....	238

What Is Keyless Entry.....	93
What Is MyKey.....	79
What Is Pre-Collision Assist.....	300
What Is Remote Start.....	130
What Is Reverse Brake Assist.....	234
What Is Speed Sign Recognition.....	306
What Is Stability Control.....	243
What Is the 180 Degree Camera.....	256
What Is the 360 Degree Camera.....	257
What Is the Catalytic Converter.....	190
What Is the Electric Parking Brake.....	231
What Is the Gross Axle Weight Rating.....	311
What Is the Gross Combined Weight Rating.....	311
What Is the Gross Vehicle Weight Rating.....	311
What Is the High Voltage Battery.....	191
What Is the Integrated Trailer Brake Controller.....	324
What Is the Intelligent Speed Limiter.....	280
What Is the Keyless Entry Keypad.....	95
What Is the Lane Keeping System.....	283
What Is the Pedestrian Alert System.....	70
What Is the Personal Safety System.....	59
What Is the Power Outlet.....	160
What is the Rear Occupant Alert System.....	156
What Is the Rear View Camera.....	252
What Is the Tire Pressure Monitoring System.....	429
What Is Traction Control.....	241
What is Voice Interaction.....	503
Wheel and Tire Information.....	410
Wheel Nuts.....	451

Index

Wi Fi	
See: Changing the Vehicle Wi-Fi Hotspot Name or Password - Vehicles With: SYNC 4.....	475
See: Connecting the Vehicle to a Wi-Fi Network - Vehicles With: SYNC 3 Lite.....	472
See: Connecting the Vehicle to a Wi-Fi Network - Vehicles With: SYNC 4.....	472
See: Creating a Vehicle Wi-Fi Hotspot - Vehicles With: SYNC 4.....	475
See: Vehicle Wi-Fi Hotspot.....	475
Window Bounce-Back.....	112
Overriding Window Bounce-Back.....	112
Resetting Window Bounce-Back.....	113
What Is Window Bounce-Back.....	112
Windows.....	112
Window Bounce-Back.....	112
Wipers and Washers – Troubleshooting.....	103
Wipers and Washers – Frequently Asked Questions.....	103
Wipers and Washers – Warning Lamps.....	103
Wipers and Washers.....	101
Autowipers.....	101
Washers.....	102
Wipers.....	101
Wipers and Washers – Troubleshooting.....	103
Wipers.....	101
Switching Windshield Wipers On and Off.....	101
Wiper Precautions.....	101

